

# THE ENERGY EVOLUTION



Harnessing Free Energy  
from Nature

**Viktor Schauberg**

*Translated and edited by Callum Coats*

VOLUME FOUR OF ECO-TECHNOLOGY

# Contents

INTRODUCTION	viii
SOURCES	xiii
1. SOME PHILOSOPHICAL ASPECTS OF NATURAL ENERGIES	1
From Special Edition Mensch und Technik, Vol. 2, 1993, section 7.4	1
From Special Edition Mensch und Technik, Vol. 2, 1993, section 3.1	3
Conclusions	5
The Biological Vacuum - The Optimal Driving Force for Machines	9
The Catalysts	21
Cadaverine Poison in Ray-Form (Ptomaine Radiation)	28
The pressure turbine	28
The suction turbine	32
2. NEW FORMS OF TEMPERATURE	37
A Brief Description of My Discovery	37
Bio-Technology: Active & Reactive Temperatures	39
The Life-Current in Air & Water	41
3. NEW FORMS OF MOTION AND ENERGY	56
The Reactive Fuel Economy	56
The Practical Application of Cycloid-Space-Curve-Motion arising from Processes of Cold Oxidation	61
The Economy Founded on Reactively Produced Energy	65
Explosion and Implosion (Expansion and Impansion)	73
4. NEW VIEWS OF ELECTROMAGNETISM	75
Magnetism - Electricism	75
Magnetism = the Function of Levitism and Electricism = the Function of Gravitism	80
5. THE NATURE OF WATER, ITS CONDUCTION AND USE FOR TRANSPORT	87
Letter to Werner Zimmermann. June 20th 1936	87
The Ennoblement of Water	90

The Transport of Ore in Double-Spiral-Flow Pipe	92
The Liquefaction of Coal by Means of Cold Flows	95
Patent for: Pipe for Liquid and Gaseous Media	104
Patent for: Processes and Equipment for the Conveyance of Liquid, Gaseous or Aeriform Media	107
<b>6. THE AIR TURBINE</b>	<b>115</b>
Letter To Werner Zimmermann	115
The Vacuum Turbine	117
The Formation and Composition Of Riverwater	117
Re: The Air Turbine (Austrian Patent No. 145141 - 15.03.1935)	119
An Air-Turbine Patent	121
<b>7. EARLY DEVELOPMENTS IN IMPLOSION MACHINES</b>	<b>124</b>
From Special Edition Mensch und Technik, Vol. 2, 1993, section 7.4.	124
The Atom Transforming Machine	125
7.7.7: Notes from 15th July 1936	125
7.7.2: Notes from 24th July 1936	126
7.7.3: Notes from the 25th July 1936	126
7.7.4: Notes from the 27th July 1936	127
7.7.5: Notes from the 1st of August 1936	127
7.7.6: Notes from the 11th of August 1936	127
7.7.7: Notes from the 13th of August 1936	128
7.7.8: Notes from the 14th of August 1936	128
7.7.9: An eye-witness report	129
7.7.10: Report of Arnold Hohl's visit, 14th-17th August 1936 (Arnold Hohl) 120	129
The Implosion Machine: An assembly of extracts from Implosion Magazine Nos. 45, 56, 57, 58,60 & 83.	130
The Space-Energy Turbine	140
<b>8. THE ENNOBLEMENT OF WATER</b>	<b>143</b>
The Artificial Production of Springwater	143
Letter to Dr W Biisselberg	147
Blood & Sap Circulation as a Model for the Ennoblement of Water	148
Petrol (Gasoline) from Water	151
<b>9. MACHINES OF THE GENUS - REPULSATOR</b>	<b>155</b>
The Production and Advantages of Implosion Machines	155
The Production of Noble Water & Drinking Water : An Assembly of Pertinent Data from Implosion Magazine	157
A Water-Ennobling Device must satisfy the Following Criteria	159

The Treatment of Water in the Preparation of Noble Water	160
Instructions from data provided by Viktor Schauburger	161
Ingredients Required for about 10 Litres of Water	163
10. THE KLIMATOR	164
Cold and Hot Machines - Cooling-Heating Machines	164
The Klimator - a New Form of Synthesising Current produced by a Space-Energy Generator	166
Technology & Bio-Technology	170
The Naturalesque Ur-Generation of Power, Heat and Light	170
11. MACHINES OF THE GENUS - REPULSINE	177
The Repulsine	177
The Suction Turbine	181
Elaborations on the Suction Turbine	184
Un-Natural Motion - Embryonic Death	186
Application for Patent No. 146 141	189
12. LAST LETTERS FROM VIKTOR SCHAUBERGER	196
Excerpt from Patent Letter to Munich Patent Office	196
Excerpts from Letter No. 1 to Josef Brunnader	198
Excerpts from Letter No. 2 to Josef Brunnader	200
Excerpts from Letter No. 3 to Josef Brunnader	203
Excerpts from Letter No. 4 to Josef Brunnader	206
Excerpts from Letter No. 5 to Josef Brunnader	208
Excerpts from Letter No. 6 to Josef Brunnader	211
Excerpts from Letter No. 7 to Josef Brunnader	214
Letter To Mr 'R'	216
13. THE POPEL REPORT	219
The Preliminary Investigation of Helicoid Pipes: Foreword	219
Report Concerning the Preliminary Investigation of Helicoid Pipes with Various Shapes of Pipe-Wall	222
The Multiple In-Winding, Convoluting Flow Process	223
The Influence of the Form and the Material of the Pipe on the Development of In-Winding Flow Processes	227
The Structural Change in the Water as a Consequence of the Multiple In-Winding Flowing Motion	245
The Prevention Of Encrustation	246
Final remarks on report	247
Index	249

# List of Illustrations

Illustration	Fig.	Page
Single water jet experiment	1	11
Spiral water-jet experiment	2	13
Charged water particles - photo	3	15
Preliminary sketch for suction- or trout-turbine	4	18
Suction-turbine rotor - 2 photos	5	19
Viktor Schauberg's microscope evidence - 2 photos	6	20
Abundance-producing wheel (Repulsator)	7	25
The principle of the abundance-producing wheel (The Repulsine)	8	27
The natural tripartite motion of the Earth	9	30
The Mill of God	10	52
3-blade Bio-impeller	11	63
3-blade Bioturbine	12	64
Bioturbine rotor with whorl-pipes	13	64
Comparison between axial—>radial, radial—>axial motion	14	77
The manifestation of physical growth	15	84
Pipe cross-section showing double spiral flows	16	93
Double spiral pipe diagram - patent No. 196680	17	106
Double spiral pipe diagram - multiple patents	18	114
Air-turbine diagram - patent No. 145141	19	123
Water-driven implosion machine	20	133
Air-driven implosion machine	21	134
Bio-technical submarine (2 images)	22	139
The Nuremberg water-jet experiment	23	145
Design principle for the Repulsator	24	158
Repulsator cross-sectional drawing	25	159
Repulsator diagram with cooling coils	26	161
Klimator - sketch	27	165
Klimator - detailed drawing	28	168
Sketches of nozzles	29	183
Repulsine patent No. 146 141 - drawing	30	191
Repulsine patent - photo	31	192

	Fig.	Page
Repulsine patent double membrane - sketch	32	193
Repulsine - 5 images	33	195
Viktor Schauburger's home-power generator - 2 photos	34	201
Possible air-turbine design	35	204
The accelerating stem turns of a skier	36	209
Rotating paramagnet as dynamo	37	213
The effects of relative densities on motion	38	215
The Popel Report		
Test stand No. 1	Diagram 1	224
Test stand No. 2	Diagram 2	226
Arrangement of the test stand	Diagram 3	228
The configuration of the other test-pipes	Diagram 4	229
Measured outputs of straight and helical pipes of different cross-section and wall configuration	Diagram 5	232
Frictional losses at the outlet of the pipes under test	Diagram 6	234
Table 1: Output of straight and spiral pipes	Table 1	235
Table 2: Output and friction losses of straight and spiral test pipes of glass and copper	Table 2	236
Output and flow-velocities of straight and spiral pipes	Diagram 7	237
Output and flow-velocities of straight and spiral pipes	Diagram 8	238
Comparison between the in-winding and turbulent flowing processes in straight and spiral pipes	Diagram 9	239
Suction levels arising from in-winding flowing motion	Diagram 10	242
Suction capacity of the in-winding flowing motion in pipes of various form and different material	Diagram 11	244

# Introduction

Coincidence? Or perhaps not! Standing as we are on the threshold of a new era, the first dawning of a new age, there is an air of expectancy of things imminent and better. In a certain sense this has psychologically programmed us with a willingness to embrace new concepts, to inaugurate and accept far-reaching change. It is also a time to reflect upon the very foundations of what we call 'civilisation' and to reassess their validity and where they have led, taking the good things with us and leaving the bad ones behind. So it seems timely that the radical departure in energy concepts presented here, should be made available now, when the tide of human development is turning and the impetus of this renewing flood can be harnessed to launch Viktor Schauburger's pioneering discoveries into a world more ready than ever before to implement them. At a time also, when the activities of humanity are increasingly seen to be on a head-on collision course with Nature's processes. An alarming increase in the scope and ferocity of so-called 'natural disasters' is forcing us to realise that the future is no longer secure; that other solutions to those presently proposed must quickly be found to remedy the present state of affairs. In my view, these will be largely ineffective unless Viktor Schauburger's important contributions towards the production of virtually free energy and high quality drinking water - the foundation of healthy life - are not taken into account a priori.

What we are concerned with here is an inversion of all that has hitherto been held to be true scientifically and technologically. As obvious as it is true that one cannot wash one's clothes in the same water that soiled them, so too can no new ecotechnology be founded on existing 'laws' and dogma, which have so disastrously failed. While such new departures in thought are usually referred to as 'revolutions', what is involved here is an 'evolution'. This is no form of repetition, a re-cycling of outworn concepts and processes, but an upward movement to totally new and higher levels not only of perception, but also of application of systems of an entirely new dimension and order. It is a movement away from the ceaseless round, the endless unproductive turning or 'revolution' of the wheel, the chief symbol of our technology and a derivative of the geometrical element of the circle. While progress of a sort is made as the wheel turns, the wheel itself does not evolve and always returns

upon itself. Having no in-built capacity for change and transformation it effectively contributes nothing to real evolutive progress.

Implicit in this evolution towards higher perception and a new modus operandi is the necessity to think an octave higher, as Viktor Schauberger so often expresses it. Just how fundamentally we will have to change our way of thinking and acting to achieve this we have yet to discover, although the information contained in this book will provide many of the necessary keys. Once inserted into the lock of evolution, new as yet unimagined vistas will unfold themselves and can become manifest, provided the will and determination are present to enter upon them.

But what it is that must change to permit this to happen? Basically it is a question of the geometrical system so familiar to us. This is the geometry of Euclid and essentially involves the elements of the straight line, circle and point, all of which are perfect forms and therefore unchanging. Such perfection requires no further input from external factors, nor can it productively interact with them and therefore these elements are sterile 'closed' systems. In terms of their physical appearance, these are the cylinders, spheres, wheels, straight shafts, pipes, flat surfaces, etc. in common use today. As transcendental constructs, i.e. belonging not to the physical world but to the realms of mental ideation, these geometrical elements are physically 'unreal' and in their application to the physical world are therefore 'unnatural'. Consequently their use in the construction and operation of today's machines and the energies they produce are in discordance with Nature's laws.

Steeped in the grandeur of Euclidean edifices over the last two millennia and the apparent appropriateness and suitability of Euclidean geometry for all purposes, we must now reappraise our unqualified acceptance of it, for it lies at the very root of our troubles. On earlier European structures the straight lines and hard edges were softened and made pleasing to the eye through their often exuberant embellishment. The Chinese on the other hand, versed in the art of geomancy, constructed their traditional buildings differently, deliberately curving the profile of the roof. In their philosophy the straight line was the path preferred by dragons, the mythical personification of destructive power, whose violence could only be curbed by forcing it to move along curved paths. Intuitively the Chinese were aware that straight lines provoke and foster violent behaviour, a phenomenon on the increase world-wide. Since the beginning of the last century [1900s] there has been a rapid reduction of such visual complexity to one of virtual uniformity as this decoration has gradually been stripped away, reducing our built environment to a naked, stark and arid angularity. Concurrent with this unfortunate development, and aided and abetted by the direct application of such geometry, the supremacy of rational straight-line thinking increased at the expense of the intuitive, the beaching from within, increasingly crippling our perception of



Nature's subtle workings. Because of this the rational mind began to cut out important factors that were deemed extraneous, so as to achieve the most economically effective outcomes. Thus, for instance, the bends in rivers were truncated and the gradient steepened in order to 'improve' Nature's patterns of flow, without any account being taken of their contribution to the health and stability of the river. The result - violent discharges and inundations.

Such simplicities of line not only disturb rivers, they also have a disturbing effect psychologically, because the eye, that most complex of organs requires an equal external visual complexity to maintain its health, balance and stability, transferring such states to the brain and psyche of its host. While contemplation of the rich diversity in colour and form of natural undisturbed forest - an apparent chaos but actually the highest state of order - brings us a sense of peace and inner tranquillity, when we are confronted by plantation forests, planted out in rows of same-age, same-species, same-height, same-shape trees, we experience a certain inner discomfort. A higher state of order and complexity has been reduced to a lower one. While such a relatively small reduction produces such a reaction, what effect do more major reductions have on us psychologically?

If we take the thrust and intention of Viktor Schauberg's inversion of our present reality to its logical conclusion, then it also calls into question the validity of the other artefacts we have produced. If the design, shape and function of today's and earlier devices have produced such unwelcome repercussions on the external environment and our health, what effect has the design of our living spaces had on the internal environment of our minds? As human beings, we are created according to Nature's laws of organics and not those of mechanics. We therefore belong to the world of Nature, to the world of sentient, intelligent creatures. And yet, indoctrinated by history, we do not perceive that the form of our dwellings, our physically enclosing structures, is at odds with those of other creatures; creatures whose sensitivity (which is also our birthright) is such that their intercommunion with the subtlest energies and response to the influences surrounding them is extremely intimate and of an order now almost totally alien to us. No natural creatures live in rigid rectangularities, but in roundnesses and curvilinear forms such as burrows, nests and shells, the latter the product of the most complex systems of curves. While Nature makes use of these forms everywhere, we do not, and through our constant use of unnatural geometry in all areas of endeavour, we have largely estranged ourselves from her. We have never even thought to question the influence that continual exposure to unnatural straight lines may exert on our mental, intellectual and emotional processes, on the energies that motivate and animate us and cause us to behave in one way or another. Such is the de-sensitising effect that perhaps we will have entirely to change our

living spaces in order to make possible the leap to the next higher state of awareness, to be able truly to appreciate Nature's processes and attune ourselves to them.

No doubt it was for all of these reasons that Viktor Schauberg so joyfully declared: "In the whole machine there is no straight line and no circle".<sup>1</sup> By this he meant that the overall design and shape of his devices were founded on completely different parameters to those of current design. Gone are the mortifying elements of Euclid. The effective functional surfaces and forms of these machines incorporate the swirling spirals and sinuosities, the open elements of non-Euclidean geometry so prevalent in Nature. By incorporating such organic spiral configurations and egg-shapes in such devices, energies are produced that are life-affirming in lieu of those generated by conventional machines that are presently inexorably destroying it. These energies and forces have the capacity not only to rehabilitate, enhance and stabilise Nature's energies, but also our own. As cooling revitalising energies, their widespread use would contribute much to the re-establishment of climatic equilibrium, which humanity's unthinking activities have so grossly thrown out of balance.

Whereas in earlier days the technology to manufacture and mass-produce such devices cheaply and economically was not available, today this is no longer the case. With the advance in electronics, the only form of modern technology that emulates Nature's resonances and communicative processes, computer controlled machines can produce forms of virtually any curvilinear complexity. Coupled with the independence of movement, the freedom from hunger and want that Viktor Schauberg's devices can provide and the present sophistication of global communication, humanity could be distributed far more evenly over the surface of this planet. This would remove the environmentally harmful point-loads of cities. Instead of being forced to live as human blood corpuscles, whose purpose is to maintain the flow of life-fluid in our machine-cities, we would be able to devote our energies to the evolvment of our innate creativity and to interact with Nature in the way that was always our birthright. Eventually wholly deserted, the deadly grid-iron conurbations of brick and asphalt would be viewed as the cautionary relics of one of the dark ages of human history, albeit a necessary educative chapter in our evolution and without which this coming corner could not have been turned.

To accomplish this, to swing wide the gateway to fresh fields of positive endeavour, all that is needed as Viktor Schauberg urges is the necessary will.

<sup>1</sup> From Section 7.7.10: Report of Arnold Hohl's visit, 14th-17th August 1936 (Arnold Hohl) in the Special Edition of Mensch und Technik, Vol. 2, 1993. — Ed.

"Our work is the embodiment of our will. The spiritual manifestation of this work is its effect. When such work is properly done it brings happiness, and when carried out incorrectly it assuredly brings misery. Humanity! Your will is paramount! You can command Nature if you but obey her!"<sup>2</sup>

Callum Coats  
February 2000

<sup>2</sup> From "The Road To Free Energy" in *Our Senseless Toil*, published in 1934 by Krystall Verlag, Vienna. — Ed.

# Sources

## Mensch und Technik - naturgemass

Originally Kosmische Evolution or Cosmic Evolution, the German periodical, Mensch und Technik - naturgemass (Humanity & Technology - in accordance with Nature), is funded by private subscription and published by the Gruppe der Neuen, or the New Group, whose aim was to explore Viktor Schauberger's theories and to interpret them scientifically. Volume 2,1993, is devoted entirely to the recently discovered (early 1990's) transcript of a notebook compiled in 1941 by a Swiss, Arnold Hohl, which not only reports on his visits to Viktor Schauberger in 1936 and 1937. It is from this volume that some of the passages in this book are obtained.

## Implosion Magazine

Implosion is a quarterly magazine, funded by private subscription and generally oriented towards the lay reader. It was originally published by Aloys Kokaly from about 1958 and now runs to 127 issues. Kokaly also founded the Verein zur Forderung der Biotechnik e.V. (Association for the Advancement of Biotechnology) specifically for the research and evaluation of Viktor's theories and through Implosion to provide a platform for Viktor Schauberger's various writings, of which Kokaly had many originals due to his close association with Viktor Schauberger during World War II and the immediately post-war period.

## The Schauberger Archives

Forming the greater part of Viktor Schauberger's estate, these are the private archives of the Schauberger family and the PKS (Pythagoras-Kepler-School) at Lauffen, near Bad Ischl in Upper Austria.

## Other Sources

Personal letters from Viktor Schauberger to various individuals.

## Editor's Note

Device identification: The proper identification of Viktor Schauberger's various machines is somewhat problematic, different names being used for

the same or similar machine. On occasion in Viktor's writings reference is made to an accompanying sketch. Regrettably in most cases this is missing, which has made accurate description of the device in question very difficult, the editor having to rely on other descriptions to aid in identification. In general, however, the discussion revolves around the function of four types of machine, namely the Air-turbine, the Repulsator, the Klimator and the Repulsine. As far as it has been possible reasonably to ascertain its proper attribution, all the data relating to each has been assembled under the relevant heading. Despite the confusion that may arise from the appearance of the same name in different chapters, it is to be hoped that in perusing the diagrams and studying the text, the reader will not only obtain a general understanding of the way these various machines function, but also many insights into what elements and shapes should be incorporated into future designs for machines based on implosion dynamics.

Repetitions: In the original German certain passages overlapped and therefore as far as possible avoidable repetition has been removed. However, some passages still remain which the reader may find repetitive. After much deliberation, the editor decided to leave them virtually untouched as there was no way to remove them without disadvantageously affecting the coherence and detailed comprehension of the theme under discussion.

1.

## Some Philosophical Aspects of Natural Energies

"Everything is governed by one law. A human being is a microcosmos, i.e. the laws prevailing in the cosmos also operate in the minutest space of the human being."

Viktor Schaubberger, Implosion Magazine, No. 8, p.6.

"You must look at the processes of motion in the macrocosmos and microcosmos accurately, and copy them!"

Viktor Schaubberger, Implosion Magazine, No. 14, p.19.

"If we wish to influence our own life in a particular direction, which is constantly threatened by the danger of the emergence of alien life-forms, and protect it from deterioration, then we must either allow Nature to rule or, if we wish to intervene, we must first acquaint ourselves with the simplest principles of life."

Viktor Schaubberger, Implosion Magazine, No. 86. p.11.

"All motion consists of two components. One component serves inwardness (internalisation) and the other outwardness (dispersion). Both preconditions for motion regulate the eternal flow of metamorphosis (panta Rhei)."

Viktor Schaubberger, Implosion Magazine, No. 57, p.5.

"Whoever should leave the Earth in an inward direction, enters Nirvana from which there is no return."

Viktor Schaubberger, Implosion Magazine, No. 90, p.8.

From Special Edition Mensch und Technik, Vol. 2,1993, section 7.4.

**W**hat most peoples have so far achieved is no culture, but merely a civilisation and a retreat from the true culture; a journey that was (is) absolutely necessary in order, through experience, to take the next step forwards. To move forwards means to come to grips with temporal

processes. Whatever we meet with, we must consume as it were. We must digest it in our inner being. The product of this process of organic transformation is mental clarity (non-spacial energies) or the pure intuitive perception of the true reality (and the love of our Father). What we formulate with our thoughts alone, consumes and destroys. For this reason today's purely constructive technology has a consumptive effect.

The machines of the future will not destroy their fuel, but direct the energies inwardly. In this way a harmonious motion manifests itself externally, which transmutes the used material organically, exalts it and refashions it one octave higher. The residual material thus becomes endowed with the necessary potency and provided with the possibility to resurrect itself in the succeeding earthly form of life.

Earth, water, air (and light) are organisms, and between them lie the organs of the most diverse nature in a constant state of readiness to act. If we bring these organs together harmoniously; if we place every inner potential opposite its outer harmonic form, then the thing begins to gyrate within and about itself and to evolve, because in rhythmical sequence every impulse is countered by an expulse, through which the harmonic motion gives way to the inflowing and diffusing counter-movement.

The counter-reactive transverse electrical potentials have to be stationed opposite the strongest longitudinal magnetic potentials. Out of this normal state of opposition the harmonic transitional point is created in the golden middle. This golden middle is the organic angle. It is the only true pathway upon which there is no upwards, no downwards, no sideways and no inwards, but only a movement in and about itself, which corresponds to the infinite will of God, the unity in the universality.

Few will understand the meaning of the above! Some individuals, however, will obtain an indefinable inkling. This apprehension is none other than a dreamlike awakening and the incipient apotheosis of the hitherto animal mass. There is no birth without pain. Every death is followed by a birth. What we are experiencing today is a turning-point of time.

Good luck to all those who understand it! Let them find one another as long as there is still time, for we are fast approaching a stupendous event.

Viktor Schauberger, Vienna, May 1936

It has been proven psychologically that human beings can only appreciate or apprise, i.e. comprehend and understand, something new, if they can succeed in raising up the subconscious immured in their brain cells into their higher consciousness. If this cannot be achieved, then all preaching is useless. And even the eye has first to learn how to see everything new; it too must therefore be awoken from its latency before it can grasp the seen. Above all, there must be a readiness to consider even supposed wonders as the forerunners of

forthcoming realities, for only thus can the foundation be laid upon which rational mind can calculate and analyse.

Viktor Schauberger in a letter to Hermann Jaeger, 31st October 1957, Implosion Magazine, No. 103, p. 20.

From Special Edition Mensch und Technik, Vol. 2,1993, section 3.1

It has become clear to some that the origins of all manifestations of life and motion lie in chemo-physical and electromagnetic causes, which on their part are triggered by plus and minus temperatures.

Will and counterwill are functions of the temperatures that arise for one reason or another. Work is a function of the temperatures that lie above or below the turning point or point of intersection - the anomaly point - in which all life arises (zero-point). It is of similar nature to what we experience as the 'present', which is a function of an on-going extremely high velocity flow. This flow is an eternal motion-of-creation, which in turn gives rise to a constant creation-of-motion.<sup>1</sup> Thus we arrive at the fallacy and the explanation

of the life that lies between birth and burial, which is the illusion that clothes evolution with reality. Temperature is thus the difference between differences, out of which the ceaseless movement of evolution arises, which is itself the product of tensions resulting from the contrasting directions of movement.

The movement of the planets is mirrored in the movement of earthly bodies and thus the possibility also exists to order the course of such planetary systems by means of a particular physical motion. Conversely, it is also possible to exploit planetary motion to produce physical motion, which will enable us to harness a constantly waxing motive force for our own use. Opposites have their appointed directions of movement and find their expression in the mutual interaction of living and moving matter.

If we can now succeed in dosing like-directional dynagens<sup>2</sup> and in bringing the groups of substances thus organised into mutually opposing motion, then

<sup>1</sup>Motion-of-creation and creation-of-motion: These terms relate to the German expressions 'Gestaltungsbewegung' and 'Bewegungsgestaltung', which encompass 'Bewegung' meaning 'motion' and the German concept of 'Gestalt' or 'Gestaltung', an expression that in English cannot be translated with a single word. The Collins English Dictionary defines 'Gestalt' as "a pattern or structure possessing qualities as a whole that cannot be described merely as a sum of its parts." As such it can also apply to physical, energetic and spiritual forms, matrices and structures. 'Motion-of-creation' and 'creation-of-motion' could therefore also be respectively interpreted as 'form (or structure) -creating motion' and 'motion-creating form (or structure)'. — Ed.

<sup>2</sup>Dynagen: This is one of three forms of Ethericity, a term that refers to those supra-normal, near non-dimensional, energetic, bio-electric, bio-magnetic, catalytic, high-frequency, vibratory, super-potent entities of quasi-material, quasi-etheric nature belonging to the 4th and 5th dimensions of being. As such these ethericities can be further categorised as fructigens', 'qualigens' and 'dynagens', which respectively represent those subtle energies, whose function is the enhancement of fructification (fructigens), the generation of quality (qualigens) and the amplification of immaterial energy (dynagens). According to their function or location these may be male or female in nature. — Ed.



a maximal motion results, whose harmonic counterpart is the creation of the minimal form of motion, because the latter represents the totality in a single point. This is the turning or anomaly point out of which is born the creation-of-motion from which in turn the self-enclotting motion-of-creation arises.

This physical formation is the product of organic formative processes and it is obvious that in order to construct such physical forms, we must make use of certain basic shapes. This basic shape we find in the ellipse, which once set in motion, produces the mirror-image, opposite form. As the natural counterpart, the latter also creates the opposite temperament or reciprocal temperatures, which on their part give rise to the potentials and the form of motion associated with them.

Since we are here concerned with pure morphological patterns, there can be no state of equilibrium and therefore that state cannot exist, which we understand as 'rest'. In reality this apparent rest is the very highest state of motion and at the same time the point of material transformation, of the ur-generation<sup>3</sup> of the most purely spiritual dimension, which is transformed at the speed of lightning into movement and formation, through which the thing is forcibly turned inside out and is thus energised from within. On the other hand, this two-fold motion is also the origin of life, which on its part continually transforms itself both without and within.

If we should now succeed in maintaining any given substance - water, for instance - in constant state of change and transformation, then we are presented with the eternal, formative movement. This generates the creation-of-motion, which we can transform by indirect means into that which in today's terminology is described as 'energy'. With this we are well on the way to a technology that will usher in and order the coming bio-ecological age.

The basic principle of this natural technology is the frictionless motion that naturally and necessarily results from the creation-of-motion innate in evolution, which as it evolves to a higher state of organisation, automatically

<sup>3</sup> In Viktor Schauburger's writings in German, the prefix 'Ur' is often separated from the rest of the word by a hyphen, e.g. 'Ur-sache' in lieu of 'Ursache', when normally it would be joined. By this he intends to place a particular emphasis on the prefix, thus endowing it with a more profound meaning than the merely superficial. This prefix belongs not only to the German language, but in former times also to the English, a usage which has now lapsed. According to the Oxford English Dictionary, 'ur' denotes 'primitive', 'original', 'earliest', giving such examples as 'ur-Shakespeare' or 'ur-origin'. This begins to get to the root of Viktor's use of it and the deeper significance he placed upon it. If one expands upon the interpretation given in the Oxford English Dictionary, then the concepts of 'primordial', 'primeval', 'primal', 'fundamental', 'elementary', 'of first principle', come to mind, which further encompass such meanings as: — pertaining to the first age of the world, or of anything ancient; — pertaining to or existing from the earliest beginnings;- constituting the earliest beginning or starting point;- from which something else is derived, developed or depends;- applying to parts or structures in their earliest or rudimentary stage; — the first or earliest formed in the course of growth. To this can be added the concept of an 'ur-condition' or 'ur-state' of extremely high potential or potency, a latent evolutionary ripeness, which given the correct impulse can unloose all of Nature's innate creative forces. In the English text, therefore, the prefix 'ur' will also be used wherever it occurs in the original German and the reader is asked to bear the above in mind when reading what follows. — Ed.

vacates the place it occupied and in this way gives rise to the counter-motion of the surplanting body.

## Conclusions

From Spec. Ed. Mensch und Technik, Vol. 2, 1993, section 10.0 (Notes from April 1941) "We must look into unknown dimensions, into Nature, into that incalculable and imponderable life, whose carrier and mediator, the blood of the Earth that accompanies us steadfastly from the cradle to the grave, is water."

Viktor Schauberger, 1932, Implosion Magazine, No. 103, p. 28

"Whoever accelerates the media of earth, water and air centrifugally perishes unconditionally, for in so doing they reduce the Blood of the Earth (water) to a pathogenic state and make it the most dangerous enemy of all living and growing things."

Viktor Schauberger, Implosion Magazine, No. 96, p. 4.

In Nature there are only structures and orifices. From these arise all forms of materialisation and dematerialisation, if orifices and vessels are organised in an inversely symmetrical configuration and within them the reciprocal gaseous substances are correctly dosed. Pressure and suction, and most important of all, the temperature-gradient should be aligned in the right sense (+ not -), through which the desired energy is freed at the point of intersection.

This can be accumulated if the thing is cooled during its motion, becoming homogeneously structured in the process. In this manner it is even possible to decompose ordinary air into animalistic electrical essences, or to produce an artificial thunderstorm, whose transformative essences discharge into metal conductors, calling into being a physical vacuum with which a thunderstorm can be produced in the tube, whose power exceeds that of a cyclone. While it is still necessary to use small quantities of earthly substances in the artificial production of petrol (gasoline), no fuels of any kind are needed to operate the air-turbine<sup>4</sup>. This will avert the crisis that will inevitably ensue if nature-alienated humanity continues to combust substances in its machines, which are preordained by Nature for the provision of food. The seemingly remarkable behaviour of liquids under the influence of light is the totally natural permanent condition of the eternal 'Arising' and 'Passing Away', of the evolution from small to large and vice versa, whose vital harmony Goethe has already explained to us so beautifully that all we need to do is read his works so as to create the perpetual interaction required by all molecules in order to exist in a state of well-behaved order.

Space and volume are inversely disposed opposites, which consume or animate one another depending on whether one is made to burn by the other or

<sup>4</sup> See description of air turbine in Austrian Patent No. 145141, p. 115 of this book. —Ed.

is itself ennobled intrinsically through this reciprocal intensification and polarisation. Today's technology mistakenly chose the former of the two processes and it is therefore no wonder that cancer is on the rampage here, there and everywhere.

Goethe said, "The driving wheels of Nature are polarity and intensification and whoever understands enough to untie also knows enough to bind." What is born in light, disintegrates in the coolness of the ground. It rises up and returns again as a ray of energy in order to quicken that which stands ready to become new life at the boundary between space and volume.

Every leaf is an animalistic magnet in monoplanar form, which attracts and radiates, depending on whether the Sun shines on it or cold caresses it. This great law of reciprocity also operates in water, which constantly restructures itself by altering its space and volume. The space is shaped by light and heat. The volume is a product of darkness and coolness. If we understand how to apportion the opposing relation between space and volume and how to organise its intrinsic structure, then the substance - water - will become 'The Space' and the formless volume its realisation, which is transformed instantaneously with heat-pressure, thereby creating the motion that fills the over-lying inter-space.

If nature-alienated humanity, however, reverses this purposeful process and combusts precisely those substances that occasion life, then they should no longer be surprised when the Sun burns up that which serves it as an intermediate space, and which serves humankind for the maintenance of life.

Life unfolds itself in three spheres:

1. in the Carbone<sup>5</sup>-sphere
2. in the Atmosphere
3. in the Stratosphere

The connection between these spheres is created by water. Conversely, the various states of aggregation of water form the bridges for the formation and reconstitution of the basic elements carried by water, which succeed in reaching the Earth's interior from the stratosphere and vice versa. The purely mechanical circulation of the physical form - water - operates in the opposite direction to the circulation of energy. The rising of the C-substances with their carrier - water - is countered by the sinking of the oxygen. Where these

<sup>5</sup> Carbone: In contrast to the normal use and definition of 'carbon', Viktor Schauberger grouped all the known elements and their compounds, with the exception of oxygen and hydrogen, under the general classification of 'Mother Substances', which he described with the word 'Kohle-stoffe', normally spelt 'Kohlenstoffe' and meaning carbon. Apart from the above definition the hyphen also signifies a higher aspect of carbon, both physically and energetically or immaterially. The additional V in the English word is therefore intended to redefine and enlarge the scope of the usual term 'carbon' in accordance with Viktor's concepts. On occasion carbone will be represented by the term C' differentiate it from the normal term for carbon — C- Ed.

mutually contra-directional currents intersect, energy is freed. These energetic interactions can never reach a state of rest due to the constant variation in the length of night and day. Inevitably therefore, there is a continual shift in the individual microclimatic conditions, which further result in variations in the quantity and quality of the basic elements.

The outcome of this incessant reciprocal activity on the one hand is the reconstitution of the various kinds of water present in the individual zones, and on the other, the constant transformation of the species of vegetation in which water makes its way, ceaselessly moved by this inner interplay of forces. This inner, energetic interaction, however, is opposed by the effect of the water's weight. The alternating magnitudes of these component forces inevitably lead to the constant rising and falling of the water particles - the so-called pulsation of water. Every new formation and all growth is derived from the smallest beginnings. Continuing development in the early stages can only be accomplished if the circulation in the Earth's interior proceeds correctly. According to inner law, every higher form of vegetation is built up from the lower species preceding it. The carrier of the substances and the transmitter of the life-processes in the root-zone is the groundwater. The impulse for its movement is caused by a drop in temperature, to which the inner metabolic processes of the here decisive groups of basic elements give rise. The impulse for the movement of water is thus a product of the interactions between the opposites contained within it, which find their necessary resistance in the water itself. Through the resistance arising from the interactions between carbon and oxygen, fluctuations in temperature again occur and with them the impulse to move - the pulsation of water, which in this way at times dissolves salts and at others deposits them, transports them, creates energies and transforms them. The sense and purpose of these perpetual transformation processes is the creation and maintenance of the various types of vegetation and physical forms, which on their part again represent the bridges for the build-up and maintenance of the energies.

The potential differences in constant existence between inner and outer temperatures are none other than forms of energy, which complete the cycle of water and at the same time kindle it anew. Evolutionary manifestations are therefore,

1. of material, and
2. of immaterial nature.

Stone, plant, animal, human being, planet and Sun are organisms possessed of body and soul. Every ray of light or heat requires a physical form in which it can evolve, or organise itself. Every body requires an inner energy that builds it up or transforms it. When a body disintegrates then those energies

that created it will again be freed. They are never lost. If they lose their place of abode with the decaying of the body, then they are willingly taken up by the water that eternally circulates in, on and above the Earth and which conducts them once more to a new life. Therefore wherever we look there is life, constant formation and transformation. Should we look into apparent emptiness, then a sea of spiritual life, passed and future generations, returns our gaze. Every material form of vegetation is always the reflection of an immaterial form consisting of light, heat and radiation.

Every change in sphere changes the outer and inner relations of the whole, changes the weight and the intensity of the inner radiation of water and thus the direction in which this carrier of life moves. Disturbances to the inner and outer conformities with natural law lead to a disturbance in the organisation of the whole evolution of life. The disappearance of water or its substantial transformation is a very serious warning sign, because the character of the water also changes with its inner composition, and with this the character of all forms of life, including human-beings. The qualitative decline of the vegetation and above all the deterioration of the highest plant-organism - the forest, the psychic and moral degeneration of humankind, are only the legitimate consequence of the disturbance of the physical composition of water and the disruption of the geosphere occasioned by humanity's subversive activity in the organism of the Earth.

What we are experiencing today is no crisis, but rather the demise of the whole, i.e. the qualitative, physical degeneration of all organisms, brought into effect through the disturbance of Nature's water-balance. In step with this devolution goes the moral, mental and spiritual collapse of humanity, which has already reached such an advanced state, that despite all warning signs people still do not recognise the seriousness of the situation. Worse than animals, they seek their final salvation in the decimation of humanity with weapons of war, that our priests even bless along with the banners under which our children are supposed to bleed to death.

The decision, whether we take the latter path or whether at the final hour we can protect ourselves from our own self-mutilation, only lies with us, or with those men of science and the state, who take upon themselves an altogether appalling responsibility, when out of personal interest, with no consideration of the gravity of the situation and being incapable of bringing any effective help, they continue to adhere to their present point of view.

## The Biological Vacuum - The Optimal Driving Force for Machines

An amalgam of articles from Implosion Magazine, Nos. 29 (pp 27-31), 53 (pp. 24-29) & 109 (pp 9-17), written 8th July 1954.

"The scientist states that pressure is exerted outwards in all directions equally, whereas natural pressure (e.g. air pressure) is exerted inwards from all directions equally."

Viktor Schauburger, Implosion Magazine, No. 114, p.29.

A few years ago my so-called pioneering patents were applied for in 26 countries. In almost every country the patent assessors declared that I was mad and some of them even refused to evaluate the patent applications. Of these about half have been granted to date. The remainder are about to be granted, although their possible practical application has not been understood by a single patent assessor. The substantiation of these patent claims, however, could not be refuted in the preliminary assessment. During this period the German patent attorney, who had been preparing my foreign patent applications, told me that all at once there had been second thoughts and that my patents had been granted one after the other. The truth of my observation had thus been recognised as correct. Their granting was therefore compulsory. This change of opinion had been provoked by very strenuous counter-arguments during the preliminary hearings as well as through the publication of various articles in so-called 'serious' scientific journals. As a case in point for example, the magazine 'Das Universum' reported that the smaller Swiss lakes were already as good as ruined, where contemporary turbine systems had been installed in the upper and lower reaches of their affluent streams. Indeed in many large Swiss lakes and in many German and other lakes, the mysterious deterioration of both lake and river water had been elected. In its issue of the 9th of June 1954, the Hamburg periodical 'Der Spiegel' reported that at present at least 10,000 million marks would have to be outlaid in Germany in order to rectify the most blatant depredations in the mismanagement of water resources. The German rivers are polluted to such an extent that even the best filtration plants are virtually useless. An extended period of drought will have catastrophic effects on drinking-water supplies and water for general use. Signs prohibiting bathing and other warnings bear witness to the fact that the spread of infantile paralysis has been traced to a virus that evolves in polluted waters, which are becoming diseased for unknown reasons. The strongest chlorination or other methods of poisoning have not been of much use. All attempts to eradicate the potato beetle and other agricultural pests with poisons have likewise come to nothing. The opposite has occurred, for increasingly pernicious parasites are appearing

against which even penicillin is powerless. The sicker the organism, the more agile its destroyers become.

In the aforementioned patent applications it was stated in no uncertain terms, where the causes of these regressive symptoms, including cancer, were to be sought, which imperil all growth and highly evolved forms of life. In these applications I made the observation that it was the method of moving water techno-academically which in every respect is destructive and which is solely responsible for the economic decline, the rise in social privation and the constant increase in political unrest. Techno-academic motion is so called, because it is taught in all academies and universities in the form of the centrifugence of medial structures (earth, water and air) and in every dictionary it is described as an 'unnatural' (unreal) form of acceleration. In spite of this it is used today in all areas of industry in its exceptionally centrifugating form, because no other method of acceleration is known. It will therefore continue to be used everywhere until a more rational source of power is discovered.

Observations over many years of the almost motionless stationary trout in rushing mountain streams led to the discovery of the best and cheapest source of mechanical power. It is a form of energy that promotes healthy growth and will free humanity from the technology that presently enslaves it. Founded on a biological vacuum, it will provide the basis for a quantitative and qualitative increase in productivity, thereby solving the pressing problem of more and more people and less and less food. The political turmoil now apparent everywhere can easily lead to the third and last World War, which if atom bombs are used, will mean the end of civilisation. This should certainly be reason enough to consider the following seriously even though it may appear utopian at first sight, an aspect that should offer no further impediment once the academic expertise derived from the misinterpretation of fundamentals collapses like a house of cards. Nor should it be rejected because many occupations that are more or less parasitic will be eliminated in the process. We are here concerned with the existence or non-existence of millions of people in all countries of the world.

For more than a century it has been known that water emits ionising radiation, if it is discharged through a system of straight jets under pressure (see figs. 1-3<sup>6</sup>). Hitherto unknown, however, was the following: If these rays are braked by a filter composed of fatty substances (paraffin wax) and conducted in bundled form into a vacuum-tube, then they incandesce on the inner surfaces, producing a dark red, strongly pulsating glow when the tube is earthed. This effect is similar to sheet-lightning. If these rays are amplified in Leyden jars and then conducted into inflammable liquids or gases, they ignite the latter. This is how the fire started in the Hindenburg, which was filled with hydrogen and became earthed when its ballast-water was released. The

<sup>6</sup> This also relates to the effects of Lord Kelvin's influence machine — ca, 1880. - Ed.

American airship, the Akron, which was filled with helium, collapsed (imploded) and crashed on a cool and misty morning, because for hitherto unknown reasons the helium-filling reverted to water. In the first case fire was created and in the second case - water. With fire an approximately 1,800-fold increase in volume occurs, whereas the reverse metamorphosis of helium into water is associated with an 1,800-fold reduction in volume. This reduced volume is the 'biological vacuum', which is the result of chain-reactions and is an ideal source of motive power. In biotechnical machines a vacuum is initially created through the volume-reducing function of the whorl-pipes through which, in a process of repulsion, energy can be drawn off.

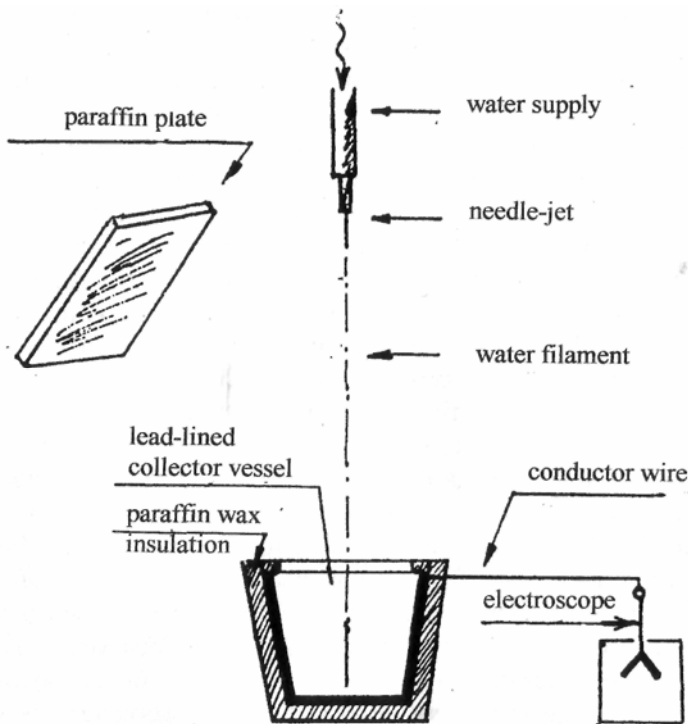

### Schematic Arrangement of Walter Schaubberger's Single Water-Jet Experiment - 1951

Demonstrated in Vienna, London, Cambridge, Oxford and Birmingham, the electroscope reacted when the accumulated charge was reflected back towards the water-filament by the paraffin-wax plate. This reaction occurred even when the paraffin-wax plate was held up at a distance of 20 metres from the water filament.

Fig. 1



Through Patent No. 1.057.676<sup>7</sup> granted by the French Patent Office, who accepted it in an almost unabridged form, the OEEC was made aware of my views, which in this way came to the attention one of the foremost water and air research institutes. Via a Viennese intermediary, my advice was sought as to whether this could explain the apparently unstoppable increase in the infection and decay of water, sap and blood, which is also responsible for every kind of water catastrophe. The actual impetus for these enquiries arose as a result of Professor Otto Warburg's study of cancerous tumours under the microscope. He determined that they were nourished principally by oxygen<sup>8</sup>. Plants too are supposed to obtain up to 80% of their nutrients from the positively overcharged atmosphere.

I reject this assertion, because oxygen is no nutrient, but the substance that fertilises the oppositely-charged (geospheric) fructigenic ethericities. These enter the plants via the protoplasm at the tips of the roots (see fig. 15). In more highly organised life-forms they enter the hermetically sealed blood- or sap-streams by way of the intestinal filtration systems; in other words, by way of diffusion. They then proceed through the diffusive orifices of the leaves, needles, gills and lungs and make possible the intermixtures upon whose character and capacity of accommodation the formation of pathogenic or animating entities depends, which at this time are in an atomic state.

Animating energies come into being when etherealised (helium-like) ethericities of carbone and the condensed waste of solar energy in gaseous form, so-called oxygen, become bound together and emulsify. This happens when the intermixture of diffuse substances takes place where a process of reduction occurs in lieu of oxidation.

Whether animating or de-animating life-forces come into being is dependent on the way these substances intermix. The life-giving impulse can only be stimulated, if etherealised carbone (helium-like) ethericities bind the waste products of solar energy that materialise in the form of gas, i.e. so-called oxygen. On the other hand, decomposive, life-removing forces will be stimulated if the process of interaction proceeds in the reverse order. That is to say, if the oxygen ethericities bind the maternal ethericities of carbone. When heated, oxygen becomes aggressive, whereas with cold it becomes passive.

<sup>7</sup> This patent is not to be confused with French patent No. 1.057.576, which relates to the double-spiral pipe described under 'Processes and Equipment for the Conveyance of Liquid, Gaseous or Aeriform Media', p. 107 of this book. It may thus apply to another patent, perhaps for a Repulsator or Repulsine. On the other hand, since both numbers are virtually the same except for one digit, it may also be a typographical error. — Ed.

<sup>8</sup> See Gastons Naessens' research into the effect of nitrogen on cancer. *The Persecution and Trial of Gastons Naessens* by Christopher Bird. — Ed.

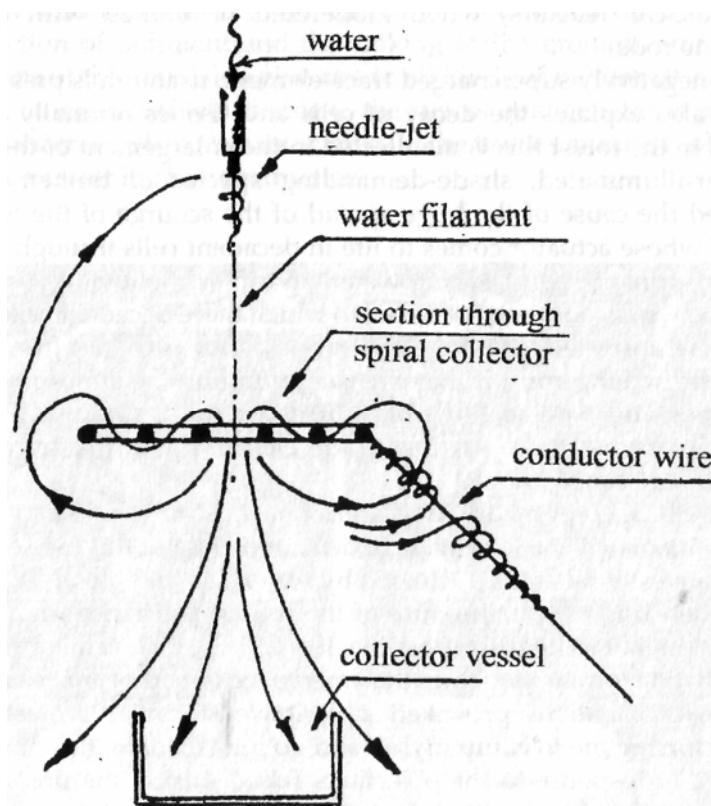

### Schematic Arrangement of a Single Needle-Jet with Spiral Charge Collector

Swedish Biotechnical Research Institute

Fig. 2: Spiral water jet experiment

Therefore, if water, sap or blood are over-illuminated, overwarmed or water is accelerated above its boundary velocity by pressure- and heat-intensifying techno-academic devices, such as steel ploughs, pressure turbines and pumps, pressure screws (propellers), Pelton wheels, etc., then the decomposive energies mentioned earlier come to life. These positively overcharged, invasive emanations are x-ray-like in nature and pierce every form of resistance. They penetrate right through to the negatively charged cell-nucleus and in the surrounding growth and life-forms cause the cell-nuclei to split. There

nuclear fission really begins in earnest. Such radiation generates immense heat (viz. nuclear reactors) when moderated or braked with pure carbone (graphite rods).

As a negatively supercharged trace-element, uranium is present in all cells, which also explains the decay of cells and tissues normally referred to as cancer. In the forest this is manifested in the enlargement of the annual rings in over-illuminated, shade-demanding species of timber. Thus is also revealed the cause of the huge spread of the scourge of the technical age - cancer, whose actuator comes to life in decadent cells through over-acidified food, in drinking and cooking water, and in air polluted by exhaust fumes. Here too we encounter tree-cancer, to which these decadent cells give rise and which is transferred to the tree by over-acidified nutrients. Iron molecules are particularly dangerous, if they are swept up into the atmosphere along with the fumes from iron-smelting blast-furnaces, for as catalysts they contribute to the interaction between low-grade elements and inaugurate conditions conducive to lung-cancer.

We are here concerned with bacteriophagous<sup>9</sup> threshold substances, which are first animated at a later stage of development. For this reason the view that this relates to viral entities released by water, sap and blood, is an error of the first order. It is the intermixture of the diffuse substances mentioned earlier that first makes fertilisation possible. It is the way in which impregnation takes place that determines whether the emergence of pathogens results or not.

These explanations provoked a veritable storm of protest in academic circles, forcing me to equip myself and go into action with somewhat heavier artillery. In response to the objections raised during the preliminary patent assessment, I then submitted the following supplementary explanation:

1. As inseparable trinities, the media of earth, water and air are the natural accumulators of biomagnetic and bioelectric dynagen concentrates. These are extremely sensitive to pressure and heat and may only be accelerated artificially in the original (primordial) way, i.e. planetarily, wherein cooling effects must predominate. Any abnormal increase in heat, no matter from what cause, triggers unnatural interactions between basic elements at the expense of the negatively surcharged, biomagnetic dynagen concentrates.
2. All over-illumination and overheating immediately provokes the release of decomposive energies; whether heating is the result of sunlight or

<sup>9</sup> Bacteriophagous: According to Collins English Dictionary a bacteriophage is 'a virus that is parasitic in a bacterium and multiplies within its host, which is destroyed when the new viruses are released.' Here the meaning of bacteriophagous has little to do with bacteria as such, but tries to express the notion of highly subtle, autonomous entities within entities endowed with the potential to imparl life- or death-decisive influences. Viktor Schauberger also explains them as threshold conformations or structures which are neither corpuscular, nor metaphysical in nature. — Ed.

processes of combustion is immaterial. In warmed up rivers and streams this is associated with losses in the carrying capacity and tractive force<sup>10</sup> (the deposition of sediment and the sinking of the groundwater table). The products of this emulsion give rise to all kinds of inflammation in all organisms, as a result of which, due to the lack of qualigen, the regressive course of cancer then becomes inevitable. In the tissues minute explosions occur, which result in their destruction.

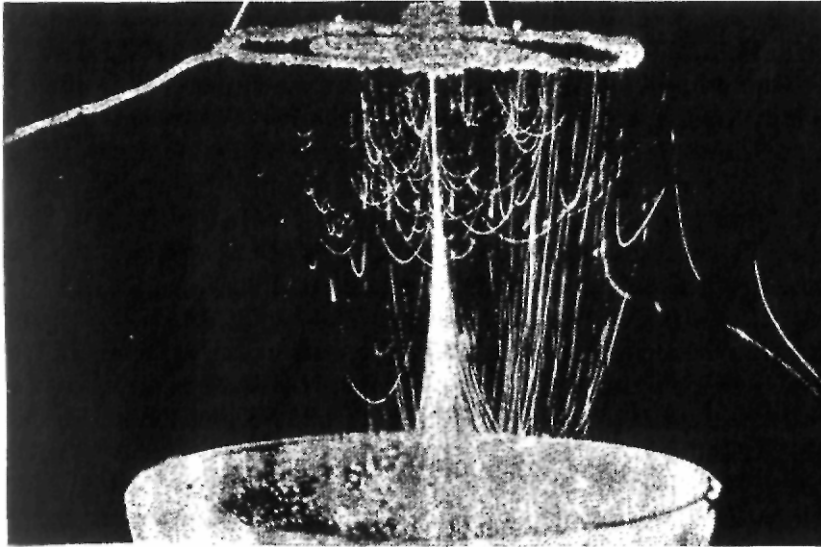

### Motion of Charged Water Particles around the Spiral Charge Collector

Photo from the Swedish Biotechnical Research Institute

Fig. 3

<sup>10</sup> Tractive force: This refers to the force described hydraulically as 'Shear force' — the force that acts to 'shear off' or to dredge and dislodge sediment. In German the term for shear force is 'Schubkraft', meaning 'to push, to shove' as well as 'to shear', whereas Viktor Schauberger uses the word 'Schleppkraft'. The verb 'schleppen' means to drag, draw or pull. Viktor Schauberger's choice of 'Schleppkraft' here is quite specific, since in his view the movement of sediment is due to the sucking action of fast flowing, dense cold water downstream, rather than to the mechanical impact of the water coming from upstream. In view of this subtle change in emphasis, in lieu of the hydraulically correct term 'shear force', the term 'tractive force' will be used. This dynamic is similar to the effect of wind on roofs, where a roof is blown off not by force from the windward side, but rather by the sucking effect of vortices created on the leeward side. -Ed.

Goethe called Nature's principal, formative essence the 'Eternally Female' and 'All-uplifting'. I have named it 'Qualigen'<sup>11</sup>. This can only come into being, if all medial masses (water, earth, air, etc.) are accelerated 'originally' - planetarily and predominantly centripetally by means of patented devices designed to create this form of motion. The design and the alloys used in the construction of these devices, which are continually being improved, are the exact opposites of those used in all areas of industry for the techno-academic acceleration of mass.

My allegations in this regard were construed as an affront to the honour and prestige of the Establishment and I was requested to provide written proof of these provocative assertions to the university professors I mentioned by name. This I also did and without exception they all had to capitulate. I could prove to them that as a result of techno-academic systems of motion - a predominantly centrifugal form of mass-movement - an atomic (electrolytic) excess pressure builds up in the structure of the basic elements, thereby producing an increase in temperature; in other words, a feverish condition. In contrast, an atomic (magnetic) low or negative pressure is generated through a form of planetary mass-motion in which centripetence predominates. This gives rise to a concentrative, negative pressure, which functions as a biological vacuum. It was discovered as early as 1908 by Professor Ernst Ferdinand Sauerbruch, who recognised that neither breathing nor expansion of the lungs would be possible if the biological vacuum were not to exist. He was declared a fool all the same and dismissed without notice when he told his superior, Professor Mikolitsch, the following:

"Were there no vacuum between the surface of the lungs and the pleura, no intake of breath, nor resistanceless expansion of the lungs would be possible. Everything would suffocate were this biological vacuity to be filled with normal, atmospheric pressure through any form of perforation."

Professor Sauerbruch was unaware that this vacuum comes into being through the planetary movement of the blood. Had he known, then medicine would have taken a completely different course.

I was further able to prove that because contemporary machines operate using centrifuge, resistances to motion with a reactive<sup>12</sup> function are

<sup>11</sup> Here the German word is 'Qualitatstoff', which literally means 'quality-matter, or substance'. With this Viktor Schaubergger intended to describe a higher, 4th or 5th dimensional magnitude of pure quality as a thing in itself and as the driving force in the raising of quality of whatever kind as a 'quality-producer' or 'quality-generating substance' or energy. The English expression term 'qualigen' used here, is a contraction of the two words 'quality' and 'generator'. — Ed.

<sup>12</sup> Active and reactive energies, temperatures, etc.: 'Active' essentially relates to the more physical dimension, to what is outwardly physical and perceptible, physically palpable, gravitationally affected or oriented, and life-negating, i.e. to energies that tend to curb, limit and brake life, evolution and development. 'Reactive' on the other hand relates to more metaphysical dimensions, to what is inwardly physically intangible, levitationally affected or oriented, and life-affirming, i.e. to energies that tend to foster, re-animate and accelerate life, evolution and higher development. - Ed.

generated, which increase by the square of the rotational velocity. In a certain sense this can be interpreted as the application of a brake by a violated Nature. With the use of my patented suction-screws (see figs. 4 & 5) on the other hand, performance and efficiency are increased in the same ratio through molecular processes wherein quality is built up, with the result that over-unity energies can be generated.

The product of this involuting motion, which always converges to a point while at the same time curling in upon itself, is biomagnetism. That it is also contingent on the presence of catalytic influences will not be further discussed here. As such, biomagnetism extends itself longitudinally and radiates its surplus energies vertically and, for example, draws the trout along in its wake. The trout can so regulate this upsuctional force with its gills that even its motionless stance and equally well-known mastery of gravity becomes understandable in the light of the above. The weight of physical masses only exists in the atmospheric living space. Above this the force of levitation prevails as inverted gravitation. Consequently, all pressure- and heat-intensifying motion must inevitably function all the more irrationally uneconomically and development-impedingly, the more it is accelerated and strengthened. To this end raw materials are squandered to such a degree that a growing dearth of them is unavoidable.

An exact chemical analysis revealed that over-acidified products of emulsion are created by present systems of mass-motion. In contrast, a 100% biomagnetically surcharged concentrate of qualigen is produced by planetary forms of motion. When infused into drinking water, it greedily binds excessive agglomerations of oxygen and purges the body. Cancerous tumours and growths become neutralised in the process and it is therefore the natural preventive of cancer and indeed the means of healing it. Science was never able to discover these things as all it knew was the opposite form of mass-motion that has caused all the havoc in the world. Growth is none other than biomagnetism has been solidified by the diffuse effects of light and heat. As a logical consequence, therefore, over-illuminated and / or overheated mountain springwaters must sink and their sources dry up.

An investigation carried out with a microscope has confirmed that crystalline structures form under technical forms of motion; that planetary motion produces morphous structures (see fig. 6). These are the typical indicator of high-grade interactions of diffuse substances, whose products of emulsion effortlessly overcome all physical weight and mental inertia. This heaviness will be increased, however, if any form of medial mass is made to move in the way that occurs today throughout the civilised world. In this case the ur-source of all life - water - will suffocate, its decomposition progressing all the more rapidly the more this hapless techno-academic system of motion increases in scope and intensity.

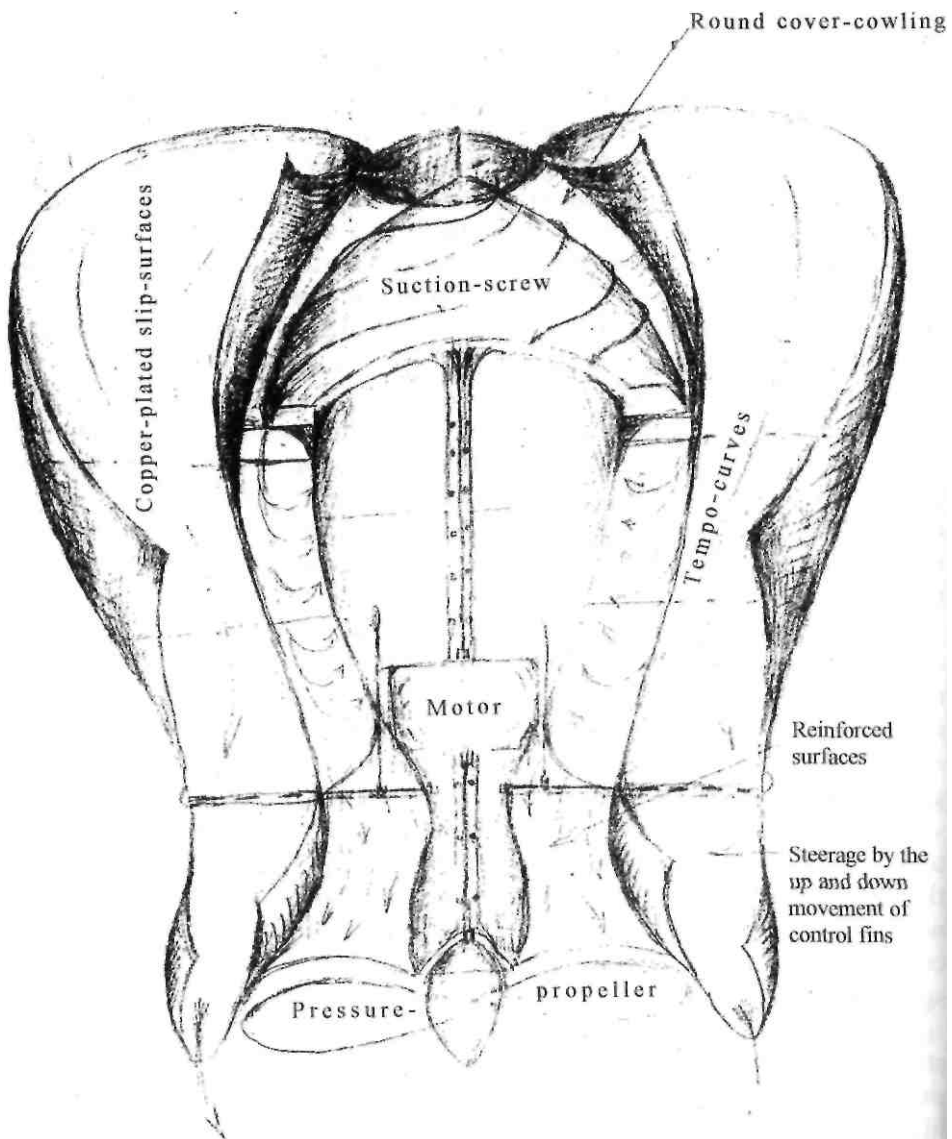

A Preliminary Sketch for the Suction- or Trout-Turbine

Fig. 4

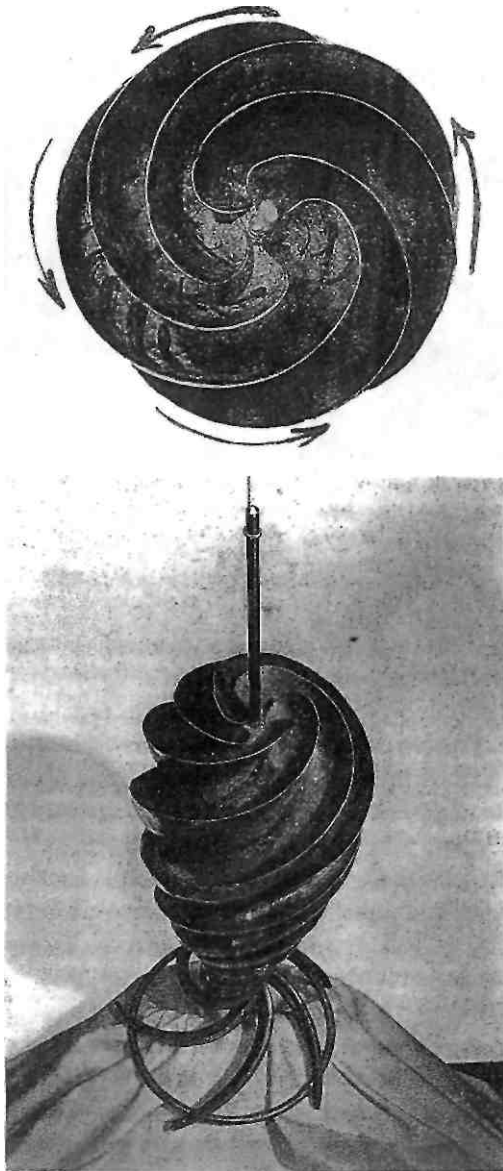

### The Suction-Turbine Rotor

The rotor of a suction-screw which narrows towards the base. Despite its operation using geological water-pressure, the flow-through material is not degraded, because here too centripetence prevails and the falling temperature gradient produced by it.

Fig. 5



## Viktor Schauberger's Microscope Evidence

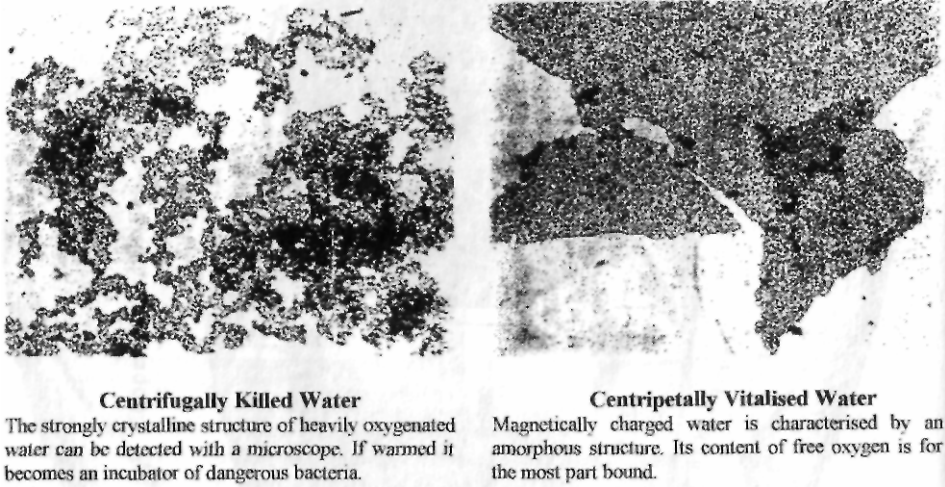

Fig. 6

Biomagnetism is quality. Its adversary is all forms of over-illumination, over-heating or centrifugally engineered increase in pressure. In this case bio-electricity is produced, which, in the form of an atomic force of excess pressure, possesses energies that function electrolytically and over-acidify decompose and kill all forms of life and growth. In the light of this, the deterioration of rivers and lakes becomes quite understandable. Since biomagnetism is quality, it follows that there is no constant conservation of energy in the presently accepted sense. There is likewise no equivalence between mass and energy and no insuperable force of gravity within the atmospheric envelope. All there is, is a rhythmical interplay between bipolar component forces, which ultimately inaugurates the final degeneration. In their interactive function as atomic pressural or suctional forces and through the biological vacuum thereby created, they also produce the best and cheapest driving force for machines.

As a result of all this the scales fell from the eyes of an ecclesiastical scholar, when I explained to him that the earthly remains of life (mineral and metallic trace-elements) were essential for the processes of reproduction, regeneration and upward evolution. Whereupon he responded, "My, but what a joke it would be, if we too had got hold of the wrong story! If the true rigmarole of the resurrection can only begin, when all the various cadavers are moved planetarily in the

womb of All-Mother Earth, a motion the techno-academic school-aristocrats have now turned inside out and into the opposite, then after we've gone every last remnant of culture must also disappear!"

"Indeed," I responded, "it would also be just as futile to sprinkle a dead body with a bucket of holy water. On the contrary, in a grave that is too warm, where the oxygen is aggressive, everything categorically goes to the Devil, and on Earth, due to the absence of qualigen, everything rots away alive."

Accordingly there are only two possibilities: Either this unfortunate form of mass-motion must be prohibited by law, or this thoroughly ruined and polluted work of creation must be blown sky high with the most efficient atomic bombs as soon as possible. - Amen.

## The Catalysts

Sherman, Texas, 28th August 1958, from Implosion Magazine, No. 123, pp 12-17.

When Robert Dormer's two representatives asked me to explain the essential nature of implosion, I told them that the correct choice of catalysts was one of the decisive preconditions for the success of a high-grade emulsion (the inner intermixture of bipolar basic elements). In this regard science defines a catalyst as a substance that alters the speed of a reaction by acceleration or deceleration. For the chemist catalysis signifies 'dissolution', whereas viewed bio-catalytically this is understood as the 'release' from inner urges and yearning. As this explanation is unscientific and therefore of little 'use', various examples will be examined in order to explain the concept of 'bio-catalysts', while not exactly scientifically, nevertheless naturalesquely.

It is known, for example, that for the liquefaction of brown coal (lignite) appropriate catalysts are required. Here there is no uniformity, because everything is bipolar and therefore it is necessary to make a clear distinction between positive and negative catalysts. The chemical reaction itself is of no interest biologically speaking, and the whole thing must be considered from a higher standpoint, otherwise it would be impossible, for example, to liquefy hard coal (anthracite), i.e. to transfer it to the next higher state of evolvment. This also applies to calcium (combusted marble) and other insoluble basic substances. That a falling temperature gradient is of decisive importance for biological processes of development, has already been emphasised elsewhere. Since science, which thinks too mechanistically, has also failed to grasp this, it would be unable to understand the naturalesque interpretation of the concept of 'reaction', which here is to be understood as a process of ur-genesis. Without this there would be no reproduction or further development, which is responsible for higher-grade emulsions, namely the inner fusion (marriage) of etherialised primary substances in the 4th spacial dimension. As long as the

precondition for development is not understood, the biological regeneration and qualitative improvement of contaminated and polluted drinking and domestic water will be impossible. This involves the retro-transformation of degenerate fresh water or undrinkable seawater into high-grade high-mountain springwater.

If such ennobled water is drunk, which accumulates normally insoluble trace-elements in a 'released' state and binds its oxygen content up to a maximum of 4%<sup>13</sup>, then the dissolution of normally insoluble sediment accretions takes place, enabling sclerosis, encrustation of the blood, sap and lymph vessels to be healed. The organisms thus treated regain their metabolic functions as well as their reproductive abilities. In this way senile men almost fully recover their virility. After extended consumption of regenerated drinking water, even people who wear glasses can use weaker ones, because the capillaries of the eye, which supply it with high quality nutrients, will be purged of deposits. Rheumatic disorders are cured within a short space of time, for through this general detoxification the joints move freely and painlessly again and are provided with a film of essential oils. Kidney and gall stones also dissolve after only a few weeks of drinking such healing water and are passed out in gravel-like form with the urine. All those suffering from cancer can get relief from their tearing pains almost immediately, because the almost oxygen-free water binds the excess oxygen in the blood<sup>14</sup>, thus eliminating dangerous hyperacidity. It is therefore not only possible to prevent cancer in this way, but even to cure this dreadful disease, if this all-healing water is drunk in good time. The healing of rheumy eyes with the aid of gold earrings also occurs in a similar way. Situated in the earlobes - the coolest location, they function biocatalytically and make any form of water secretion impossible. If one burns one's finger, then almost intuitively one grasps the earlobe, where the relatively strongest falling temperature gradient prevails, and an almost instantaneous relief from the burning sensation is felt. Catalysts in the form of the emanations from gold and silver not only function oligodynamically (they kill pathogenic bacteria), but also build up apathogenic bacteria, as happens in the vicinity of high springs. Having recognised this, a very open-minded doctor, the director of the old peoples' home at Lainz near Vienna, attempted to cure the sclerotic symptoms of seriously rheumatic W.W.II soldiers by administering the finest gold and silver dust. He only achieved a partial cure, however, because this can only be done with the infusion of precious metals in an organic state.

<sup>13</sup> This is slightly equivocal and can be interpreted in two ways: Either 4% of the 100% oxygen content is bound, or, up to 4% of the 100% oxygen content is bound, namely 96%. In view of what has been stated in "The Liquefaction of Coal by means of Cold Flows" on p. 95 of this book, it would appear that the latter interpretation is what is intended here. — Ed.

<sup>14</sup> The free oxygen radicals are bound. — Ed.

From experience the preparation of organic precious metals is only successful under the influence of a falling temperature gradient, because only thus can higher-grade emulsions take place; something that I have tried and tested myself. Dr Zuckerkandl, a forensic scientist who presently lives in Paris, analysed organic metals that I had ur-produced as long as 20 years ago. To his huge astonishment, he confirmed my assertion that metals of all kinds actually grow. This should be understood as the incarnation of ions, which for the first time correctly explains the generally accepted concept of 'growth'. This involves the solidification of stocks of bipolar dynagens under the influence of gentle and diffuse heat (viz. the highly metalliferous egg-shaped stones, for example, which emit a golden yellow glow even when rubbed together under water - the legendary Rhinegold and Gold of the Nibelungs. This has nothing to do with flints, which in any case do not spark under water.) Therefore it is also a mistake to believe that plants breathe in carbones and breathe out oxygen, which can be proven as follows: If the tips of enclosed stands of conifers are observed on very warm and windless days at about noon, then delicate transparent wraiths of mist can be seen, which waft upwards and disintegrate on exposure to excessive light and heat.<sup>15</sup> This is a sign that decentrating forms of emulsion are taking place. That is, the upwardly radiating carbones, which become passive (inactive) with strong light and heat, are being bound by the aggressive oxygen influence, which happens under a negative (rising) temperature gradient. In my own experience this also leads to the drying up of high-lying true springs, which can only rise under conditions where the oxygen is in a diffuse state. If these vapour formations appear above the tops of the trees, then it is certain to rain after about 4 hours. This prompted watchful foresters of old, who were close to Nature, to pack a raincloak in their rucksacks for the afternoon shift. If the opposite emulsive process takes place, i.e. if the downwardly radiating terrestrial energy, which becomes highly active under a positive (falling) temperature gradient, binds the excess oxygen, which becomes passive

<sup>15</sup> "Every mm<sup>3</sup> of water contains about 10,000 billion water molecules. Each contributes to the cooling effect of evaporation. Droplets rise in spiral paths towards the light (photophoresis)." Walter Schaubeger, *Implosion Magazine*, No. 5, p. 29.

"In mixed forests all the species of trees have different root systems. There are flat-rooted, heart-rooted and deep-rooted trees. The root zone is thus widely diversified and reaches a depth of about 5 metres. Such a forest cannot be torn apart by storms."

Aloys Kokaly, *Implosion Magazine* No. 54/55, p. 39.

"In the growing season, 1 hectare of forest evaporates about 50,000 litres of water, or 50 m<sup>3</sup> per day. In the process a quantity of heat will be extracted through evaporative cooling, which is sufficient to cool 3 million litres of water by 10°C. The sap in the stomata under the surface of the leaves is over-cooled, thereby becoming heavier and sinks down to the root-area, which it then cools, creating a zone of coolness, whereas the warmer and lighter sap rises in the sap ducts. (From an infinite number of the tiny stomata in the leaves and needles, which represent the finest imaginable sieve, the spiralling light ray draws out the minute particle of water and screws it up into the sky)"

Aloys Kokaly, *Implosion Magazine*, No. 62, p. 10. — Ed.

(inactive) in a diffuse state, then it will be exceptionally clear and cool above the tree-tops. This happens, because diamagnetically charged levitational forces come into being in a similar way as occurs in natural mixed forests, whose temperature in winter and summer constantly remains close to the anomaly zone of the interspersed water (+4°C - 39.2°F). This healing zone is sought out by sick and wounded animals, which go there to regain their health or to die a painless death. These sick beds, or surgical beds as experienced huntsmen called them, are also to be found in the water immediately below high-grade springs to which wounded game comes and to which the naturalistic huntsman hurries by the shortest route, where he finds the wounded creature dying in the healing water and puts it out of its agony with a coup-de-grace.

During early and late frosts experienced farmers protect their blossoming orchards by spraying water onto iron or steel plates through a system of paramagnetic<sup>16</sup> nozzles, which results in an immediate rise in temperature of about 6°C (10.8°F) in the crown zone. This water cannot mix with the differently charged surrounding air and remains unchanged even under the severest frost. This works incomparably better than artificial smoke generators (smudge pots), which are also known to protect the delicate blooms against freezing. If the above process is carried out with copper nozzles, then a conspicuous cooling occurs in the crown zone, which can be used to safeguard sensitive young shoots and protect them from scorching. This is especially necessary in the case of young light- and heat-sensitive seed-stock, which are often shielded from sunburn with leafy cuttings.

The simplest effect of catalytic opposites, i.e. fine-structured opposites with inner interuniting properties, or more properly having a 'marrying' tendency (ur-procreation), can best be observed in the generation of electric current, which is normally only successfully achieved with so-called dynamos incorporating rotors made of paramagnetic metal.

Conversely, if diamagnetic catalysts are used in dynamos constructed in exactly the opposite way (so-called Repulsators - see fig. 7 & figs. 24 ->26), then an upward flowing diamagnetism is produced, which viewed biologically is to be understood as 'levitation' (resurrective or upsuctional force), during which the follow-up pressure mentioned elsewhere plays a subordinate role. If the developmental process is initiated in reverse order, where the pressural components predominate, then super-strong gravitational forces are freed.

<sup>16</sup> List of paramagnetic and diamagnetic elements:

1. Apart from iron, nickel and cobalt, whose magnetic properties are already known, osmium and almost all iron compounds are paramagnetic metals.
2. Bismuth and antimony are particularly diamagnetic. Zinc, tin, lead, copper, silver and gold as well as glass and carbon disulphide and other non-conductors are strongly diamagnetic. Aloys Kokaly, *Implosion Magazine*, No. 45, p. 19. For further elaboration of the various forms of magnetism, see Chapter 2, endnote 23, p. 88, *The Fertile Earth*, Vol. III of the Ecotechnology series. - Ed.

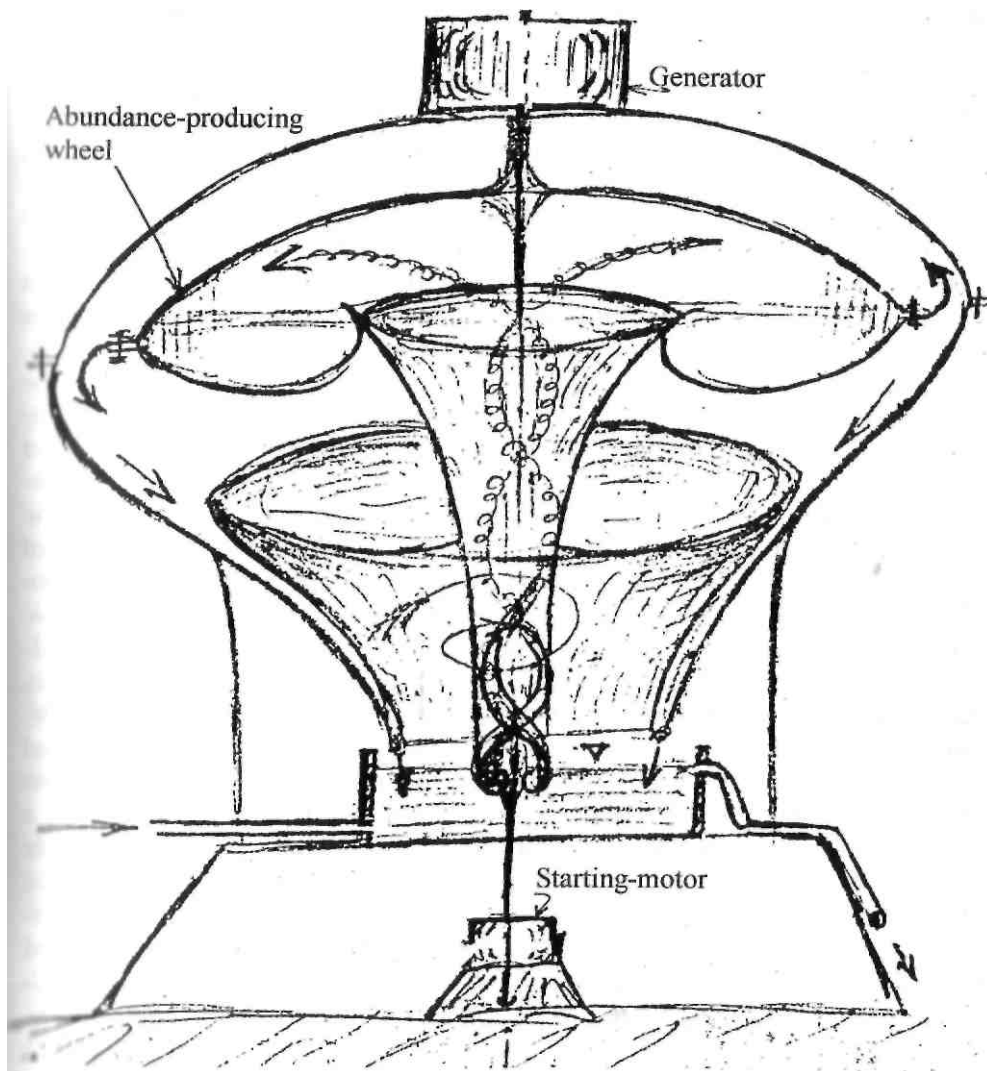

The Abundance-producing Wheel  
(Early concept sketch for the Repulsator)

Fig. 7

All today's expansion-explosion machines, pressure turbines, etc. generate decomposive energies that function reactively, and as a result and in conformity with natural law, regressive development is inevitable throughout the whole course of development.

Modern intuitionless science has regulated the eternal flow of evolution (*panta Rhei*) in the wrong way and thus failed to notice the possibility of generating *ur-forces*. Instead of additional products of emulsion possessing development-enhancing functions, it had to make do with development-disturbing reactive forces and resistances to motion that increase by the square of the reversed form of acceleration. According to an age-old maxim, "she half-pulled him down, he half-sank on her". In this play on words there lies a far deeper meaning. It would take too long here to enumerate all the catalysts with various functions, which as Goethe already recognised, form the 'connecting' (emulsifying) bond. They are ray-forms, upon whose function the development-disturbing rising temperature gradient and the development-fostering falling temperature gradient depend. Paramagnetic catalysts act decentrally diamagnetic catalysts concentrally. This fact alone pin-points the incorrect form of development, which ultimately results in the destruction of atoms. Wise Nature, on the other hand, proceeds by way of atomic transformation, which from a biological viewpoint is the exact opposite. Pressure and fire technology therefore produce retrogressive atomic energies, whereas implosion technology generates super-powerful, forward-thrusting atomic energies, i.e. an almost 100% formative and levitative force. And so the question arises, what actually is a catalyst? The answer is simple. It is a condenser that has been galvanically alloyed with oppositely-charged substances, which radiates predominantly negatively potentiated ray-forms into the naturalesquely (inwindingly) moved medium. This then activates a flowing diamagnetism, the formative and levitative force that soars upwards and sucks the generating device up in its wake, and which can be regulated by the rate of rotation. With this, the force was rediscovered that enables aircraft to overcome gravity effortlessly and stationary machines to be powered for virtually nothing. According to accounts from earlier times, the high priests of ancient cultures had a commanding knowledge of this power, which they cherished and guarded like life itself so as to be venerated as Gods for their skill.

By now it ought to be quite clear that the self-accelerating economic decline now taking place throughout the whole civilised world is the biological consequence of the pre-emptive regulation of the eternal flow of evolution, and that it is high time to rectify this grave error in motion against which humanity is lost. It is therefore imperative to reorganise all contemporary economic and industrial practices. The means best suited to achieving this is the spiral whorl-pipe, which like the double meander-membrane (*Repulsine*)

(see fig. 8 & figs. 30-33) operates in accordance with the principle of counter-flowing currents and generates diamagnetism. Under a falling temperature gradient, these devices accelerate the flow-through material almost without friction and with increasing suctional force, if catalytic binding energies are introduced into the flow-through material in order to produce those atomic energies, which exhibit precisely the opposite effects to those that are produced today in ignorance of the disastrous consequences. It was either an abysmal stupidity or the greatest crime of all time to exploit decomposive atomic energies for the build-up of a world-wide economy. How it is produced is still taught and learnt in all technical colleges of the civilised world and as a subject of higher education, is the basis for an unnatural and

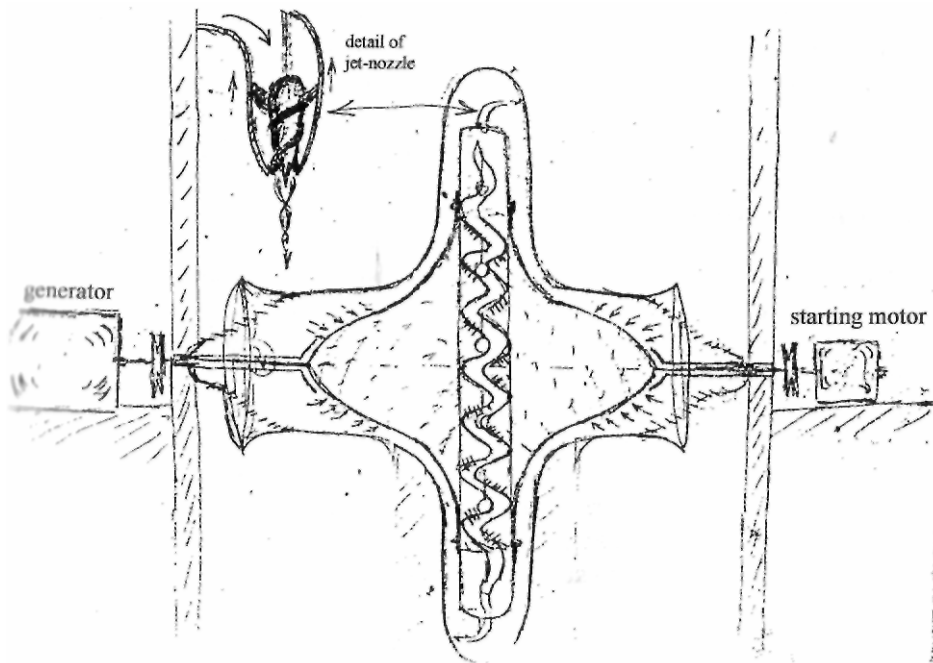

The Principle of the Abundance-producing Wheel  
 Exalting radial—>axial inwinding motion  
 (Early concept sketch for the Repulsine)



therefore false economic system. Further comment is now totally superfluous. In any case, it was an outsider, who rediscovered the secret of naturalesque mass-motion, and who thus perhaps rescued the whole of humanity from a ghastly end, namely to perish hopelessly from the putrefaction of water, sap and blood.

## Cadaverine Poison in Ray-Form (Ptomaine Radiation)

9th October 1949, from Implosion Magazine, No. 121, pp 3-12.

"What is the present outlook in the field of energy generation? One word suffices - catastrophic! Through over-illumination and overheating of the media of earth, water and air in Nature's household, a short circuit - 'cold fire' - and the development of cancer has been triggered off. With nuclear fission a conflagration was kindled, whose ashes and slag residues alone will extinguish all life. Thus a reporter stated recently, "For the time being this radiating thing is there and with it the attendant worries as to how we can protect ourselves against these lethal rays, which penetrate even the thickest lead shields." The sheer lunacy of using nuclear power for peaceful purposes will be just as short-lived as the subsequent remorse will be long." - Viktor Schauberger - Implosion Magazine No. 56, p.29-30.

### The pressure turbine

On the 16th of May 1913 Prof. Dr. Viktor Kaplan was able to inform the world's leading turbine manufacturers that he had succeeded in achieving rotational velocities and efficiencies with his newly designed impeller, which far exceeded existing norms.

This was confirmed by Prof. Budau at the test stand on the 22nd of June 1922. With this Kaplan saw himself at the culmination of years-long experimental endeavours, when suddenly an unexpected setback occurred, causing a severe nervous breakdown which crippled his ability to work.

When what had been achieved experimentally with the test model was implemented practically, mysterious cavitation phenomena appeared, which destroyed even steel turbine blades within a short space of time.

It was only after protracted and expensive experiments with alloys that these decompose phenomena could be sufficiently inhibited to enable the manufacture of this turbine system to begin. This was believed and is still so believed today, to be of such great service to industry and the economy, that a few companies licensed by Kaplan (because of the lucrative business opportunities) spared no material expense or intellectual effort in order to eliminate these decompose effects, which according to measurements were equivalent to peak pressures of about 32,000 atmospheres (atm).

In this way this dangerous centrifuge-machine was rescued from oblivion, which decomposes the geospheric and therefore negatively charged mother-water of the Earth (the true carrier of fructigens) in ever wider circles as the turbine's rate of rotation rises with increasing head of pressure.

The cause of this groundwater decomposition is the emission of analysing substances, namely cadaverine poison in ray-form (ptomaine radiation), which arises from liquefied stocks of fatty-matter when mechanically-induced centrifugal pressure and physically dissociative energies trigger lower-grade (expansive) temperatures, i.e. lower-grade cell vibrations, in molecular structures.

Here we are concerned with the consequences of a tragic error inasmuch as it is generally believed that the earthly remains of life, which relapse into the womb of the Earth, purposelessly decay into dust and ashes when the soul is supposedly separated from its former body after its physical vital functions have ceased.

In reality there are two mutually opposed fermentation processes (forms of inner motion) that determine what is to be created from these allotropic (polymorphic) fat-concentrates entombed in the Earth along with the cadaver. Decomposive and retrogressive energies - the above ptomaine radiation - are active here, which are generated when the reversed fermentation process that produces positively charged acids is triggered by thermal influences which intensify internal (rupturing) pressures. This is further exacerbated by the disintegrative effect of mechanics, which bio-logic-ally speaking gives rise to reactivated centrifugal motion. It thus becomes clear that in Nature there are neither equivalencies, nor any constant conservation of energy or matter, but only differentiations, which mutually potentiate one another. Robert Mayer, Isaac Newton and others devoid of intuition - therefore nature-alienated lawmakers - have seriously erred (exact proof of this exists) inasmuch as in an eternally changing Nature there are actually no rigid laws, no domas or absolutes, but only a rhythmical interplay of energies, which determine the fate of all existence.<sup>17</sup> This is because the products of this interplay, already in an atomic state, have an in-built capacity to react, and are therefore products of bio-logical development.

Just a slight positively surcharged motive or stimulative influence is enough to discharge the blood of the Earth, the extremely pressure-sensitive accumulator of the true life-forces in statu nascendi, which it accumulates in order to transform them into reactivated formative (levitative) or disintegrative (retrogressive) energies.

Under natural conditions, this very water, like plant juices or higher-grade bloods, is raised by indirect means to the highest mountain peaks through its

<sup>17</sup> In relation to Newton's discovery of the laws of gravity, Viktor Schauberger comments: "I think it would have been much better if Newton had contemplated how the apple got up there in the first place!" Implosion Magazine, No. 35, p 16. — Ed.

inner levitative forces. However, if it is moved and churned up by high-speed pressure-turbines, hydraulic river regulations or cascade-like torrent confinements, then lower-grade forms of charge and potential give rise to positively supercharged effluxes of energy, which radiate in all directions (this can be proven exactly), pierce through and discharge all resistances, and through internal rupture, loosen the water's structure, thus corrupting the character and the quality of this dynagen concentration (see fig. 6).

As also happens with rapidly moving tractor-drawn iron (steel) ploughs<sup>18</sup>, this gives rise to electrolytic dissociative effects and detonating-gas-like eruptions (so-called earth-rumbles) over a wide area, which further enlarge the structures mechanically that have already been pre-loosened up through their inner excitation. That is to say, the above forms of inner motion and excitation mutually amplify one another by way of such chain-reactions, whose periodicity rises by the square of the rotational velocity. On the one hand the products decisive for development are ur-created, i.e. the buoyant atomic forces (levitation) that effortlessly overcome all physical weight, and on the other, those retrogressive energies, which mortify all life through the enlargement of the tissue-structure. Therefore either the cadaverine poison in ray-form or the life-elixir in an atomic state is created, which overcomes all disease.

This explains why, for example, the resistance to motion increases by the square of the unnatural (centrifugal) rotational velocity in all technical, hydraulic and dynamic pressure- and heat-increasing machines. This, however, does not occur if medial masses (earth, water & air) are accelerated 'originally' in the manner of the natural motion of the Earth's mass (see fig. 9), namely centripetally along the longitudinal axis. Such motion, which builds up everything indirectly and maintains the whole Earth in delicate equilibrium, can be copied in a manner true to Nature with the aid of very specially constructed and alloyed devices.

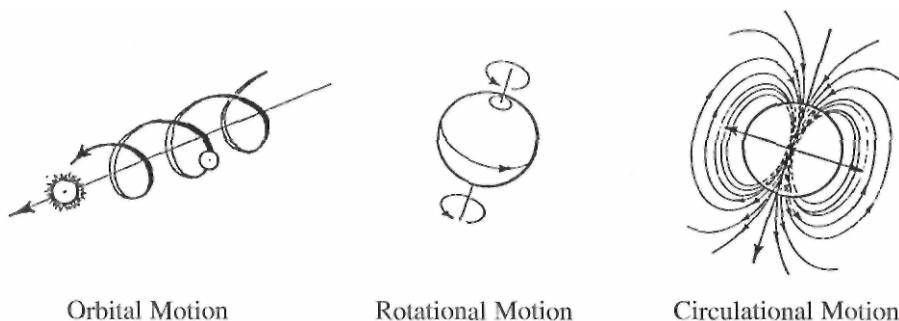

Fig. 9: The natural tripartite motion of the Earth

<sup>18</sup> See descriptions of the effect of steel ploughs in *The fertile Earth*, Vol. III of the Ecotechnology series.  
— Ed.

In this case the relatively highest grade forms of atomic energy can be developed, which move everything 'originally', thereby imbuing all things with life.

Undoubtedly known to the high-priests of ancient cultures, these concentrates of noble matter (ethericities) are responsible for the legendary near-absolute abundance of food and the freedom of movement associated with it. Incidentally, these concentrates were also ultimately responsible for the disaster of Atlantis, referred to as the Flood by a circumspect Church, which was the result of the careless control of these elemental levitative energies. In this respect the Church was quite right, because the negatively potentiated mother-water (amniotic fluid), the physically first-born, will be precipitated out by these formative and levitative energies (there is exact proof of this). It is in this ennobled carrier-substance, however, that the latent higher-grade atomic energies reside, which make naturally ordained locomotion possible. These energies, however, can be transformed into the most developmentally harmful forms of atomic energy if, for example, a cyclotron-like centrifugating device is employed as the supposedly correct means for producing energy. Hitherto it has not been known that vitamins, the concentrates of noble matter (perfectly developed fat-formations fermented under the exclusion of light and heat, which are known to solidify at death) can be degraded through inferior (expansively-acting) influences of heat and light and are gradually transformed into the atomic ptomaine radiation mentioned at the beginning. Only recently has so-called vacuum-distillation been applied to obtaining high-grade fat-concentrates from essential oils. For this, however, only atmospheric-gas-rarefying devices, air-suction or air-pressure pumps are used, which can never emulate the processes that wise Nature employs for specifically densifying these highest-grade concentrates of ennobled matter. This is the 'Organic' vacuum. Created by a centripetence-machine, it densities noble matter through the co-active influences of higher-grade motion and contractile stimuli. That is to say, the moved (accelerated) mass approaches the temperatureless and feverless anomaly state (+4°C - +39.2°F), which is only possible through mass-acceleration on the longitudinal axis. Nor can the resistance to motion mentioned earlier evolve during this process for the simple reason that this 'original' system of mass motion and acceleration, the dissociative, structure-loosening, positive temperature influences are missing, which would otherwise induce an increase in dangerous wall-pressures. It should be noted that it is entirely immaterial whether a molecular interaction between basic elements is initiated by a physical or metaphysical motion-excitation combination. In the same way that social revolutions arise from psychological stimuli, so too can a beneficial fever and thus the healing of a supposedly incurable disease be provoked by a strong inner stimulus, or conversely, sudden death through a so-called stroke, caused by an abrupt alteration of the inner interaction between basic substances.

The all-decomposing cadaverine poison in ray-form mentioned at the beginning is produced indirectly and therefore ur-produced by every pressure- and heat-intensifying machine of the relatively highest power. For this reason the blood-of-the-Earth-centrifugating Kaplan turbine is one of the first machines that must be eliminated as fast as possible. If this is done, it will still be possible at the eleventh hour to arrest an economic and cultural decline with all its perilous political repercussions throughout the civilised world, which will have been caused by the generation of lower-grade atomic energies.

### The suction turbine

The suction-turbine (see figs. 30-33) is the most suitable device for countering this event, for it can ur-produce the most noble formative and levitative energies from water, which function at an atomic level. It builds up the Earth's amniotic fluid, which all today's technical, hydraulic and chemodynamic machines, conveyances and agricultural implements, etc. decompose; in particular the high-speed, blood-of-the-Earth-centrifugating Kaplan turbines and Pelton wheels.

Under the term 'suction turbine' is to be envisaged an inverted pressure turbine. It is an apparatus with which water can be densified mechanically and physically, therefore 'specifically', at the same time. By being moved in this way, the anomaly state so vital to life, the temperatureless and feverless condition of health, can be attained regardless of any positive temperature influences.

This 'original' cooling of the flowing water takes place because the medium can be accelerated without being retarded by the direct action of wall-pressures. In this case, therefore, the resistance to motion that normally increases by the square of the increase in velocity - the reactive effect of all centrifugal pressure - cannot develop.

Specially constructed blade-systems are here involved, which swirl the draining water-masses about their own centre of rotation. Under these conditions neither positive, nor negative temperatures can arise. Therefore the water accelerated in this way approaches the anomaly point of  $+4^{\circ}\text{C}$  ( $+39.2^{\circ}\text{F}$ ). It is thus temperatureless and feverless, i.e. it becomes healthy and capable of reproduction and further development.

This form of water movement is therefore the one ur-generated by the blood of the Earth, the liquid that pressure-turbines decompose. This explains why water becomes increasingly scarce where pressure-turbines are operating. Not only do they trigger an x-ray-like emission of radiation (inner heat and light), which destroys the structure and quality of the most vital cell-tissue, but in addition they rob the draining old-water of any ability to reproduce and further develop = to increase and ennoble itself, due to the decomposition of its

vital subtle-matter concentrates. This is the reason for the deterioration and dying out of water, without which there would be no growth, no life and no restoration of living standards on this Earth, for diseased water = inferior quality life. In regard to the systems of motion outlined briefly above, this results when, via the indirect route of the structure enlargement and character deterioration mentioned earlier, the seed of decay is ur-fertilised in the ur-cell of life by the irradiating cadaverine poison, which arises from the allotropic fat-concentrates exposed to pressure-intensifying forms of water movement.

Precisely the opposite is achieved when water and its vital constituents are accelerated in a suction-intensifying and invigorating type of turbine constructed with special alloys, which densifies the water mechanically and physically, therefore 'specifically'. In other words, a concentrative, structure-reducing, and character-improving synthesising current evolves, which radiates in all directions and also ur-fertilises the substance that the emissions from pressure-turbines decomposes.

The outbirth of this ur-fertilisation is the physically first-born. It is the geospherically negatively supercharged amniotic fluid of the Earth in which, as is the case with all physical forms of procreation, the co-originating spirit is bound, which is also ur-created through the above higher-grade processes of motion and excitation. In the opposite case the most dangerous dynagen concentrate results, which only recently, free of any constraint, is being generated with the aid of an ingeniously designed centrifuge - the cyclotron - for the supposed purposes of national defence.

Produced in suction-turbines, the negatively potentiated ur-product of the cycloidally-moving Earth is therefore the 'original' resurrected entity, which in accordance with Nature's laws must be braked by a corpuscular carrier-substance. Unless this happens it will accelerate out of control and drag everything along with it. (viz. the cataclysm of Atlantis in which the supposed Deluge was triggered by the precipitating out of ur-water at great heights - a process that can be copied experimentally.)

For this reason the suction-turbine must also be braked by heavy operating loads, otherwise it would also over-accelerate and levitate. In this case, in lieu of the familiar resistances to motion, additional rotation and levitational forces evolve through the upsurging bio-magnetic rotary synthesising current.

In both cases we are therefore concerned with supplementary ur-forces having opposite functions, which inaugurate either a progressive economic decline or the opposite. This explains why even the ancient Greeks rejected technology. Derived from the ancient Greek word 'technao', its literal translation means 'self-deceit' or 'self-cheating'. The Greeks preferred the natural labour of slaves in order to spare their evolutionally older descendants from later perils.

In terms of the actual design, the gill-system of the stationary trout should be adopted as a model for the construction and fabrication of the suction-

turbine. This fish, which is known to remain motionless in torrential flows, flees upstream like lightning when danger threatens and in the spawning season floats upwards in the centre of the falling water-masses, which gyrate in cycloid-spiral-space-curves. Possessed of the requisite aids to enhance the potential of the 'original' dynagens, the trout cannot only overcome its own weight, but also the specifically heavy water-masses flowing against it.

In conclusion it is necessary to address in more detail the question: Whence do these gigantic levitational forces actually come? Taking a very large-scale example from Nature, these are the forces that maintain the whole Earth in a fragile state of equilibrium, because they also move in cycloid-spiral-space-curves like every falling filament of water.

The raw material for these atomic developmental products are the earthly remains of former life. Above all, it is the concentrates of fatty-matter which, regardless of any external positive temperature influences, solidify after death. These are subjected to fermentation processes similar to those taking place in the stocks of fatty-matter in plant juices from which, depending on the type of motion and excitation, various acids evolve that give further rise to essential and energetic concentrates. This only happens if no vessels are used, wherein annihilating fire robs these concentrates of their allotropic (polymorphic) trace-elements, namely their concentrates of essential oils, which in such high-grade fermentation processes act like yeasts.

It thus follows that all today's technical, hydraulic and chemo-dynamic machines, conveyances, agricultural implements (ploughs, harrows, disc-tillers, cultivators), dynamos, turbines, propellers, pumps, etc. are developmentally harmful, for apart from their pressure-intensifying shape, they are almost entirely constructed with materials unsuited to Nature's processes. Their use triggers off lower-grade vibrations in molecular structures.

To the catalogue of bio-logical, therefore reactivated, errors in motion and excitation committed by modern nature-alienated science, which has inaugurated the 'other' reaction and which is responsible for the decay and death of everything in existence, the following are to be included:

- The supposedly advantageous 'light-induced' growth in monocultivated plantation forest, which is none other than the incipient proliferation of cancer, triggered by the influences of excessive light and heat inaugurated by modern forestry science;<sup>19</sup>
- The pressure-intensifying cascading of contemporary systems of torrent confinement;
- The loss of tractive force and carrying capacity, and the associated problem of sediment, which has become insoluble;

<sup>19</sup>See references in *The Fertile Earth*, Vol. III of the Ecotechnology series. — Ed.

- The silting up and dislocation of the heavy water-masses, which must breach their banks, because the formation and build-up of the reflux (upstream flowing) bio-magnetic products of noble matter that ur-fertilise the water, have been arrested through elimination of the form of motion that produces it. This is how the hitherto inexplicable steadiness in draining water-masses down a variable gradient was lost.<sup>20</sup>

In this fashion all growth was also interrupted due to the shape and material of unnaturally constructed and alloyed ploughs, etc., which resulted in the triggering of reversed reactions in the pressure-sensitive, negatively potentiated and therefore cool fertile nutrient substratum.

Particularly serious mistakes were made through the spreading of blast-furnace slag (so-called artificial fertilisers), whose intensified combustion once again robs the soil of its essential energy concentrates, the congealed oily sweetness, which the de-energised and finely pulverised slag then drags to itself from the surrounding negatively potentiated groundwater. Artificial fertilisers therefore remove the blood of the Earth's formative substances, which it must supply to the plants indirectly for the purposes of further ennoblement. In this way too, those levitational factors were eliminated which triable the specifically heavy groundwater to maintain its precarious suspension on steep slopes. From this it can be seen how dangerous are the influences of fire and the lower-grade, expansively and explosively functioning temperatures that arise from fire-affected masses.

This vaporising heat-form, which gradually leads to the desiccation of the soil, is the best prerequisite for the development of parasitic bacteria, whose appearance should be taken as a warning sign that serious errors in motion and excitation have been made. If these errors can be rectified, then the parasites disappear automatically, because in a cool (fresh) soil, only apathogenic (health-enhancing) bacteria can survive.

It is therefore ridiculous, for example, to try to treat polluted water with chlorine, or to eliminate all noxious life-forms with poisonous gases, which would otherwise disappear automatically by changing the motive and stimulative influences. In the opposite case, the evil will only be reinforced, for through the influence of the above poisons even what is still healthy will become diseased.

Assuming that from what has been stated the two principal causes of the progressive economic decline and its political repercussions are now clear, all that now remains to be done is to demonstrate the origins and causes of this decline in quality to the competent authorities.

In more specific terms, this unwelcome state of affairs involves the disturbance of the interchange of substances at a molecular level. In other words,

<sup>20</sup> See references in *The Water Wizard*, Vol. I of the Ecotechnology series. — Ed.



the alteration of the above fermentation process at its most fundamental phase. To make this even clearer: Allotropic oxygen conformations are liberated through pressure- and heat-intensifying dynamic effects or volume-enlarging thermal influences, because the fat-concentrates with opposite polarity become inactive and are maintained in a passive state under such influences. This results in the inner fission (dissociation) of the previously internally interconnected and highly evolved, therefore extremely pressure- and heat-sensitive trace-elements, which like yeasts initiate the process of raw-material transformation - the fermentation process described above.

It thus becomes comprehensible that all motion gives rise to inner molecular excitation, and conversely, that strong excitation causes a reversal in the molecular vibrations (the inner form of motion).

This explains why, for example, the hitherto incurable can suddenly be healed and the hitherto healthy can become incurably ill (e.g. suffer a stroke). It also explains the hitherto inexplicable effect of the water long known to the ancients as healing, or more correctly all-healing water, which 'specifically' densifies to the highest degree. Such water carries within it the relatively highest-grade products of synthesis derived from the above higher-grade dissociation and therefore is able to reprogramme the molecular fermentation process and thus specifically to heal the condition of disease caused by the opposite primary metabolic processes.

In the management of today's forestry, agriculture, water and energy resources, lower-grade interactions between basic substances are triggered exclusively and without exception. That is to say, molecular disturbances are caused through the influences of fire and expansively acting temperatures. These disturbances immediately intensify into chain reactions, thereby weakening the interaction between basic substances in the whole organism or actually reverse it. Thus, in accordance with Nature's inner laws, the disruptions to development will become all the more severe, the more modern science, which produces the reversed motive and stimulative influences, achieves its phoney successes. In lieu of the 'original' pressure-less and heat-less motion of the Earth's masses, it has invented and applied the reversed methods of motion and excitation.

Those who understand what has been written here will have to agree that we will inevitably become the hopeless and hapless victims of the scourge of the technical machine age, if we do not eliminate the errors in motion and excitation made thus far as quickly as possible, which ur-produce cadaverine poison in ray-form the 'specific' means of decomposition, as the end-product.

## 2.

# New Forms of Temperature

"The inner climate stamps each individual with its character. Every life-form has its own individual anomaly point of health, which makes the orderly reproduction of the species possible. This also explains why the world of parasites increases with fever."

Viktor Schauberger, Implosion Magazine, No. 71, p. 12.

## A Brief Description of My Discovery

Leonstein, 1945 (Schauberger Archives).

**A**rising from an exhaustive and in-depth observation of Nature, my discovery consists in the fact that all life and growth is shaped and fashioned through vibration and movement. This naturalesque form of motion I finally discovered after decades of research and countless series of experiments. It is the creative curving form of motion found in Nature that I have come to describe as 'cycloid-space-curve-motion', which in more common language is perhaps more easily understandable as a 'life-curve', 'curve of Nature' or even as a 'bio-curve'.

Furthermore, I have also devoted considerable time and effort to translating these forms of motion and dynamic shapes, faithfully copied from Nature, into terms of mechanics. In this I succeeded and it provided me with the basis for my bio-technology.

Through the naturalesque movement of liquid or gaseous substances (e.g. water and air) the following arise in Nature as well as in my apparatuses (which are neither difficult nor expensive to mass-produce):

- (a) Two different forms of temperature, which I shall refer to as  $T_1$  and  $T_2$ . Conditioned by these temperatures and also closely associated with them, there also arise:

(b) Two different types of flow, which we shall describe as  $F_1$  and  $F_2$ .

Through these hitherto unknown forms of temperature and motion the substance in question (i.e. water or air) is decomposed, transformed and built up. In this way, through appropriate regulation, elemental energies are freed. Suctional and pressural forces come into being, which in my apparatuses evolve along a common developmental axis and represent an entirely new means of motion and propulsion.

To contemporary technology, physics and chemistry the following are so far unknown:

1. The form of motion used by Nature herself (i.e. the cycloid-space-curve as the creative form-originating motion);
2. The temperature-form  $T_2$ ;
3. The flow-forms  $F_1$  and  $F_2$  and the phenomena of elemental transformation resulting from them.

In Nature the purpose of temperature-form  $T_1$ , which is associated with flow-form  $F_1$ , is to transform the condensed (allotropic) inner elements of organisms into aethero-energetic<sup>1</sup> animating and kinetic energies. These  $T_1$  temperature-forms gives rise to falling and concentrating heat and exhibits rising and expanding cold effects.  $T_2$  triggers reduction processes and fosters apathogens. If  $T_1$  predominates, then an increase in raw materials and the qualitative improvement of all products of growth result.

Temperature-form  $T_2$ , which is related to flow-form  $F_2$ , is generally known to contemporary technology, physics and chemistry. Its purpose in Nature is to precipitate out what has been decomposed, but not decayed, through  $F_2$  flow-forms, or what is unsuitable for the purposes of the next higher form of development.

$T_2$  temperature-forms exhibit rising and expanding forms of heat and falling (decadent) and condensing (concentrating) forms of cold.  $T_2$  furthers bacterial life. If  $T_2$  temperatures predominate, then a reduction in raw materials coupled with a simultaneous thriving parasitic activity results, the effect of which again reinforces the removal for reprocessing of everything unsuitable for higher purposes.

These phenomena, still unknown to conventional science, I have already exploited practically for the extraction and transport of otherwise untransportable timber in log-flumes at Neuberg in Steyrling and 14 other installations around Europe.<sup>2</sup>

<sup>1</sup> aethero-energetic: This essentially refers to energies belonging to the 4th and 5th dimensions of being. — Ed.

<sup>2</sup> See references to log flumes on pp. 82 & 107 of The Water Wizard, Vol I of the Ecotechnology series. - Ed.

Today I had the opportunity of presenting a feasibility study for a large project of this kind in Upper Austria to a government agency, and in this way and through its realisation, I hope to be able to make a valuable contribution to reconstruction (after W.W.II) and the Austrian economy itself, and at the same time furnish new proof of the correctness of my discoveries.

## Excerpt from Bio-Technology: Active & Reactive Temperatures

Leonstein, Easter 1946, Schauberger Archives.

Decades-long observations of Nature, innumerable trials and series of experiments led to the discovery that two fundamentally different temperature-groups exist in Nature, namely:

- (A) a group with life-creating functions, and
- (B) a group with life-destroying functions.

All forms of heat that initiate rising and expanding effects, and all forms of cold which inaugurate falling and concentrating effects belong to group B and are therefore development-impeding (growth-destroying). All forms of heat that give rise to falling and concentrating effects and all forms of cold that exhibit rising and expanding functions belong to group A and are thus development-promoting. Both expressions of temperament - and all forms of temperature can be viewed as such - serve for the build-up of tension, charge and potential. On the one hand these give rise to life-affirming dynagen-currents, which come into being when naturally fermented fatty-matter, which the chemist calls 'carbons' (sweet matter), consumes (binds) the oxygenes<sup>3</sup> in an allotropic (condensed) state. On the other hand, life-negating dynagen currents form if the oxygenic elements, which become free, unipolar and aggressive under the influence of usual forms of heat (B-group temperatures), consume (bind) the sweet-matter concentrates. Under such influence the latter become passive and increasingly dense as they inwardly contract. In solid, liquid and gaseous inorganic bodies these life-negating currents act in the same way as poisons do in living organisms, and provoke processes of decomposition, decay or combustion; in a word, they destroy everything ripe for development. In the form of a formative and upwardly impelling dynagen flow, the digestive product of the former metabolic process has development-furthering (growth-promoting) effects.

<sup>3</sup> Oxygenes: In similar fashion to the previous explanation and interpretation of 'carbones', this relates to all normal forms of oxygen as well as to its more metaphysical provenances. — Ed

In Nature both temperature groups are active. Group A provides for the progressive build-up of what is suitable for higher development. Group B is responsible for the precipitating out, breaking down and disassembly of everything unfit for such purposes. This has to be removed and as a life-form must be annihilated, or expressed more correctly, reduced to the relatively lowest developmental state, prior to attempting a renewed ascent under entirely different influences. This temperature group also becomes active when any given life-form has fulfilled the purpose of its existence, its duty to multiply itself physically or further develop itself. Withering away through decrepitude, and as an over-ripe product of raw material, it is then made available for the build-up of qualigen with the aid of A-group temperatures. However, if for any reason B-group temperatures become active in the deceased substance, it will be putrefied, combusted or otherwise destroyed.

Temperature group A is entirely unknown in scientific circles today and is also missing in our conceptual and linguistic vocabulary. All that is known therefore are the so-called processes of oxidation, combustion or decomposition; the so-called reduction process being understood only in part. And this only to the extent to which it is responsible for the separation of both stocks of primary substances, namely the dissociation of the allotropic carbon and oxygens present in deceased organic or inorganic structures.

All analyses of whatever kind are followed by a synthesising process, i.e. the manifestation of what has been evolved to a higher level. This is initiated by A-group temperatures out of which the formative, reproductive, upwardly evolving and qualitatively improving synthesising current arises.

Either this important, or more correctly, vitally important process and the products of development arising from it are wholly unknown, or the possibility has been suppressed, which, with the aid of that which 'radiates' formatively, would enable the enlightening life-flame to be supplied with qualigen. Here we are concerned with the end-product of a life-affirming (reactive) metabolic process, the most highly evolved fatty-matter already in a metaphysical state, without which no increase in intellectual activity (ability) of any kind would be possible.

In other words, either it is believed in such circles that progress as an individual ceases with the cessation of vital physical functions, or there is a definite interest in ensuring that, by inhibiting the production of qualigen by deliberately eliminating A-group temperatures, the dull-brained can never die out.

The fact of the matter is that all forms of heat applied and exploited by science today, however and wherever they occur, engender rising and expanding effects. Similarly, all the forms of cold it utilises have falling and concentrating (mortally solidifying) functions, which lead to degrading, life-destroying expressions of temperament. These wise Nature employs to eliminate everything unfit for further development as well as for purposes of

decomposition, for evacuation of excrement, or for initiating combustion processes that almost completely annihilate almost everything.

This means, no more and no less, that retrogressive development will occur everywhere the influence of science is active. Therefore, for lack of the supply of qualigen, mental abilities will constantly deteriorate in step with the progressive rise in the quantity of living flesh. People will become imbecilic, vegetative and the lower orders of life will atrophy and little by little will cease to exist, because the relatively highest energy-concentrate, the 'upwardly radiating', is missing, which manifests and declares itself as 'Life'.

Apart from this, it is an indisputable and demonstrable fact that B-group temperatures are about 96% more expensive to produce than the reactive A-group temperatures responsible for formation and uplift, for which natural development-facilitating devices and associated systems of motion are required. The necessity to work will therefore become progressively less, and food and other necessities will increase quantitatively and qualitatively as formative and levitative power strengthens.

The same applies to all natural means of producing light and power (viz. the natural increase in the Sun's heat, when the distance from the Sun increases in summer and the developmental path of its energies elongates, or according to the findings of Pickard's research, it gets all the colder and darker, the closer this supposedly fiery orb is approached.)

When the Earth approaches the Sun in winter the intensity of light increases, because in this case the resisting power of the Earth's almost hermetically sealed pores (nozzles) becomes greater. If this natural reciprocity is copied naturalesquely, then the production of power, light, heat and cold will be virtually free. On the other hand, germinating- and growth-energies will continuously and progressively rise to about an average of 30% per annum, which roughly corresponds to the normal increase in the human population.

The devices for practically implementing the generation of the bio-magnetic formative and levitative current with the aid of reactive temperatures (natural-esque expressions of temperament) have now been invented and in principle can be mass-produced.

## The Life-Current in Air & Water

Leonstein, May 1946, (Schauberger Archives).

"Equivalence signifies uniformity and thus immobility."

Viktor Schauburger, Implosion Magazine, No. 113, p. 23.

It is a well-known fact that what we call the temperature of a body is the result of the motion of its molecules. According to the speed of such motion,

higher or lower temperatures are produced. As the motion slows, the temperature drops until ultimately, with the cessation of all molecular motion, absolute zero is reached at  $-273.15^{\circ}\text{C}$  ( $-459.67^{\circ}\text{F}$ ).

Cold is therefore just as much the result of motion as is heat, and de facto is merely a lower level of heat. So much for the scientific point of view.

Entirely unknown to contemporary science, however, is that apart from this familiar form of temperature, there are also 'higher' forms of heat and cold, which are equally attributable to molecular motion. These 'higher' temperature-forms are to be differentiated from those referred to at the beginning in that the 'usual' forms of heat have a rising and expanding function and their associated cold-forms have a falling and concentrating function.

The 'higher' heat-forms are characterised by the fact that they possess falling and concentrating functions, and their associated cold, or refreshing forms have rising and expanding properties. So much for the general appreciation of this bio-technical finding, which is essentially founded on 'higher' physics, or biophysics.

This 'higher' practically implementable metaphysics has nothing in common with today's science. We are therefore here concerned with real 'knowledge' and in no way with the commonly held concept of 'science'.

The formulation of all terminology concerning this 'higher' knowledge is uncommonly difficult for the simple reason that today's science has commandeered all the relevant terminology, and thus in the German vocabulary there is a lack of suitable words with which to formulate these new concepts in a meaningful way.<sup>4</sup> For this reason the only way to approach things is by way of circumlocution so that they can be half-way understood by scientists.

A true understanding is only possible after appropriate observable demonstrations, whereupon all the rigid theorems, principles and dogmas of today will then be rendered untenable and quickly collapse upon themselves. Moreover, all present laws, regardless of whether they concern the laws of energy conservation, gravitation or so-called heat-equivalence, will likewise be invalidated. To make it quite clear at the outset, what is here involved is something entirely new, which is why any proper assessment by scientists would be impossible. For this reason the Austrian government was requested to dispense with the expert opinion of specialists. All that is required is practical proof for which certain prerequisites are necessary, such as the one requested in the memorandum of the 15th of March 1946.<sup>5</sup>

Uncanny experiences in a high alpine reserve almost untouched by human hand and a perhaps extraordinary gift for observation of Nature led to the discovery that a mysterious current lies hidden in the media of air

<sup>4</sup> This also applies to the English language. — Ed.

<sup>5</sup> This relates to the provision of premises for research and development mentioned later in this article. — Ed.

and water, which is freed when these aqueous or gaseous bodies are moved naturalesquely.

In every respect, experiments with this formative and levitative (synthesising) current produced surprising results. Thus, for example, 2,000,000 volts per drop of water, which were measurable, visible and palpable, and therefore incontrovertible, could be freed with appropriate charge-releasing devices. With 50 pairs of needle-jets about 200 million volts can be produced for virtually nothing, for which today's science requires giant machines. Even then it can only produce an exceptionally disintegrative (analysing) current, which has life-negating properties. This is to be differentiated from the formative and levitative, therefore life-affirming, functions of the synthesizing current mentioned elsewhere.

A few examples of applications should explain in general terms the nature of this novelty, still wholly unknown to contemporary science.

If this current is conducted into vacuum tubes, then they emit a strongly pulsating blood-red glow horizontally along the elongated transverse axis and a dazzling, motionless, colourless and temperatureless radiance vertically up the elongated longitudinal axis, which fills the whole space.

If the horizontally emitted current is first accumulated in a Leyden jar and conducted thence into petrol, then a tongue of flame is produced and the higher the accumulated charge, the longer the flame.

If this current is conducted through strongly insulated resistances, then cool, juvenile water, free of other ingredients is produced, which exhibits an uncommonly high dissolving capacity and cohesive power. Conducted into a hinged lever, which hangs down, this current stands it upright. It also causes pendulums to gyrate in peculiar looping, twisting movements.

If this current is introduced into ordinary water, then the water becomes cool, dense and specifically heavy and its ion-count increases many thousand-fold.

If such water is drunk, then every kind of pain ceases almost immediately. After prolonged consumption of such water both mental and sexual potency increases in a truly striking fashion. Even the impotent will regain their potency. Kidney stones, gallstones and accretions of similar nature are dissolved and expelled in the form of grains or mucous. Rheumatic pains disappear completely after a few weeks. Venereal and malarial bacteria are eliminated and passed out of the body in bloodstained urine. In short, under the supervision of doctors, no affliction has yet been found which has been able to offer any resistance to this life-current. Even malignant cases of cancer improved quite remarkably. These experiments were discontinued, because the secret state police intervened owing to rising indignation amongst the medical fraternity. Later I received a valuable offer from the English banker and financier, Sir



Victor Sassoon, which was made in the presence of Dr. Ing. Haertel Wien, director of the State Water Resources department. This I declined, because it required my moving to America or England and I had no desire to leave my homeland. For the same reason I also declined an offer from the Russians. Other offers from France, Turkey and Italy were similarly rejected.

If specifically heavy high-quality water is atomised and the resultant water-vapour is compressed by a descending piston with a simultaneous infusion of atmospheric oxygen, then this aqueous mixture of air is instantaneously transformed into increased and highly potentiated stocks of new air. The expansive pressure produced in this way corresponds to the power of about 2,000 atmospheres per litre of water.

If ordinary air is bio-centrifugated above the speed of sound in very specially contoured and suitably alloyed development-facilitating devices, for which an auxiliary mechanical force is required in the order of 0.08 kW per cubic metre of moved air, then the torque-producing current (synthesising current) mentioned above arises, which also accelerates the device that generates it. This further accelerates the intake of air, which again intensifies the strength of the current, resulting in an even higher rate of rotation, which provokes yet a further increase in the torque-producing current, and so on. Ultimately a powerful and highly potent vacuum is created in front of the generating device, while at the same time the expansive pressure described above exerts a squeezing, wedging pressure along its teardrop-like body (see figs. 22<sup>6</sup> & 38). These suctional and pressural forces, which evolve along a common developmental axis in the form of a fully developed dynagen gradient can overcome any weight or form of anchorage.

What is here involved are the colossal carrying and tractive forces that maintain the whole Earth in an unstable floating state and cause it to rotate in peculiar spiral space-curves (cycloid-space-curve-motion). They are the same forces that maintain the delicate equilibrium of a trout in fast-flowing water and enable everything that crawls and flies on this dung-heap - Earth - to overcome their own physical weight.

In opposition to this dualistic formative, levitative and life-affirming force, however, there is a counterforce, which comes into being in a similar manner. It is also a biotechnically producible current, but functions in a life-negating way and can thus be described as the 'death-current', since, with the exception of developmentally harmful bacterial life-forms, it slowly but surely destroys all life. It breaks down and decomposes every organism so that under very specific pre-conditions and with the aid of a very peculiar movement it can ur-generate new life or death forces of increased and intensified power from the product.

<sup>6</sup> In regard to fig. 22, while the diagrams depict a submarine, theoretically the same process should also apply to a similarly shaped aircraft. — Ed.

Practically and factually we are thus presented with the unveiling of the seven enshrouding veils of Sai<sup>7</sup>. We stand before the secret of the genesis of all life and its unfoldment, which viewed objectively is none other than the perfection of all that is raw material. It is the eternal process of self-renewal out of which are born the forces of growth and formation, as well as those of renewed decomposition and reversion, which appear in the form of synthesising or analysing currents, depending on whether the medium of air or water is moved naturalesquely in specially constructed and alloyed development-facilitating devices, or unnaturally in unsuitable ones.

As absolute opposites these two forces, which promote either progressive or regressive development, arise from different sources; the destructive forces evolving from the temperature-forms that today's science exploits to operate its various types of machine. The formative and levitative forces on the other hand stem from the 'higher' temperature-forms which, as stated earlier, are unknown to contemporary science.

Conventional science has so far only become acquainted with the forms of heat that exhibit fatiguing effects, which however are those heat-forms through which the resistance to motion increases by the square of the velocity. This occurs for the simple reason that they are precisely the forms of temperature that kill off all dynamism and vitality and which, after a suitable development, are transformed into the condensing (falling and concentrating) cold-forms in order to conduct the thing in question back onto or into the Earth, where under the exclusion of light and heat it is prepared for a renewed attempt to rise.

The actual source of life - the 'higher' temperature-forms from which the life-affirming, formative and uplifting levitation-current evolves, is an absolute novelty to today's science.

Whether such a science consciously or unconsciously exploited precisely the opposite means to achieve a desired build-up of culture - the build-up

<sup>7</sup> To give a greater understanding of events at Sai's, that ancient Egyptian city in the Nile delta, The Secret Doctrine by H P Blavatsky relates: "...And how little Herodotus could tell is confessed by himself when speaking of a mysterious tomb of an Initiate at Sai's, in the sacred precinct of Minerva. There, he says 'behind the chapel is the tomb of One, whose name I consider it impious to divulge... In the enclosure there are large obelisks and there is a lake near, surrounded with a stone wall in a circle. In this lake they perform, by night, that person's adventures, which they call mysteries. It is well to know that no secret was so well-preserved and so sacred with the ancients as that of their cycles and computations. From the Egyptians down to the Jews it was held as the highest sin to divulge anything pertaining to the correct measure of time. It was for divulging the secrets of the Gods, that Tantalus was plunged into the infernal regions; the keepers of the sacred Sybilline Books were threatened with the penalty for revealing a word of them.' The Secret Doctrine, Vol II, page 396. While not directly related to the Seven Veils of Sai's, the following quotation from The Secret Doctrine, Vol. III, p.132, may afford further insight into what was hidden behind them. "An impenetrable veil of secrecy was thrown over the Occult and Religious Mysteries, after the submersion of the last remnant of the Atlantean Race, some 12,000 years ago, lest they should be shared by the unworthy, and so desecrated. Of these Sciences several have now become exoteric — such as astronomy, for instance, in its purely mathematical and physical aspect." Ed.

of quality matter, which is what concerns us here and which has been inhibited by these development-impeding temperature-forms, cannot be entered into here.

The fact of the matter, however, is that through these totally perverse procedures and all manner of unnatural activities, everything we are experiencing today that is difficult, disgraceful and degrading of human dignity had inevitably to happen. Deductively thinking logicians have therefore overlooked the causes of the supposed effects, out of which, depending on whether the form of motion is natural or unnatural, the respective ancillary forces that either affirm life or negate it come into being. In this regard the life-denying forces increase, reproduce and advance themselves in exactly the same way as their counterparts, which promote the naturally ordained course of further development through increase and qualitative improvement. This would be impossible, however, were it not for the temperature-forms responsible for expelling what is inferior and for purging, purifying and detoxifying organisms. It is out of these temperature-forms that the decomposing, analysing cavitation current arises, which today's science uses in the widest variety of ways and without exception for a supposed build-up of culture. Clearly the misfortunes we shall have to reap will be all the greater, the more widespread and intensive the activity of a science that makes use of these lower-grade temperature-forms.

The first person, who had unconsciously to grapple with this disastrous development, was Galilei, whose discovery that the Earth itself moved, caused an immense uproar in secular and religious scientific circles. Galilei was forced to recant, although he recanted his recantation shortly before his death. This he did at a moment when he could no longer be harmed by those, who like past dictators used similar means to torture those whose opinion differed from theirs, believing they could re-instil faith through the agonies of torture. His opponents, however, who were just as dangerous as they were ruthless, had practically no alternative but to acknowledge this new fact.

Curiously enough, since then apparently no scientifically trained individual has bothered about the causes of the mysterious motion of this dung-heap Earth, and the purpose of its exceptional form of motion. This disinterest, however, was only feigned. In reality, since Galilei's discovery, people were very much on their guard in order to avert the immeasurable repercussions resulting from the revelation of: 'Why' does the Earth ceaselessly rotate about her own peculiar system of axes in an unstable state of equilibrium in so-called free space in very particular looping movements in defiance of the laws of gravity?

This 'why' has been clarified by various of Nature's phenomena. Amongst others, the stationary trout that stands motionless in torrential alpine streams and flees upstream like lightning whenever danger threatens. Or spawning

trout, which, floating upwards, are able to surmount freely overfalling waterfalls several metres high, if particularly hollowed out flow-guiding stones cause the falling water to flow in 'cycloid-spiral-space-curves', the form of motion that arises and can be observed above every bunghole through which water is able to free-fall. This how the water-inwinding suctional forces evolve and the reactive forces acting in the opposite direction come into being in the axis of the suction-vortex. It is the latter forces that are at issue here. Today's science, which measures and weighs everything exactly, overlooked them, because the 'producer of measure and weight' can neither be measured with a yardstick, nor weighed with decimal scales.

In a word, after decades-long observations, trials and series of experiments, I succeeded in getting to the bottom of this mysterious double-game of Nature's and in becoming aware of the unspeakable ferocity and purest mother-love that are united behind her two eternally concealed faces. I came to recognise the scales of fate of all life upon which every action is scrupulously weighed after death and that whatever is no longer fit for the next higher evolutive progression is once more ruthlessly eliminated, it being of too inferior a quality for its metaphysical transformation into exalted entities in the form of the above formative and levitative current. It has to return to greater or lesser depths within the Earth to interact with those vibratory influences in such a way that out of these basic substances new formative and levitative energies evolve for a renewed attempt to rise. It is these revitalised substances, whose higher forms of cooling essences possess expanding and upwardly impelling functions, which make this resurrection possible. Falling and concentrating light- and heat-forms then subsequently ensure the intermediate solidification of 'what is destined to vegetate', namely the actual physical form of growth in which the counter-energies also reside, which initiate the further interactions that enable this intermediate assembly of raw materials to grow, to reproduce and further evolve itself. Now comes a brief description of Nature's principal formative substance - metaphysical fatty-matter<sup>8</sup> - about which a thick book could be written. As a reactive or 'higher' temperature-form this comes into being with the aid of the Earth's 'cycloid-space-curve-motion' under the exclusion of light and ordinary heat in the cool germinating zone, the boundary zone between the negatively potentiated geo-atmosphere and the positively potentiated external atmosphere. This then develops as a potential that propagates horizontally in a wavi-linear movement.

<sup>8</sup> Fatty matter. In its association with what Viktor Schaubergger calls 'sweet matter', a creative, formative substance, this relates to compounds principally containing carbon C and hydrogen H (carbohydrates - CH) and all the elements under the collective term 'carbone' or 'mother-substances'. In this regard, despite its general 'neutrality' as a carrier substance (like a woman with child), H is more inclined to the feminine than the masculine. — Ed.

The raw materials out of which this fine matter arises under very specific preconditions, consist of the naturalesquely interred earthly remnants of former life. On no account are they senselessly and purposelessly reduced to dust and ashes, but once again, under particular preconditions, they develop into the 'peculiar' axis in the form of the formative and levitative current mentioned earlier. This spiritualising and uplifting current, which inwinds, upwardly impels and whirls around like a tornado, is partially condensed by the above heat-forms and can be readily measured and generated in any quantity and quality almost without cost. By means of this formative and levitative current all growth can be increased and qualitatively improved almost at will, and any weight can be lifted or moved indirectly at any desired speed rotationally and / or vertically with a power that increases by the square.

The source of this formative and levitative marvel is the 'higher' temperature-form that evolves through the previously described form of motion, which is produced in very specially contoured and alloyed development-facilitating ur-forms (extreme egg-shapes).

Naturally, this ur-powerfully-active principal formative substance is barely perceptible in water or air, because the naturalesque motion of the Earth has already transmuted it into a metaphysically potentiated state, where in a semi-free and semi-bound condition it characterises the 'goodness' and 'intrinsic quality' of the aqueous or gaseous medium.

Therefore if the media of water or air are moved naturalesquely (and the trick is how to do this) then the bipolar gases are initially transformed into aetheric and ultimately into energetic stocks of subtle matter. These are then bound in the self-evolving juvenile media (air and water) and what has been increased in this way is rendered homogenous and specifically densified. That is to say, they intensify the carrying capacity and tractive force to such a degree that in such waters material with a higher specific weight than the transporting medium, even ore with a specific weight of 1.9, readily floats down the centre of the axis, where the strongest suctional force acts downstream and the strongest reactive force acts upstream in the form of a dynagen gradient, but which, however, has no effect on raw material structures to the extent that these do not involve life-forms.

This also explains why the very moment that watercourses were hydraulically<sup>9</sup> regulated, i.e. when the natural system of flow was ruined, the calamity concerning the transport of sediment began.<sup>10</sup> The riverbanks were attacked, the riverbed silted up and the water ejected itself from its dislocated course with elemental ur-force in order to regain its naturalesque form of motion, through which that something is also propagated and deployed to which

<sup>9</sup> Hydraulically: The use of the term here relates specifically to conventional hydraulics, — Ed.

<sup>10</sup> See Viktor Schauberg's writings on river engineering in *The Water Wizard*, Vol. I of the Ecotechnology series. — Ed.

everything that lives on this manure-heap owes its independent movement, the 'original form of motion', and its own power to reproduce and further develop itself.

This naturalesque form of motion will now be once more reinstated in those places where there are inaccessible stands of precious timber, which are apparently untransportable with oxen, horse-teams, tractors, cable or forest railways, etc. and, as occurred at Neuberg in Steyrling, will be floated to its destination as circumstances demand with about a 90% saving in transport costs compared to the best transport systems presently available. Therefore at a time when, according to radio and press reports about 800 million people, i.e. about 1/3rd of the world's present population, are threatened with starvation, those people can be saved, whose only assets are those valuable timbers spared by modern forestry, because they were deemed irrecoverable, and who for this reason will be repaid in gold by nations with a high exchange rate, or in what is of far greater value today - food. For today whatever still stands in accessible forests - as every timber expert knows - is worth nothing, or precious little. Such products of forestry science are in any case unsuitable for export.

After this brief pointer as to how these gigantic formative and levitative forces can be made use of in the national economy, it should also be mentioned that these 'original' tractive and transportive forces can be applied to the silent, odourless, smokeless, toxic-emission-free propulsion of all types of machine, all forms of conveyance on land, on water and in the air at any desired speed and at negligible cost, for in such machines, instead of resistance, the power increases by the square of the velocity. Now devoid of foundations, the crowning law of fire-spitting technology will therefore collapse upon itself.

It would take too long here to describe the necessary preconditions through which it is possible to build up the energy-sources (the 'higher' temperature-forms) out of which the formative and levitative current - characterised in the title as the 'life-creating current' - comes into being.

A small error in motion therefore suffices to provoke a general susceptibility to cancer in what has created everything we can see around us or are otherwise aware of.

It is really not immaterial whether motion must first be active in the production of a temperature, which on its part triggers a reactive increase in motion, or whether a temperature induced by physical, thermal or chemical means affects physical movement by way of the molecular motion. The matter first becomes complex, however, when the different temperature-forms mentioned earlier are included in the equation, wherein it is also necessary in regard to the types of motion, to differentiate between those that produce the 'higher' or 'lower' temperature-forms.

The former invigorate, the latter enervate.

The development of high-grade products of potentiation is only possible via an exceptionally long course of development - and what is decisive here - only if the mechanical motive impulse takes place first, which then automatically gives rise to the reactive increase in power upon which the normal course of further development is founded.

However, as is the case with all today's machines, if the physical, thermal or chemical starting impulse happens first, then the opposite reactive course of further development results. It thus becomes clear that with an increasing rate of rotation the resistance to motion increases by the square of the enforced acceleration in the interchange of substances (metabolism).

The crowning law of today's technology is therefore no natural law, but the biological consequence of a tragic error of contemporary science. For if the naturalesque metabolic process is initiated through equally naturalesque impulses (*il primo movere*), then as the velocity increases owing to the additional input from the inwinding rotary current, the power increases by the square. The outcome of this developmental process is an almost cost-free, development-promoting mechanical power - the evolving water (*viz.* the atomised water vapour).

In the opposite case, annihilating fire and its cohorts, including toxic gases, are created, which in association with the debilitating temperature-forms from which rigor mortis develops, foster the proliferation of bacteria.

It thus follows that all attempts to combat the source of disease of whatever kind, are senseless and futile as long as the formative metabolic processes are not controlled causatively at their root-level. This also explains why pains disappear and the most serious diseases improve markedly when water is drunk in which formative and levitative substances have been bound and which further evolve at the expense of the developmentally harmful elements in the organism that consumes such water. As a result the organism automatically regains its capacities, *i.e.* it becomes physically and mentally potent - and therefore healthy.

Fundamentally, therefore, we are dealing with two metabolic processes entirely different in nature and function, both of which are necessary, for without any purging and purifying process no more highly evolved forms could be built up.

These two metabolic processes, which in every organism interact reciprocally, are:

- (a) the process of oxidation, and
- (b) the process of reduction,

which, while known to today's chemist, are initiated unnaturally, therefore in the wrong way, and carried out with the use of ordinary temperature-forms.

The product of the oxidising process is an analysing current.

The product of the reducing process is a synthesising current.

In the first case a form of molecular motion is inaugurated, which results in the principal primary formative substance being bound, consumed and digested by the countervailing stocks of oxygen.

This process is caused by the liberation of this dangerous retrogressive substance, which has become unipolar and aggressive through a pre-active physical, thermal or chemical starting impulse, whereas the principal formative substance, the naturalesquely fermented fatty-matter, or so-called carbon (carbone), becomes passive and inactive under this influence.

However, if the mechanical starting impulse is activated first, which must be produced in appropriately contoured development-facilitating devices, then higher cold-forms arise through which the fatty-matter (carbone or sweet matter), which reacts to centrifugence,<sup>11</sup> becomes free, unipolar and highly active. In this situation the oxygen, which becomes passive under this influence, is consumed (bound), providing it has been dosed (dispersed) mechanically and made palatable (thinned out), (viz. the swaying and fluttering branches of plants).

Every developmental or redevelopmental process therefore has its characteristic source, which gives rise to one or the other activity (function).

This involves two temperature groups:

(A) the formative, life-affirming (incremental), and  
(B) the disintegrative, life-negating (decremental).

To group A belong all falling and concentrating heat-forms and all cold-forms, which initiate rising and expanding phenomena. To group B belong all rising and expanding heat-forms and all cold-forms having falling and concentrating effects. This latter temperature-form is applied by today's science universally, and hence it strives in vain to achieve the build-up of any form of culture (i.e. a naturalesque course of further development). On the contrary, it must reap economic reversals, which will become all the more palpable, the more widespread and intensive this activity becomes.

In Nature both temperature groups are active in every healthy organism.

This is necessary because the formative and uplifting levitational essences evolve from the higher temperature group A and the purging dissociative

<sup>11</sup> This seems to conflict with statements made elsewhere, which attribute intensified carbone activity to centripetence (outside—>inward motion), and intensified oxygen activity to centrifugence (inside->outward motion). In actual fact for each of the two substances there are two opposite 'reactions' involving centripetence and centrifugence. Oxygen 'reacts' to centrifugence by becoming aggressive and 'reacts' to centripetence by becoming passive. Conversely carbone 'reacts' to centrifugence by becoming passive and 'reacts' to centripetence by becoming highly active, as is also affirmed on the following page. — Ed.



forces from the lower temperature group B, which enforce the gravitation of all that cannot be uplifted. This duality therefore involves a rhythm within a rhythm - a sort of four-stroke motor, in which upward, downward, inward and outward impulses can rhythmically take place on a common developmental axis. A perpetual state of turmoil is constantly created in an epicentre of commotion, leading to continuous fission and fusion (separation and combination), whereby what matters is which metabolic process predominates. In other words, in this primordial battle between the ur-feminine and the ur-masculine, whether the re-destructive or the re-creative is victorious. The one that triumphs is the one that is able to drag its opponent into the middle of this gigantic wrestling match, there to encircle, bind, consume and digest it.

The very specific molecular motion mentioned in the opening paragraph is what is decisive here. More particularly, a mechanically induced outside-inwardly directed impulsive force is required, through which, aided by supplementary influences, Nature's principal formative substance - naturalesquely fermented, etherised fatty-matter (carbones or sweet-matter) - becomes free unipolar and highly active and is able to overpower its opponent, which becomes passive under these influences.

Here we are concerned above all with a conformity with a natural inner law of reciprocity today entirely unknown to science. That is to say, with very particular types of motion in specially formed and alloyed development-facilitating devices, the preconditions described in the preceding paragraph are satisfied, and because of this the 'Eternally Feminine', as Goethe called this creative essence, can press its counterpart (oxygen) into the centrepoint of this battle and conquer it (see fig. 10).



Fig. 10: The Mill of God

The product of this event is the mysterious upcurrent, the naturalesquely ordained resurrection marvel. Springing forth from 'higher' temperatures, it rationally and truthfully explains the increase of what is corpuscular and its qualitative improvement - in a word, the transmutation and perfection of all that is raw material - the process of self-renewal, or to put it briefly, evolution and all growth, its coming into being and passing away.

However, if a physical, thermal or chemical starting impulse is first active, which influences the molecular motion in such a way that the oxygen becomes free, unipolar and aggressive due to the resurgence of positive, group B temperatures, then having been forced into the centre of this combat, the principal formative matter will become passive and will be bound, consumed and digested. The product of this event is the developmentally harmful cavitation current - a variety of the so-called electric current - which as an exceptionally analysing current not only pits and corrodes steel turbine blades, but also decomposes and dissociates the blood of the Earth - water.

In short, it robs everything and anything of its remaining formative and levitative energies in order to mortify the thing itself and to dispatch what has deviated from its ordained path back into this eternally fermenting manure heap - Earth. There, thanks to her special motion and other prerequisites, the total transformation of what has sunk down ensues.

Blood formation or blood decomposition - synthesising or analysing current - vitalisation or devitalisation - health in mind and body or disease, death and economic disaster, all these are decreed by what in the opening paragraph science calls molecular motion whilst having no knowledge of the differences in the forms of motion, which not only determine existence or non-existence, but also all economic progress or decline.

There is insufficient space here to explain the nature of biomagnetic and bio-electric currents or their origin and purpose in more detail. They always come into being and operate simultaneously, because everything is bipolar, i.e. in every man the feminine also exists, and in every woman the masculine. Here too it is merely a question of which type of molecular motion took place first, thus giving precedence to processes of oxidation or reduction. All it takes therefore is a small starting impulse to determine the fate of all living things and whether they are dispatched on a downward or upward path.

Contemporary science is founded on far too low a level of knowledge. The dying forests, the wasting fields and meadows, the polluted waters and the mind- and body-crippling industries are frightening warning signs of a total failure to appreciate the true workings of Nature. Through false pictures of the world, world-views and the ways of working arising from them, science unconsciously or consciously arrested the build-up of quality matter, thus committing the greatest stupidity or the greatest crime; the crime against the spiritual germinating force. It inhibited the transformation of matter into

aetheric and energetic structures and entities; the very thing that even Christ placed at the cardinal point of his world-shaking teachings. This transformation is only possible if very precisely constructed and alloyed calyx<sup>12</sup>- or cup-shaped vessels are moved in the same way that priests have demonstrated to us before the altar for about 2000 years, although they themselves were perhaps unaware of the true significance of this swinging, cruciform motion.

No words suffice to castigate what nature-alienated individuals have perpetrated on their unsuspecting fellow human beings through ignorance or their desire to rule. There is only one thing to do: To point out the developments that we are experiencing today, namely the biological consequences of the disruption of Nature's water-balance through totally unnatural work practices. As a result, all those things, which that something that accompanies us faithfully and unselfishly from the cradle to the grave, requires for its coming into being and its original movement, will now have to travel the road to ruin.

And this ur-blood of the Earth has thus far only been viewed as a chemically inert substance and the provisions for its journey - the diverse forms of sediment - merely deemed to be impurities!!

This may truly appear to be the monstrous invention of an unsound mind to those who have no inkling what colossal energies are contained in a tiny drop of water, which are either bound or freed according to the type of motion. It may also seem just as utopian when it is stated that with the aid of these elemental ur-forces secreted in the medium of water and in the air (or the condensed Breath of God), the entire production of power, heat, cold and light can be reduced in cost by slightly more than 90% and that with this formative synthesising current all growth can be increased by about 30% per annum and qualitatively improved.

Today's forest, land, water and energy resources management and all branches of contemporary science - whatever the specialist discipline - are tragic mistakes, whose terrible consequences will only become apparent when the irrefutable truth has been grasped through practical demonstrations; when people see and understand what is created when any thing - above all air and water - is moved unnaturally and therefore wrongly. Through this absurd form of motion precisely that temperature-form is produced which gives rise to the developmentally harmful cavitation current that wise Nature uses to remove everything from the path of evolution, which for one reason or another is unfit for the growth and formation of the relatively highest quality.

And precisely this tremendous source of power has hitherto been utilised for a supposed build-up of culture!! This continuously destructive principle is taught in every school, so that all humanity is being led into an almost

<sup>12</sup> Calyx = the sepals of a flower collectively forming the outer floral envelope, protective of the bud. — Ed.

escape-less dead-end. Rigid laws and dogmas were contrived which simply do not exist in Nature, where constant change is sovereign.

The immutable law of reciprocity, without which there can be no natural-esque motion, nor anything brought to life, was overlooked, disregarded or deliberately suppressed, "Nulla poena sine lege" (no punishment without law).

For Nature to punish those individuals responsible for the dreadful fate of millions upon millions of human beings was impossible. She therefore had no other alternative but to condemn the whole of humanity, the most dangerous of Nature's trouble-makers, to death by starvation.

Eight hundred million people, i.e. about one third of those alive today [1946], will be mercilessly condemned to starve, if at the final hour it is not possible to produce the practical examples necessary to open the eyes of those who do not perceive the differences between different current-sources, from which, depending on the choice of trifling starting impulse - life or death originate.

This is reason why the Austrian government was requested merely to make a suitable location available at their expense, where in all peace and quiet and with the help of familiarised assistants, it would be possible by practical examples to reveal to the world at large and to expose publicly the ur-causes of this indescribable misery and appalling poverty.

A strange twist of fate led me to the burial ground of an ancient culture on the 20th of May 1946. There people smirked, because they believed they were dealing with a madman, who described water as the blood of the Earth!

### 3.

## New Forms of Motion and Energy

### The Reactive Fuel Economy

Whose natural motive force is the naturalesquely copied space-curve motion of the Earth.

Leonstein, August 1945 (Schauberger Archives)

Centuries ago Galilei discovered that the Earth rotated about its peculiarly individual axis. Through the discovery that the good old Earth rotated - now recognised throughout the world - Galilei experienced all manner of difficulties, a case that is far from isolated, because all those who sift through ancient traditions and practices also have to suffer the full measure of unpleasant experiences and consequently have every reason to repay them with interest and compound interest when the right moment comes.

Unfortunately Galilei could not explain why the Earth actually rotates and what actually should be understood by the term its 'own' or more correctly its 'peculiar' axis. Had he also been able to pass on this information, then we would have been unlikely to have experienced this disastrous machine age. Nor would we have had to experience the lunacy of trying to build up a culture with the influences of fire and the usual forms of heat, which in Nature are used to decompose what is unsuitable for further development. And so it came to pass that the forests were senselessly sacrificed in order to produce the usual rising and expanding heat-forms, which propels flies to the ceiling in a mad rush, while freezing those on the floor. In addition the reserves of coal are as good as exhausted and those who control the meagre residual deposits no longer want to deliver the black diamonds, which are destined by Nature for higher purposes, to those to whom they were previously supplied.

Without coal there would be no water, and without water, no life. For in coal, as in certain other minerals, the elements of carbonic acid are present in

which in turn the allotropic<sup>1</sup> primary materials for growth and development also reside. Reacting to bio-centrifugence, these basic substances are liberated through the cycloid-space-curve-motion of the Earth and under the influence of reactive cooling substances, consume (bind) the counter-weighting oxygen. Reactive differences in potential are created in this way which express themselves as reactive differences in temperature, which on their part, as all-penetrating inner outward<->inward, upward<->downward dynamic influences, intensify the physical (external) form of movement. This leads to a renewed intensification of the inner dynamic processes, which once again act to stimulate additional motion. Thus it is absolutely no wonder that the good old Earth eternally rotates about her peculiarly unique axis, because in this special axis (viz. the shimmering shaft in a water vortex) that something ascends, which enables stationary trout to stand motionless amidst torrential flows and to flee upstream like lightning. A phenomenon inexplicable in terms of mechanics, because the trout must not only overcome its own weight, but also that of the counter-flowing dense and heavy spring water. Indeed it can escape upstream all the more rapidly, the faster the cold specifically heavier water-masses, which swirl about their own axes in exactly the same way that the Earth rotates about hers, enter its jaws and flow out of its gills through a system of cycloid-space-curves. In this way the particular axis is formed in which that something returns to its ur-source, which becomes free through this special rotating motion and the frictional motion produced by it. In becoming free in this way, it then draws the motion-generating form - in this case the trout - in its wake, because this counter-flowing energy-form is the force that enables everything that crawls and flies on this manure-heap Earth to overcome its own weight. In other words, it is the 'levitational force', without which there would be no life, no movement, no growth and naturally no gravitation either.

With this natural formative and levitative force, which only evolves through cycloid-space-curve-motion, machines of all kinds, both stationary and mobile, and even projectiles, can be operated at almost no cost and propelled at any desired speed on land, in and under water, and in the air.

This tremendous power arises from cold oxidative processes, which take place when stocks of bio-centrifugated carbonic acid - as was stated above - react to bio-centrifugence, and under the effects of certain other co-factors attain their relatively highest state of expansion (ray-form state). In this freed (liberated) state they consume (bind) the oxygenic elements, which - still unknown to science - react to centripetence. Becoming denser, the O-elements then withdraw into the axis and therefore have to be dispersed from there mechanically. Thus diffused, they must be made

<sup>1</sup> Allotropic — This refers to elements that exist in two or more different forms. — Ed.

palatable<sup>2</sup> in order to act as levitational fuel for the others (viz. the branches swaying in the wind, whose source of motion - the wind - also arises through reactive differences in temperature). The vertically disposed forces of cyclones, typhoons, hurricanes, etc. are also founded on this developmental process and owe their kinetic energy to cold processes of oxidation.

'Conventional' science and fire-spitting technology naturally do this very differently, indeed in a diametrically opposed fashion. They exploit hot processes of oxidation as the developmental basis for the build-up of a decomposive and retrogressive force, which in Nature is employed for the recall for reconstitution of what is unfit for development. No wonder therefore that this type of force reacts, with resistances that increase by the square, against the insanity of its wrongful exploitation for the purposes of the build-up of culture. Therefore the crowning law of today's technology, the conservation of energy law and the so-called heat equivalent are founded on an unnatural developmental basis. To put it plainly, contemporary science and its technology have backed the wrong horse and have ridden it for so long, or have sacrificed the available raw materials to power precisely the opposite force to such an extent as to drag in an economic collapse by its head and shoulders. It has not understood how to copy the ideal method of generating power and formative energy, or through the naturalesque transformation of inferior raw materials into quality products, how to make the natural sources of energy available in unlimited quantity for a virtually free, silent and development furthering mechanical power.

This ideal fuel is present in a latent state in the stones, which emit a cold golden glow when rubbed together under water - a sign that these energy-concentrations are mature and properly alloyed. Austria, and the Tyrol in particular, is exceptionally rich in such minerals, charged with allotropic formative and levitative substances, which can be used to generate reactive temperatures by very simple means. These can provide a quite ideal form of domestic heating and cooling, because it is in this way that Nature keeps the ground cool in summer and warm in winter. Thanks to this mineral abundance, Austria will become immensely rich, if only it has the will and the determination finally to rid itself of those, who do everything entirely back-to-front so as to secure their continuing existence as so-called experts and

<sup>2</sup> Palatable: Here Viktor Schauberger uses the word 'mundgerecht', which literally means 'suitable for the mouth'. As used here it refers to the processing or preparation of the oxygenic elements for consumption (binding) by the carbonates. The immediately following reference to the action of 'branches swaying in the wind' relates to the way that the leaves and branches of the mother-trees thus moved, break up or 'pre-masticate' as it were, the gross agglomerations of atmospheric gases, thereby refining them sufficiently for absorption by the delicate young saplings. This Viktor Schauberger describes in "Nature's Secrets Unveiled: In Transmutation Lies Eternity", p.11 of *The Fertile Earth*, Vol. III of the Ecotechnology series. It is process analogous to the production of 'pap' in earlier epochs, namely the feeding of babies through the pre-chewing of coarse foods by the mother prior to spitting them into the baby's mouth.—Ed.

specialists. For when things can be done simply, there is no longer any need for those who make everything complicated and upside-down.

Naturally, no normal thinking person will believe that he or she were so brain-washed at school and in church as to be made to believe in the existence of rigid laws and dogmas in a Nature so rich in interchanges of substances and metabolic processes. For this reason it is still necessary to take a small example as an aid, which every respectable Tyrolean knows, who loves a good wine, even if a little dry.

It is known that a good, light and palatable old wine comes into being through fermentation in a cellar. This is none other than a form of digestive process in which cycloid-space-curve-motion naturally plays a part - a motion the naturalistic doctor calls the 'life-creating spiral' and the biotechnician 'double spiral wave motion' (viz. the cycloid movement of the blood, to which we owe the build-up of mental essences, the creation of thoughts, the formation of our bones and flesh, reproductive embryos and of course, the possibility of overcoming our own physical weight).

When the fruit juices that have flourished in the Sun begin to ferment, it is a sign that reactive temperature differences have triggered the fermenting movement, which in the initial stages has to separate the inferior from the superior. The former will be separated and centrifugated out through cycloid-space-curve-motion. The latter interconnects with itself, as it were, and the product of this remarkable marriage process is that something, which also brings us out of the delicately balanced equilibrium that the Earth ceaselessly enjoys. Not being in a state of stable equilibrium, she has constantly to rotate about her own axis in a form of movement that declinates and oscillates in two directions. This is how she generates the inversely symmetrically- and inversely proportionally-acting force, which enables everything that crawls and flies on this dung-heap Earth to move 'originally' (autonomously) in order to seek out its food, which also contains allotropic energy-producing substances. These are then broken down through the vibration of the organs, leading to the familiar development of physical strength and mental vigour, whose ur-causes have not been perceived by physico-technical scientists, who calculate with common calories and measure them with decimal scales and rulers. Moreover, they also believe they have captured everything with their tweezers that is proper to Nature. Unfortunately, however, this cannot be accomplished with such an instrument, because the producer of 'measure' and 'weight' is an imperceptible extra-ordinary energy-form, which as the 'essential' is the 'reactivated' itself, which actively moves the ordinary.

To return to what is contained in good vintage wine, the process is reversed from the outset, for in this case once again activated forces move us reactively, i.e. dislodge us from a state of stable equilibrium. As future bio-technologists, it is with these latter forces that we wish to maintain this instability. For in so



doing we have merely to brake the continuously running bio-machines with a heavy operating load in order finally to solve the whole problem of power and fuel in a truly super-ideal way for through these same forces the diverse foodstuffs, the various forms of growth also come into being, which are known to be endowed with these natural formative and levitative forces for the duration of life. Being thus endowed, they bind a major portion of these elemental levitative forces, or brake them by means of their weight. For this reason all the more regrowth must occur, the greater the production of formative and levitative forces through cycloid-space-curve-motion. Conversely, because of this increase in raw materials, increased stocks of quality matter will subsequently be produced through which the levitational forces will again be intensified.

This two-fold interplay of perpetual motion can be directly observed and studied in deep, cool cellars, for through differences in temperature, what has grown large in the Sun and then reduced in size by squashing, will be moved 'cyloidally' in the cellar. First refined, then made 'cloudy', it slowly becomes clear after termination of this adolescent period. This is how wise Nature operates, who is known to have unlimited developmental periods at her disposition for all things. We, poor souls, to whom only a single, unique life is available in which we will also be forced to make use of cycloid-space-curve-motion in order to alleviate almost intolerable reactive energies through their abreaction, will have to behave more sensibly in order to become somewhat more blissful while still on this Earth than has been the case due to the efforts of 'active' technicians. In other words, we must reverse the way things are done. Cycloid-space-curve-motion must therefore be given pride of place, which logically leads to the almost cost-free mechanical generation of reactive differences in potential, which in turn give rise to increased and intensified active differences in motion. Harnessed once more, these trigger further high-grade differences in potential of a reactive nature, and so on and so forth until temperatures and reactive forces of such a kind are triggered that it is a veritable art to devise an operating load heavy enough to brake and contro these elemental suctional and pressural forces. At the right time, therefore, we must keep our eyes open for the specialists and experts, who function as super-brakes on development!! Most certainly, however, we must replace those, who today brake the normal course of development with the reversed interplay of forces, which they do in such a way as to increase and intensify precisely those kinds of energy that promote decomposition and the expulsion of what is unsuitable for further development. In so doing they trigger a form of perpetual motion, because here too the self-intensifying decomposive and repulsive forces also increase by the square owing to the cycloid-space-curve-motion of the Earth. Sadly they do not see what they have themselves created, namely boundless decline and disintegration instead of an equally

boundless self-intensifying formative build-up, which also results from the universally operating cycloid-space-curve-motion. This would happen merely by reversing the process that they and physico-technical science teach in school and church alike. Consequently - and one can believe it or not - there are two marvellously functioning forms of perpetual motion that direct and produce the eternal coming into being and passing away. For a change, it would be worth setting the other in motion, in order - as already stated - to become somewhat more blissful while actually on Earth than we are under the direction of those who, apart from heating our living spaces unnaturally, also commit all manner of other blunders, for which the present state of affairs is proof. And thus on the next and final page everyone can seek out for themselves what best pleases or appeals to them.

## The Practical Application of Cycloid-Space-Curve-Motion arising from Processes of Cold Oxidation

### Forestry

This would involve the propagation and build-up of fast-growing species of valuable timber by restoring cycloid-space-curve-motion through the re-establishment of naturalesque proportions in the intermixture of various crown and root systems. This will resuscitate the reactive temperature-differences (the reinstatement of microclimates through the graduated arrangement of over- and understoreys and juxtaposition of species) through which the heat-consuming upflows of refreshing and cooling substances ascend like cycloid whirlwinds, which trigger cold processes of oxidation enabling the propagation of species of fine timber on the forest floor (formation of the germinating zone).

### Agriculture

Here the concern would be for the propagation and build-up fast-growing high-quality fruits and cereals through the selection and correct distribution of principal crops and intercrops through the supply of allotropic fat-concentrations in a liquid, vaporous or even an energetic state - the supply of noble water by underground means or the direct supply of noble elements by means of Repulsators (see figs. 24-26).

## Water Supply

The application of this form of motion would bring about the revivification of sluggish, stale, tired, fish deficient, bacterially polluted brooks, streams and rivers through the artificial reinstatement of cycloid-space-curve-motion in draining water.<sup>3</sup> In other words, the reconfiguration of truncated and straightened channels in which the more exalted formative and transformative processes can no longer occur, due to the absence of cycloid motion. Therefore the stocks of basic allotropic heat-imparting substances are no longer consumed (bound) and the improperly regulated watercourses inevitably become warm, stale, devoid of fish and infected with bacteria, because the revivifying form of motion is missing or has been disrupted or eliminated by smooth-walled bank rectification.

## Energy Supply

Here such motion can be practically applied to the following:

- (a) To the liquefaction of coal or carbonic-acid-bearing minerals by way of cold (cycloid) systems of flow, e.g. the generation of incombustible, gas-deficient and highly expansive, dynagen-rich 'explosive' water and drive water with the aid of Repulsators for the purpose of producing highly expansive pressures for driving machines of all kinds.
- (b) To the etherisation of ordinary air-masses through the re-pulsive precipitation of inferior waste matter (water-like carrier substances) and the enhancement of im-plosive suctional forces through the generation of an 'organic vacuum', the co-active counterforce to the above high-pressure expansion, by means of Repulsines (see figs. 30-33).
- (c) the fabrication of naturalesquely designed water turbines, pumps, etc. (see figs. 11-13) with about a 90-fold increase in output and performance under otherwise equal conditions through the combination of both components of motion (pressural and suctional forces in a reactive state) on a common developmental axis.
- (d) To the heating and cooling of living spaces with the aid of allotropic mineral elements through the intensification of the re-pulsive power and performance of expansive substances (the radiation of stocks of basic elements from selenium cells. With slight stimulation these produce reactive forms of temperature, which indirectly result in a form of cooling that acts from below upwards and a diffuse form of heat that acts from

<sup>3</sup> See channel with flow guides in fig.8 and patent figs. on p.207 of *The Water Wizard*, Vol. I of the *Ecotechnology series*. — Ed.

above downwards, all of which result in the best and cheapest wood-less and coal-less air-conditioning (see the Klimator, figs. 27 & 28). (e) To a roughly 90% increase in electricity production through the use of repulsive dynamos, the generation of cold light, etc. by means of cycloid flow systems, etc.

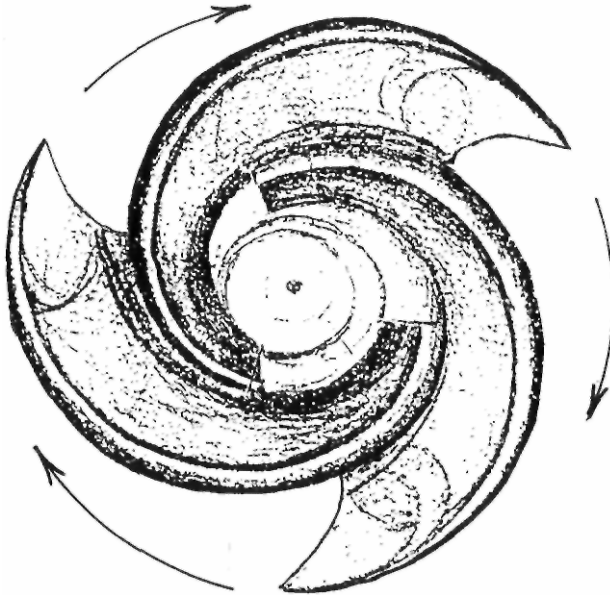

Fig. 11: 3-blade Bio-impeller

### In General

In the same way that it would be impossible, for example, for human beings and animals to reproduce and further develop (increase and qualitatively improve), were Nature not to enforce an interaction between their primary sexual substances through intolerable urge-driven differences in tension, which function reactively, there would likewise be no possibility for the reproduction and further development of plants, minerals and metals, and the physical (active) forms of heat and cold. Today's science is not only founded on a false developmental basis, but also on too low a level of knowledge. It ignores the formative reaction and using combustion processes gives pride of

<sup>4</sup> Excremental or faecal technology: This expression reflects Viktor Schauberg's view that today's technology is founded on the wrongful combustion of waste matter, such as oil and coal. As the energy-deficient physical residues of formerly vital substances, i.e. the expelled by-products of interactions of a purely energetic nature, he regards them as Nature's faecal matter — hence the term 'excremental'.

place to an economy powered by excremental matter. For this reason an economic decline is inevitable. The reintroduction of cycloid-space-curve-motion signifies the reinstatement of the normal progress and processes of development and the immediate alleviation of privation and penury.

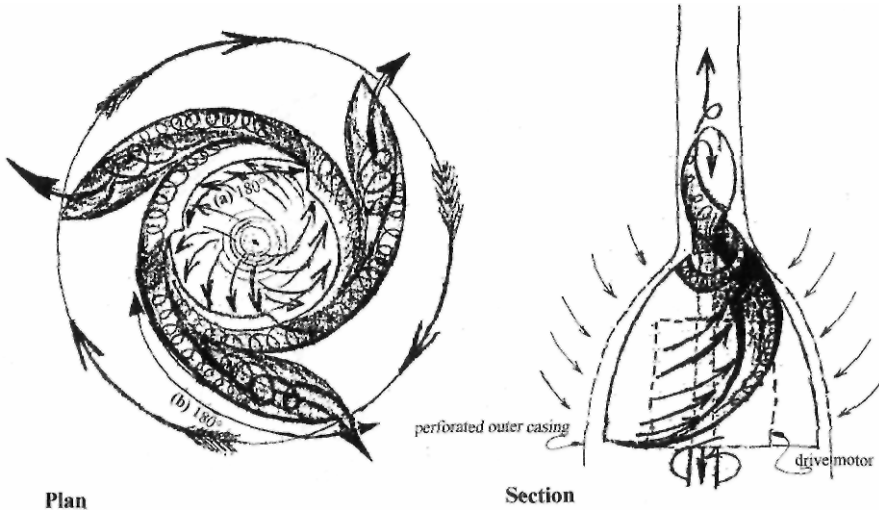

Plan

Section

The water must rotate about itself and within itself (about its own longitudinal axis) through  $180^\circ$  on both upper (a) and lower (b) sections of the turbine blade, making a full revolution of  $360^\circ$ .

Fig. 12: 3-blade Bioturbine

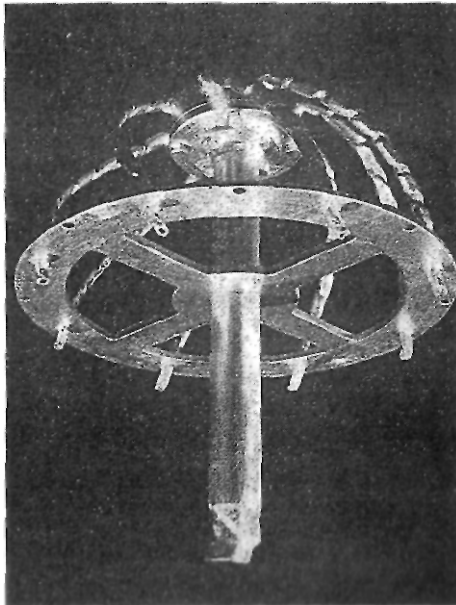

Fig. 13: Bioturbine rotor with whorl-pipes

## The Economy Founded on Reactively Produced Energy as the Naturalesque Source of Mechanical Power

Leonstein, August 1945, (Schauberger Archives)

In the following a ticklish theme will be addressed briefly, about which it is difficult to remain objective for a variety of reasons. Even in the present situation it is not an easy matter not to say too much, nor too little. In a certain sense, a golden middle way must be sought in order to identify clearly those things that which will determine the future fate of humanity. A way out will also be shown to those who have suffered serious setbacks from every quarter, leaving many a bitter after-taste behind. In many instances, these were reminiscent of the religious inquisitions, when it was also believed that a person's faith could be fortified with all manner of instruments of torture. Similar torment had to be endured by the people, which will be just as little forgotten as the satyr-like excesses of those who, as former dictators, should be held responsible for the most heinous offences. For the German people these will foreshadow a lasting shame, although throughout the ages there were people, who did precisely such things whenever their retention of power was threatened - a sign that there was no other solution to keeping their heads above water a little longer.

In every case, however, it was always those who suffered either from too great a trust or from a belief in salvation already bordering on insanity, and therefore incapable of judging for themselves, who had to pay the penalty. Thus they became the victims of those, who already knew how to manipulate history so cleverly, that in the end all that was left for the unsuspecting co-travellers on this road, was to be hung along with the guilty. And thus they were doubtlessly sympathetic towards the present English Labour Party, when it no longer felt obliged to support those elements of British foreign policy of the preceding decade, which in the House of Commons had been criticised by the rank and file of the Labour movement. So much briefly for politics per se in regard to the universal analysis of day-to-day political decision-making, which plays such a major role in these present times that it is just as difficult to obtain an overview and assessment of it, as it is the contents of pastoral letters, or the quite uncanny silence of those, who as perhaps the most successful businessmen, have the keenest interest in the present state of affairs, but who say absolutely nothing about it for the time being. For many centuries my forefathers served as foresters under the bishop's crook and being in this particular profession, experienced things an outsider could never even imagine. This is because the forester's whole approach to life predisposes him to expect the full measure of certain human weaknesses.

The behaviour of the timber merchants was therefore not totally unfamiliar to him, who in this regard and in other ways too would think nothing of thoroughly taking the next good fellow for a ride whenever the opportunity presented itself.

As a former Master of the Wilderness and hunting guide to a princely house, I myself have had a profound insight into the customs and practices of those circles, who consider it a matter of course to exploit their underlings as a means to an end, so as to be able to enjoy their lives and occasionally to afford themselves pleasures, which, were it conceivably possible, would even bring a blush to the face of a lecherous old buck well versed in such affairs. In any event, charity has never yet been the motivating sentiment of those, who coined this beautiful word or who made all manner of promises on this account, which were impossible to keep from the very outset for reasons that will be elaborated in greater detail in what follows. This should not be viewed as a cheap critique, however, but rather as a necessity in order to expose the root of the evil and thus place a finger on the actual wound. With very few exceptions, this will be experienced as painful or at least as unpleasant. Unless this is done, however, the concept of an 'economy founded on reactive energies' cannot be explained.

Without 'reaction' there would be no growth and further development, no increase of any kind, and no qualitative improvement. Similarly there would be no refined matter, no raw material, no motion and no life.

What triggers this reaction is the well-known dynamics of the sexual urge, which re-establishes equilibrium between intolerable differences in tension and potential. Because these differences are always present, this original form of movement will constantly be provoked by a motivating force that never wanes. As a form of motion, we are here primarily concerned with the motion that the Earth has demonstrated to us since the beginning of time. Referred to as 'cycloid-space-curve-motion', it is synonymous with what the naturalistic doctor calls the 'life-creating life-spiral', and the biotechnologist calls 'double screw-form wave motion'.

It is common knowledge that Galilei discovered this motion and because of it, suffered a veritable martyrdom. Up to now nobody has been able to explain why secular and religious science were so hugely disturbed by this discovery. Since then there has no longer been any doubt that the Earth rotates about its own axis. Why it does so, and what purpose is served by this peculiar inclined, gyrating motion, which oscillates to and fro along two different axes has so far never been explained.<sup>5</sup>

Every attempt to provide an explanation was thwarted due to the strenuous resistance of those, who had already made Galilei's life difficult. This awoke in me such a interest in the true nature of this peculiar and unique motion,

<sup>5</sup> See figs. 6a, 6b & 7, Nature as Teacher, Vol. II of the Ecotechnology series. — Ed.

that I made it my life's work to investigate it down to the smallest details. In spite of the victimisation and harassment, this intention was also carried through to the point where, as perhaps the only one who really knew, I had the right to expose with ruthless clarity, the reasons why even today this explanation is still so opposed and no stone left unturned to suppress it.

Since there would be little point in providing a long and detailed preliminary scientific explanation, a simple example that can be understood by everyone will suffice to explain the nature of this form of motion, which we all have to thank for all we see around us or are otherwise aware of. Only one thing remains hidden from us and that is the 'reactive' temperature-form. This actually involves higher undetectable temperature differences, which reveal the presence of two opposing 'ur-primordial' primary substances, which explain the profound mystery of the genesis of all life or inner motion. Since this will invalidate all forms of contemporary belief and science, it seems to be the real reason why an explanation is shunned in such circles.

Whether this is intentional or unintentional will not and cannot be addressed here. One thing should be emphasised at the outset, namely, that it is futile to continue to oppose this explanation, which is in the interest of all humanity, because widespread interest in this mysterious form of motion has already been so aroused that no power on Earth is in a position to frustrate it.

But now to the example mentioned earlier: In the 'normal' course of cellar fermentation two different (reactive and active) temperature differences (this two-fold concept will be described later) trigger off that special form of motion which, after the expulsion of the less valuable in two opposite directions, gives rise to ethereal energetic matrices that also operate in the same two directions. A destructive force that self-intensifies by the square is activated, whose function is to return to the Earth as quickly as possible, everything that would inflict damage on that which explains all life and movement, and which moves in the other direction (vertically) towards its objective.

This self-generating force, which also intensifies by the square, not only refutes above all the conservation of energy law, the law of gravity and the Second Law of Thermodynamics; in short, all rigid laws of whatever kind, but also renders just as invalid, all those basic tenets and principles impossible in Nature, such as the dogmatic axioms of theology. By enshrining these so-called laws, both science and theology have committed several blunders, and through this identification of their intentionally or unintentionally promulgated fallacies, have made fools of themselves for all time. In any event, they gained an advantage in this way, the loss of which will now for the first time reveal the unholy consequences of the greatest deception, although it could merely be self-deceit. For if the process is reversed, i.e. if the form of motion actuated by the above temperature differences is given first place in naturalesquely constructed and shaped development-facilitating devices,



then even higher forms of temperature influence evolve with which all that we so commonly call 'growth' can be regulated at will. In addition, we are provided with waxing, self-generating motive forces, which intensify by the square, making mechanical power of every kind virtually free of cost and therefore worthless according to today's values. According to higher concepts, however, they become valuable for the first time, for in comparison the motive forces in use today are not only as good as worthless, but are also responsible for the fact that things are deteriorating all the more rapidly, the wider the scope of today's technology, or its intensification. This realisation is consistent with the fact that this excremental technology, which exploits these perverted energies for propulsion, is virtually at an end, because oil is already in short supply and the stocks of wood and coal are quite unable to cover the demand. As things now stand, nobody knows what is to replace them.

We shall now address what is encompassed by the title of this article. Rather than present a long and detailed description or explanation, the only proper course of action would simply be to demonstrate the new source of energy, as most people would suggest. Certainly that would be the right thing to do. However, various reasons argue against this, which should and must be taken into account. Firstly, in the present times [immediately post-WW II] it is not at all easy to obtain the necessary materials, suitable skilled labour, machines, etc., all of which are required to fabricate these bio-machines. Moreover, and understandably so, a justifiable disbelief also prevails when such Utopian things are to be produced and also have to be explained in order to begin the laborious creation of a first prototype, because today nobody can be motivated to work on frivolities. Over the last few years extremely hard work was done under almost impossible conditions and the most extraordinary results achieved, all of which seemed ordained to arouse a zest for further work. However, the desire to work is by no means overwhelming and entirely justifiable suspicion is everywhere. This is compounded by the fact that in spite of all the curiosity, nobody wants to be ridiculed for being taken for a ride by a supposed visionary.

All this is more or less irrelevant, however, because the preliminary work has now reached a point where these difficulties will somehow yet be overcome, because the whole thing can be looked at from many angles. Moreover, because no responsibility must be carried for this indubitably fantastic affair, some will therefore participate when nothing is risked by doing so, because everything will be honestly and properly paid for, which even these days, when money is nothing more than a scrap of more or less beautifully printed paper, is a normal incentive for those, who gladly accumulate funds for their future leisure or out of sheer passion to succeed.

The second reason why one cannot merely blurt out the news about the Repulsine (see figs. 30-33) and the Repulsator (see figs. 24-26) is because the

already very shaky scientific edifice would come tumbling down, if the full scope of the reactive energy economy should become known too quickly. An upheaval of such a kind would then arise, which could not be endured in these days of food shortages, and the baby would be thrown out with the bath-water by those, who have only one idea left: somehow to struggle through life and to be free of all problems. Were this implemented, however, then the most marvellous things would come to life again, which compared to the present world situation would be a paradise. The trick therefore is - how do I tell the innocent children that the end has come for all manner of lusts for power, because a natural power is now appearing, before which everything else must unconditionally capitulate. Today this new power rejoices over the victory, which was brought about by the fact that the Germans - and this can be examined from any desired viewpoint - were unfortunately the best exponents of a technology founded on faecal matter. Unhappily they exploited precisely those expulsive energies that enable us, for example, to rid ourselves of those substances so vital to the Earth for maintaining the eternal renewal of her motive forces. With the aid of these earthly and other waste materials she recreates everything anew, which our evolutionally older descendants absolutely require for their various necessities of life. For this reason wise Nature will not hesitate much longer before she clears everything off the green dissection-table with a single sweep of the hand, as it were, upon which, using decimal scales and an inch ruler, attempts were made to discover the 'essence', namely, that which provides for the weight and measure of all things. And thus, instead of specific elements they found absolutely heavy remnants, which they then declared to be 'atoms'. That these remnants of a former organic whole, which have been artificially rendered potential-less (stripped of life-force, so to speak), interact in a lively fashion, is quite obvious. Under no circumstances, however, do the products of synthesis that produce higher quality products come into being in this way, but only active forms of heat and cold. These promote the process of decay through further interactions, which in turn give rise to the decomposive and retrogressive factors that promote an accelerated disintegration as well as the annihilating energies that intensify by the square. That these energy-forms, which foster decomposition and are possessed of a force of resistance that increases by the square, contradict the irrational assumption that they actually further the build-up of culture, is perhaps only incomprehensible to those who know nothing of the specific counter-elements and who, because of a tragic error, established the crowning law of contemporary technology, such that under all circumstances the resistance must increase by the square of the velocity. The specific counter-form, the upward falling weight as it were, comes into being when etherialised substances are transferred to the 4th dimension. This happens, due to the fact that negatively potentiated constituents of carbonic

acid are bio-centrifugated with the aid of cycloid space-curve motion and so strongly expanded by mechanical means, that they become free, unipolar, cool and highly active in a kind of ray-form. They consume (bind) the oxygenes which become inactive due to the effect of this reactive temperature influence, when these seminal substances<sup>6</sup>, which concentrate around the longitudinal axis are dispersed mechanically. In this way they are made palatable as it were, in a manner similar to branches which, swayed up and down by the wind, prepare or pre-masticate the food for the young saplings growing under the protection of the mother-trees. The ultimate products of this digestive process are the high-grade forms of fructigen which, through a progressive series of transformative and formative processes, are produced in similar fashion, when one entity is consumed by a higher one, which in turn falls victim to an even higher lover. The fructigens thus produced are finally consumed by the Earth herself, who gives upward birth to primary products of synthesis, which are created through a progressive series of interactions involving the etherealisation of former fatty-matter derived, for example, from naturalesquely broken down and transformed worm-fat. This etherealising process then re-produces the more highly influential substances in an energetic state, which the community of worm descendants once more brings to life and moves 'originally'.

However, to return once more to the cellar fermentation mentioned earlier, no combustible essential oils (alcohol formations) are formed, when through self-intensifying cooling influences, cold oxidising processes take place, which give rise to increased and qualitatively enhanced energy-forms, providing the metabolic process is reversed. That is to say, cycloid motion has to be initiated first. As a result, precisely those high-grade energy products arise, which influence the way in which the end-products and their later derivatives are created, and which then endow them with multiplying and quality improving potencies.

This perpetuum mobile is also involved when the developmental process is intensified with Repulsines and, for example, the substances contained in the air are subjected to the fermentation process outlined above. In this way the same thing is achieved practically and factually, but in a slightly different active form. In the same way that the end-products influence the more basic factors and cause them to move, they also cause them to be displaced upwards at cyclonic speeds; a process that also gives rise to reactive forms of temperature at the same time. Using these reactive temperature-forms the floor can be made warm in a rational way. In spite of the forces that help us to overcome our own body-weight so effortlessly, providing both metabolic processes

<sup>6</sup> Seminal or fertilising substances: This relates to oxygen in all its forms. In Viktor Schiuberger's view oxygen is not of the Earth, but comes from above. As a lower provenance sunlight, it is male fertilising substance, whereas the mother substances, so called 'carbones' originate from within the Earth. — Ed.

function unimpededly, we still have to creep and crawl around on this floor in a way that houseflies cannot emulate, which are perhaps the only beneficiaries of these incongruous conventional methods of heating. These methods will also almost completely exhaust the reserves of coal, which is no longer available in sufficient quantity, or is impossible to deliver to the point of use with the present means of transport (the true energy-gluttons), even if sufficient quantities were available for this coming catastrophic winter [1945-46]. It is therefore understandable that those who are threatened with freezing to death and starvation will fall upon this new method of heating and transport like beasts of prey, unless the matter is put in hand with extreme caution. This is the principal reason why heating with mineral substances, with which reactive temperature-forms can be produced virtually without cost, must be inaugurated with great care. These reactive temperatures are activated merely when various allotropic substances are gently stimulated by active heat influences.

To say more about this here would be pointless, because up to now nobody knew anything about the ur-causal energies that dwell in every substance, and especially in very ordinary pebbles. When these are rubbed together under water they produce a gleam of cold light. This is an indication that the bipolar basic elements are mature, ready for release and can be used to generate those forms of temperature, which maintain us and all we see around us in the unstable thermal equilibrium that maintains health.

In an already higher form as invisible suspensions, these same substances are contained in the carrier of life-substances - water - and can be made free and active with the use of Repulsators. In their relatively highest evolved form these bacteriophagous threshold stocks are to be found in the air. These indifferent elements of intermediate substances can be liberated by means of cycloid-space-curve-motion in so-called Repulsines, resulting in the intimate fusing of the former carrier-substances, which exit from the lower end of the apparatus, and immediately interact with the surrounding difference-matter, namely substances of a highly polarised nature. This leads to the formation of new juvenile air, which strives to displace itself upwards, because this increased, qualitatively-improved, evolutionally-older air cannot mix with the surrounding older air-masses, which have a different potential.

Conversely, similar formative and levitative energies are created in front of the intake through primary processes of synthesis. These, for example, enable the trout to stand motionless in torrential streams, or to flee like lightning upstream when danger threatens. This is a phenomenon that cannot be explained mechanically, because the free-standing trout must not only overcome its own body-weight, but also the weight of the oncoming water. It overcomes this all the more easily, the more rapidly and torrentially the water containing these valuable threshold suspensions flows, which are reactivated

by the cycloid-space-curve systems of the trout's gills. In consort with the above supplementary energies, which squeeze the tear-shaped body of the trout forwards (see fig. 38(a), they then give rise to the above phenomenon. In a similar manner, naturalesquely constructed aeroplanes, submarines, or long-range weapons (air and water torpedoes) can be made to move silently through the air or water at any desired speed and almost without cost. Stationary machines of all kinds can also be powered by reactive fuels, which require neither mining nor other forms of extraction, because they are already present in superfluity. These are the allotropic bacteriophagous elements, which merely await the cycloid motive impulse in order to function as miniature dynamos and which through their translatory energies automatically produce the power that intensifies by the square. This explains the tremendously high velocities characteristic of those most highly developed expansive forces - ray formations.

In order to throw more light on their origins, there are two types of seeds:

1. Those responsible for all physical forms of growth, which according to their degree of maturity fall down and upon returning into the earth, germinate and produce the increased and qualitatively ennobled forms of growth. These are the provenances of sweet-matter (carbones), or the
2. Seminal fruits, which having fulfilled their reproductive function, become dormant, die off and become the seminal substances, as it were, for the creation of quality matter, which after decomposition are then transmuted through 'cycloid-space-curve-motion'.

By means of progressive interactions with reactive forms of potential, this results in the segregation of those elements, which in the form of allotropic intermediate substances were left untouched, whereas the more inferior substances descend even further under even stronger influences of heat and are even further broken down. Once again what is still useful will be precipitated out and deposited, until the most inferior substances of all attain their relatively lowest state of evolvment and thereby their greatest degree of separation from the most noble, which on the other side has risen to the highest state. In terms of its height and depth, this is how the above threshold-element depot comes into being. Therefore through a graduated process of deposition according to quality, the variously potentiated indifferent elements have different developmental periods. Those with a smaller separation interact earlier than the others, and logically, have to cover shorter developmental paths in order to reach the next higher evolved state.

The trick was then to discover the appropriate development-facilitating forms in which, through intensified cycloid motion, even the relatively low-quality seminal-fruits sucked in by Repulsines together with their carrier

substances of water or air, could also be whirled around at high speed in cycloid-space-curves. At the same time oligodynamic (decay-promoting) and catalytic (growth promoting) secondary influences also evolve and in this way the process of formation and transformation can take place within seconds due to the slip-pressures and suctional forces, which intensify by the square. This is how it is possible to build up the 'ur-primordial' levitative and supplementary forces in the form of metaphysical suctional and pressural forces almost without cost, in other words the creation of an energy-gradient, which 'ur-originates', as it were, from dynamic elements in a latent state. This opens the way for practically exploitable atom-transformation, or expressed otherwise, for the transubstantiation of former matter (fatty-matter) into negatively potentiated dynagens, those spiritual animating and dynamising energies; a transmutation that has been demonstrated many times over two millennia by the priest when making the symbolic sign of the cross over the Holy Grail - the extreme egg-shape (the calyx). All that hitherto was lacking was the practical design - the model - that proves what is actually obvious, namely, that with annihilating fire and decay-promoting forms of heat, no form of culture can develop. These models, which are now operational and available, merely await the 'extreme unction', as it were, in order to set them in motion and thus inaugurate a new age of development, wherein all privation and other problems will come to a natural end.

### Explosion and Implosion (Expansion and Impansion) from a Scientific and Biological Viewpoint.

Viktor Schauburger, Linz, Austria, 16.01.1956, Implosion Magazine, No. 113, p. 63.

Expansions are retarded explosive effects in the realm of basic substances, in which decentrating (expanding) reactive effects of a subordinate order are freed.

Impansions are slow processes of densation, which for example, can be exploited in so-called chillers or refrigerating machines and are to be viewed as normal de-stressing processes.

Explosion is chemical reaction that takes place extremely rapidly, in which a large increase in pressure occurs due to large quantities of hot gases. Explosions are always innately destructive. They therefore function in a life-harming way.

Implosion is a biochemical reaction and takes place equally rapidly, during which a strong increase in low pressure occurs, whose active force increases by the square of the rate of the decline in heat.

The cause of an explosion is the sudden binding by highly charged oxygen, which at  $+40^{\circ}\text{C}$  ( $104^{\circ}\text{F}$ ) becomes free and aggressive, of the sweet substances generally known as carbones, which become increasingly passive (inactive) with pressure and increase in heat.

With explosions vorticity (turbulence) always occurs, resulting in a reduction in the velocity of the through-flowing substance, leading in turn to cavitation, viz. the corrosion on ships propeller or pressure screws in turbines. In particular when snow meltwater or glacier water is centrifugated. In such cases radar-like retroactive re-actions takes place, which as detonating events, have a shattering effect. The detonation velocity can be a thousand times greater than the normal combustion velocity, which explains, for example, why the resistance to motion increases by the square in all explosion and expansion machines, which also increases by the square of the velocity of an increase in heat. It therefore acts to impede motion.

The cause of an implosion is the sudden binding (emulsion) of oxygen, which becomes passive (inactive) with a decrease in heat and in this state is consumed by the sweet substances, which attain their charged state at  $+4^{\circ}\text{C}$  ( $39.2^{\circ}\text{F}$ ). The mechanical atomisation of the oxygen is necessary, however.

With implosions a molecular ordering takes place in a radial->axial direction and therefore a suctional effect takes place in the axis, where the most vigorous decrease in heat and pressure occurs. This attracts, indraws, concentrates and binds (emulsifies) the oxygen, which gives rise to diamagnetism. This is precisely the opposite of the atomic pressural force, generally known as electricity. With implosion, detonationless retro-suctional effects occur in the core zone, which promote a higher grade emulsive process, namely the binding of the oxygen, which becomes increasingly passive the closer it is to the centre of flow. This results in the collapse of the peripheral masses, the release of the through-flowing substance from the walls, and thereby to an almost frictionless increase in the velocity of the self-inwinding through-flowing material, which accelerates by the square of the velocity of a falling heat gradient.

# New Views of Electromagnetism

## Magnetism - Electricism

14th June 1948, Implosion Magazine, No. 123, pp 18-23

**M**agnetism and electricism are the two opposing metaphysical energy-forms, which regulate life and death and which dwell in every solid, liquid and gaseous (aeriform) mass (matter) in an allotropic and latent transitional state. They await the all-important developmental impulse in order to be transformed into higher-grade (life-affirming) or lower-grade (life-negating) forms of energy. In the former case a magnetolytic dissociation process plays the mediatory role and in the latter an electrolytic. The belief that magnetism was a passive and uninteresting by-product of electricism arose merely because nobody was aware of the type of motion that gives rise to higher-grade energy-forms. Nor were they aware of the associated dynamic shapes with which latent bipolar dynagens and their carrier-substance can be accelerated in such a way naturalesquely that, in accordance with the equation  $F = ma$ , the force responsible for the increase in substance and qualitative improvement (ennoblement) arises with whose aid the relatively highest grade energy-form can come into being. This special form of motion, still unknown to conventional science, can magnetise a tripolar mass of air or water up to a maximum of 36% virtually without cost. To do this a particularly constructed, profiled and suitably alloyed form is required, which promotes the evolvment of a developmentally progressive energy, the power of which increases in proportion to the centripetating rotational velocity. In this process it is possible to overcome physical weight and mental torpor effortlessly at almost no expense. Accordingly, magnetism is therefore levitism, the creative (metaphysical) counterforce to electricism, the latter being the decomposive energy-form that actuates gravitism, or physical and mental relapse (the death state).



In this regard the following must be explained: Viewed as a whole, all matter is a tripolar product of motion in which lower-grade dynagen concentrations, i.e. higher-grade qualigen in a pre-developmental embryonic state (here referred to as vitamin molecules), are present in an allotropic (polymorphic - solid, liquid, gaseous) state.

These concentrations of subtle matter are bacteriophagous threshold conformations (being neither corpuscular, nor metaphysical embryos) in which the opposing energy-forms mentioned at the beginning are suspended, which oscillate gently in liquid or gaseous media in a wavering state of equilibrium. That is to say, they possess too much levitational force to gravitate and too much lower-grade mass to levitate autonomously. Their inner processes of motion are sustained by the ambient differences in temperature. These, however, are insufficient to determine the fate of these threshold substances as they vacillate at this cross-roads.

The decisive factor here is *il primo movere*. This is the mysterious motive impulse that Leonardo da Vinci sought in vain during his whole life in order to activate *il primo motore*, the organic machine, in such a way that the intent of the original mobility-enabler - Life - could take its natural course.

This can be achieved when the rhythmical process of motion - an interplay between components (sub-forces) of suction and pressure - is activated in a manner in accord with natural development. That is to say, the suctional component, which builds up the invigorating motive influence prevails and outweighs the fatigue-inducing pressural component.

In this case magnetism, the levitating, life-affirming and relatively highest grade energy-form, springs forth from the above dynagen capsules - the vitamin molecules.

This is to be compared with the tragic error in motion made by today's technologists, hydraulicists and dynamicists inasmuch as they produced the reversed motive impulse in all machines, whether for systems of conveyance or for the generation of light and temperature. In place of the invigorating suctional component they allowed the pressural component to prevail and predominate, which has a fatiguing effect on the moved mass.

In order to give the reader some idea of the far-reaching repercussions of this disastrous misunderstanding of motion, the following will explain how energies that function in different ways can be built up.

Energy in its almost purest state is produced when any given mass (e.g. air or water) is propelled above the speed of sound in order to separate the lower from the higher grade and to ennoble the latter through magnetolytic (formative) chain reactions. This gives rise to the substance-increasing retro-influent<sup>1</sup> energy-form, which endows what has been increased with reproductive and evolutive potency.

<sup>1</sup> retro-influent, refers to the energy form that reverts to physical substance in contrast to that which exalts to metaphysical dimensions of energy. — Ed.

All systems of technical, hydraulic and dynamic motion cause the axial->radial dissociation of the tripolar masses of air and water, through which pressure, which generates lower-grade heat-forms, increases by the square of the centrifugating rotational velocity. This results in electrolytic dissociative processes, wherein the oxygen becomes free, unipolar and highly aggressive, and consumes and digests the carbonates (fermented fatty-matter), which become passive under this heat influence.

Precisely the opposite dissociation is inaugurated when the suctional component prevails or is dominant. This is because suction, which produces higher-grade coolness, increases in proportion to the centripetating rotational velocity. This invigorating (quality-enhancing) suctional effect can only be created when a tripolar mass of water or air is radially->axially rotated at high speed about its own axis.

This biotechnical system of mass acceleration produces upwardly flowing magnetism, whose formative and levitative force increases by the square of the radial->axial rotational velocity (see fig. 14) in a naturalesquely constructed, contoured and alloyed generating device. This system is still unknown to today's purely mechanistic science, which is founded on too low a level of knowledge.

For this reason any expert opinion from this quarter is totally uninteresting, because the scientists, who failed to perceive the natural process of development, formulated rigid laws and dogma that do not exist in Nature's rhythmical interplay of forces.

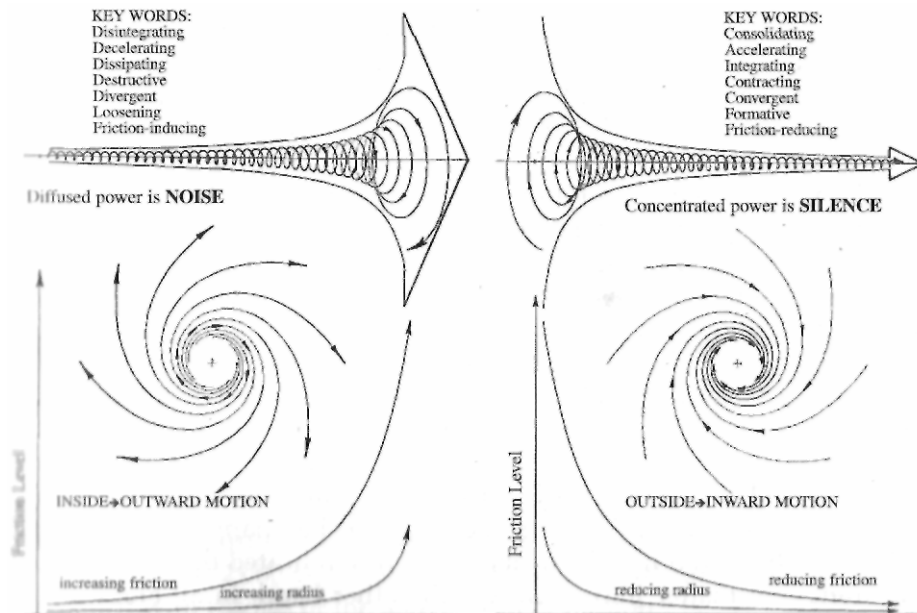

Fig. 14: Comparison between axial->radial (inside->outwards), radial->axial (outside->inwards) motion

No law of energy conservation, nor any heat or other equivalence exists and hence no insuperable law of gravity, for all that is necessary is merely to accelerate a mass of ordinary water or air naturalesquely in order to generate upwardly flowing magnetism. This is the colossal force that maintains the whole Earth-ball in unstable equilibrium and whose revolution in cycloid-spiral-space-curves is caused and sustained by the above rotary (torque-producing) levitating current. By means of magnetolytic dissociative processes, this motion ur-produces the enlivening and originally moving (form-creating) retro-influent energy out of deceased fatty-matter; an energy that gives rise to the hitherto mysterious processes of genesis and increase, and the qualitative improvement (ennoblement) of what has been naturalesquely increased. In other words, it is responsible for the natural self-renewal and evolvment of everything that crawls and flies on this Earth.

Up to now this formative, levitative, multiplying and ennobling natural force has not only been inhibited, but through the reversed form of mass acceleration has been transformed into the decomposive energy-form that destroys development-ripe raw-material. All this happened for the sole reason that air and water were moved axially->radially (= technically, hydraulically or even dynamically) instead of radially->axially, because it was generally believed that the earthly residues of former life decayed to dust and ashes! And so it came to pass that these vital formative substances were thoughtlessly decomposed or combusted in order to produce lower-grade light, temperature and power. In so doing people literally condemned themselves to death by the very sweat of their brows.

The consequences of this defective motion are so great that there is only one thing left to do, namely to reveal the truth with brutal frankness; a truth which, as a Roman poet declared, has been so cleverly concealed that only the sages understood it. Those who think naively, however, continue to go astray. As the mentally castrated so to speak, they do not perceive that they mis-earn their daily bread all the more rapidly by the sweat of their brows, the more conscientiously they carry out the processes and procedures expounded from lecture-chairs and pulpits. They have become the victims of an over-enfeebled mind and only after the most difficult experiences will they be able to re-acquire their innate intuition and repentfully return to Nature.

To put it briefly and simply: We have been taught to wind up the ur-works like a clock, i.e. axially->radially. However, the ur-works that maintain the clock-springs of hunger and love in constant motion must be wound up radially->axially, because only thus is it possible to enable the suctional components to prevail, which produce levitism = upwardly streaming magnetism.

In reality, for the last 2000 years the opposite has happened. Only the Catholic Church, even if merely symbolically, has indicated the naturalesque way to transform matter into spirit. On the other hand, in all areas of the

economy and industry secular science instructed and taught the opposite 'winding'. Therefore, in lieu of the evolution-fostering (ennobling) spirit, it raised and reinforced the demon in the form of development-impeding electricism, as if by conveyor belt, to such an extent that the magnetism-generating Earth, which moves in cycloid-spiral-space-curves, is now incapable of neutralising the decomposive energies and their effects produced by millions upon millions of human beings.

It was therefore inevitable that we should be assailed by the catastrophes of Nature that we are presently experiencing. They are exactly the opposite of those experienced by the Atlanteans, who realised the danger of over-stimulating formative and levitative energies only when whole sections of the Earth were wrenched skywards by these elemental (metaphysical) suctional forces.

All today's machines, all methods of conveyance and the production of light and heat enable the lower-grade heat-, light- and temperature-producing pressured components to prevail and predominate.

Since no heat or kinetic equivalence exist, but only the reactive intensification of development-fostering or development-impeding energies, an economic, social, moral and cultural decline had to take place as the scope of pressure-inducing machines and other such devices increased and intensified.

Accordingly we have to learn the lesson from both extremes and balance out both forms of motion and acceleration in such a way that in accordance with the well-known equation  $F = ma$ , the desired force  $F$  in the form of a predominantly magnetic ion constantly possesses enough levitational superiority to ensure that natural increase and qualitative improvement can keep pace with the unavoidable increase in the population. That is to say, the standard of living must be regulated through the use of higher-grade (quality-increasing) retro-influent dynagens, which come into being when bipolar threshold masses are centripetated in accordance with the equation  $E = mc^2$ . In other words, when they are accelerated by radially->axially in-winding forces to a speed exceeding that of sound under the simultaneous effect of a falling temperature gradient, i.e. accelerated along the longitudinal axis above their boundary velocities. This gives rise to the higher-grade factors of temperature, light and energy out of which upwardly streaming magnetism springs forth from the spiritual embryos, the vitamin-molecules mentioned at the beginning. These are suspended in a delicately balanced state of equilibrium in the media of air and water and await the naturalesque motive impulse in order, as refined subtle matter, to transform themselves into formative, multiplying and ennobling retro-influent energies. This will signify the end of the present shortages of food, raw material, germinating substances and fuels, and instead of capitalism and bolshevism a true socialism will arise about which

Christ preached 2,000 years ago, who taught of the transformation of matter into spirit with the aid of the above form of motion.

## Magnetism = the Function of Levitism and Electricism = the Function of Gravitism

June 1948 (Schauberger Archives)

Magnetism and electricism are the subordinate functions of two metaphysical energetic magnitudes, 'levitism' and 'gravitism' which reign supreme over coming into being and passing away.

These opposing executive forces are to be found in statu nascendi in every solid, liquid and gaseous (air) medium and in the highest-grade transitional state in the vitamin-molecules of the air and water, where they await the liberating motive impulse so as to be transformed into life-affirming magnetic or predominantly life-negating electric fuel concentrates (ions). The forces involved in these metaphysical transformation processes are in the ratio of 96% : 4%. The predominant force in this process can either be the up-building, formative motive force or its decomposive counterpart. Whichever force is subordinate, down to a minimum of 4%, provides the resistance required for all types of motion. Everything is ordered through the agency of 'magnetolytic' or 'electrolytic' processes of dissociation. Both energetic processes are of almost equal value, but differ only in function.

If it has so far been believed that magnetism is a quiescent and more or less passive secondary effect of 'flowing' electricism, this was due to the fact that the type of motion fostering the creation of this higher-grade energy-form was unknown. Equally unknown was the associated shape in which this motion takes place, the so-called 'normal profile'.

Up to now we have therefore been forced to use flowing electricism for the purposes of generating low-grade power, light and temperature (heat). As a result, the essential formative and uplifting force - magnetism - was relegated to the subordinate role of providing the resistance necessary for all motion. That this resistance to motion must increase by the square of the initiating rotational velocity that produces it, is readily understandable because it concerns the development of metaphysical fuels, for which the force of resistance required for the acceleration must increase concurrently and proportionally. For this reason the 'crowning law" (the Conservation of Energy Law) of today's technology is fallacious inasmuch as the supposedly quiescent magnetic resistance to motion can be transformed into a 'flowing' magnetic motive force and conversely, pernicious electricism can be transformed into the aforesaid supportive force (resistance). The means to achieve this is the Repulsator {see figs. 24-26) or the Repulsine (see figs. 30-33), which have hitherto remained unknown.

The decisive factor in the generation of 'flowing magnetism is radial->axial motion and the associated development-facilitating shape. With this it is

possible to split up a tripolar mass (matter) by accelerating it along the longitudinal axis in such a way that, in accordance with the equation  $F$  (force) =  $m$  (mass)  $\times$   $a$  (acceleration), the formative, uplifting fuel-concentrate consisting of ions magnetically surcharged by up to 96% is created. Only by means of this concentrate is it first possible to generate energy in accordance with the equally well-known equation  $E$  (energy) =  $m$  (mass)  $\times$   $c^2$  (speed of light squared), which promotes the naturally ordained processes of formation and higher development.

In this formative process the electrical field-resistance is also responsible for the condensing of the higher-grade medium, which in the process of synthesis described earlier is essential for the physical encasement and insulation of every energy-form. The most important aspect of the magnetolytic (formative) dissociative process is that no low-grade heat-forms should develop during in this restructuring process in which, on the contrary, a cooling (freshening) temperature influence evolves.

This higher-grade dissociative process was previously unknown and therefore the reversed process was used to generate energy. Consequently the relatively most destructive form of energy was produced by very expensive systems of generation and used for the build-up of industry and the economy!!! Precisely the opposite can be achieved through magnetolytic dissociation. The naturalesque process of decomposition is one in which the moved and decomposing matter is cooled all the more rapidly, the greater the rate of acceleration along the longitudinal axis, leading to a corresponding rise in the periodicity of the rhythmical dissociative motion (viz. the rise in periodicity associated with the well-known explosive effect, which produces recoil velocities of up to 5,000 m/sec [16,404 ft/sec])

To be able to appreciate contemporary science's tragic error concerning motion, the following must be stated:

No present-day scientist can explain or understand the quintessential nature of 'motion'. From a naturalesque standpoint, this should be viewed as a rhythmical metabolic interplay between the components of refreshing (cooling) suction and fatiguing (paralysing) pressure; in other words, two constituent forces which as reactive opposites, alternately (rhythmically) act mechanically (materially) and temperature-relatedly (physically). Therefore, depending on the predominance of either the suction or the pressure component (whether the active force is material or physical is unimportant), the metaphysical formative force, or the most elemental destructive force on this planet, comes into being. As the end product of a natural or unnatural sequence of motion, it will be accelerated along either the longitudinal or the transverse axis.

In the naturalesque - formative - direction of acceleration, which must take place along the longitudinal axis (centripetally), so-called electricism acts as

the absolutely indispensable resistance for all motion. As the formative velocity rises, the resistance increases commensurately in order to provide the additional frictional (resisting) surfaces required by the accelerating matter. The actual loss of formative energy associated with this amounts to about 4%, i.e. in this case approximately 96% of the formative energy (= magnetism streaming upwards at enormous speed = levitism) is freed, which sucks up its generating device and a portion of its immediate environs in its wake. In other words, the 'all attracting' comes into being and becomes active with elemental ur-force.

In the unnatural, degenerative direction of acceleration, which operates along the transverse axis (centrifugally), i.e. in an axial->radial mode, the magnetism (= levitism) here acts as the resistance. Compared to the counter-flowing electricism, it appears to be in a certain state of rest, the magnitude of its resistance or support increasing commensurately with the acceleration of the downwardly flowing electricism (= gravitism). This is the origin of the tragic misconception that in all motion the resistance increases by the square of the starting velocity. However, in reality this only happens when any given mass (matter) is made to move technically, hydraulically or dynamically<sup>2</sup>, i.e. axially->radially(centrifugaHy), therefore unnaturally. For if any given mass (matter) is made to move radially->axially (centripetally), then the upwardly flowing magnetism (levitism) increases at the expense of the disintegrative (destructive) electricism (gravitism) and thus the naturally ordained formative and levitative forces intensify in proportion to the starting (radial->axial) rotational velocity. With this type of motion, which is of course only possible with very special motion-inducing shapes (profiles), the effective performance amounts to about 96%. In this case only about 4% of the original formative energies are lost in producing the resistance to motion required by Nature. In technical, hydraulic and dynamic motion precisely the opposite is the case and this is how the enormous consumption of fuel came about, which is exclusively expended in a manner destructive of Nature.

It cannot be disputed that contemporary science, which is founded on far too low a level of basic knowledge, has made exclusive use of pressure-intensifying (development-crippling) motion and arbitrary dynamic shapes that in no way correspond to those required by Nature. The formative components of suctional force, which act in an enlivening (cooling) way, were completely neglected. Hence science created even more dangerous degenerative forces as purported successes were achieved to the detriment of the reactive formative forces. A more rapid economic decline was therefore inevitable, the more widespread and more intensive technology, hydraulics and dynamics became. The soil's energies must also become depleted in the same proportion, because the

<sup>2</sup> These terms Viktor Schaubergger uses disparagingly, for he considered these various scientific disciplines to have misused and misinterpreted Nature's processes. - Ed.

natural structuring forces have begun to dwindle due to contemporary methods of working, motion and acceleration.

In order to round off this understanding, the concept of 'mass' (matter) must also be explained in greater detail. Mass is here to be understood as the product of tripolar motion. It represents the partial solidification, as it were, of a motive force that is latent in a neutral carrier-substance and which to a certain extent acts as the resistance to possible inner motion (vibration).

The interaction - or the inner motion, is only possible by way of the seemingly 'dormant' resistance to motion, whose resisting force also intensifies in proportion to the increase in the speed of the interaction. Were this otherwise, then the greatly amplified product of this interaction could not be concentrated in this atomic prison (lattice) - (viz. the increasingly consolidated resistance to motion associated with physical acceleration, without which the latter could not happen.)

The following is a brief clarification of these internal interactions: If a tripolar mass (plus, minus and neutral) moving in an axial->radial direction is split up by pressure-intensifying and therefore temperature-increasing dynamic influences, then oxygen in a developmentally dangerous form becomes free, unipolar and so aggressive that it consumes (binds) and digests the sweet-matter (carbone), which becomes passive (inactive) under such influences. 'Sweet-matter' is here to be understood as the essential creative (fertile) substance. The end product of this dissociative process is the electrically supercharged ion, whose initial decomposive force can be intensified through high-speed centrifugal axial->radial velocity by up to 96%.

If on the other hand a tripolar mass is split up by suction-intensifying and temperature-reducing dynamic influences, then the true creative substance (sweet matter) will be exposed to revitalising (cooling) temperatures. In this case the formative (levitative) sweet-matter becomes free, unipolar and so highly active that it binds, consumes and digests the oxygen (fertilising substance), which has become passive under this other dynamic influence. The end product of this magnetolytic dissociation is the predominantly magnetically charged ion, whose original formative and levitative force, which as everything else in Nature is to be understood as an indirect effect, can be intensified by up to 96%. Imbued with levitative force, these ions suck up the inferior matter and the generating device in their wake with elemental ur-force and encounter the natural and therefore higher-grade forms of inwardly falling (impanding) and concentrating (condensing) heat and light moving in the opposite direction. The product of this partial concentration, which has been solidified through these higher-grade counter-influences is what is known as 'growth', (see fig. 15)

Mass (matter) is thus a product of precipitation, whose quality increases in step with the essential product of dissociation (the product of the interaction



between two basic substances). This is how the highest-grade element of matter, the floating vitamin-molecule, is created. While it contains too much raw material to be able to float upwards of its own accord (autonomously), it nevertheless does not gravitate, because it is already endowed with strong levitational forces. Indeed in this state, and after the loss of the higher-grade heat- and light-creating forces, it only requires a slight invigorating (cooling) impulse to transform such a mass of ennobled matter into the relatively highest light- and temperature-less state.

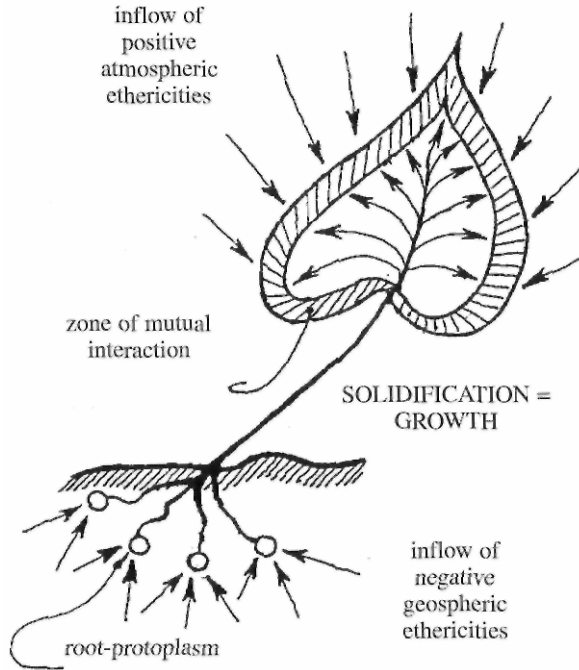

Fig. 15 The manifestation of physical growth

A small, temperature-increasing, material or physical axial->radial impulse suffices to transform such a concentration of highly critical threshold matter in a latent state into the relatively most powerful, destructive energy, whose decomposive force increases in proportion to the strength of the impulse. Thus, for example, a lightning-like recoil in the form of a descending ion is triggered, which with elemental ur-force disintegrates the resistance that brakes its lightning descent.

Contemporary science (technology, hydraulics and dynamics) exclusively and without exception employs the motive impulse which unleashes this

destructive force. That is to say, there is no machine, no transport system, temperature or light generating plant, which does not make use of developmentally dangerous axial->radial impulses. The same applies to all the operational procedures of forestry, agriculture, water and energy supply. All the watercourses and drinking-water plants are being systematically destroyed not only by this development-disrupting motion, which activates electrolytic dissociative processes, but also by official rules and regulations. And if this were not enough, this nation-destroying motion and way of thinking is being enforced by law!

The more strongly the attracting forces become active in the developmental process, the greater the quantity of ennobled magnetolytes (ascended and magnetically supercharged ions) that soar upwards with their adherents and the greater the quantity of less valuable substances expelled by the highest-grade elements which have to solidify under the effect of the counter-influences described earlier. And thus through the proper regulation of these magnetolytic dissociative processes, the increase and qualitative improvement of the aforesaid product of solidification, or growth, can be enhanced at will.

It is hardly worth elaborating further about the opposite case in which the components of pressural force that produce decomposive energies predominate by almost 100%, i.e. the formative (cooling) components of suctional force have been totally disregarded. Therefore with the best will in the world, no flowing magnetism (levitism) can come into being, due to the almost complete lack of the most fundamental prerequisites for growth and increase. On the contrary, everything that now grows (solidifies) already contains the germ of decay, so that in every seed, whether or not it serves an increase in raw or subtle (energetic) matter or even in energy itself, the fiendish demon must rise again.

The decisive factor here is "il primo movere" - the powerful motive impulse of suction or pressure, which will determine the fate of millions upon millions of people.

No scientist can or will dispute the fact that up to now the axial->radial motive impulse, the seed-of-decay-developing impulse, has been exploited everywhere without exclusion or exception. The situation has thus arisen where those forced to work in the wrong way, the enormous host of working people, have had to mis-earn their daily bread by the sweat of their brows. In a manner of speaking, the Devil incarnate has emerged from the seeds of the Spirit, from these mysterious capsules, the vitamin-molecules mentioned at the beginning, and taking these development-ready raw-material concentrates with him, has descended into the depths.

Thus, through a retrogressive impulse at almost the final hour, the most elemental destructive force that ever existed on this fermenting manure-heap was generated from development-ripe matter, as if on a production line. To

put it bluntly, instead of being radially->axially wound up, the ur-works were wound up like a clock-spring in the opposite way, i.e. radially->axially. To date this false 'winding' has been taught and learnt in all schools and preached from all pulpits. Only the Catholic Church, if merely symbolically, has indicated the naturalesque way to transform high-grade matter into Spirit (energy). However they were unable to recognise the truth, because they believed and also fostered the belief, that after death the earthly remains of fatty-matter, out of which allotropic threshold substances - vitamin-molecules - come into being, decay into dust and ashes. Therefore, due to electrolytic processes of decomposition (unnatural form of interment), the metaphysical fat-concentrates cannot come into being, which are the source of spiritual energy that makes all life invincible, free and independent. Perhaps this was considered undesirable so as to ensure the docility of slave-workers by spiritually castrating them through suppression of the build-up of quality substances, thereby making a constant supply of working oxen available.

## 5.

# The Nature of Water, Its Conduction and Use for Transport

"At the intersection of two temperature gradients atomic energy is released. Whether it is a formative or destructive energy is determined in each case by the type of movement and the composition of the alloys used to build the motion-producing machine."

Viktor Schauburger, Implosion Magazine, No. 71, p. 12.

"In the outbirth of water we have to differentiate between two different kinds. Namely water as a carrier-substance that contains predominantly negative potentialities (substances attuned to earth frequencies) or predominantly positive potentialities (substances attuned to air frequencies). The former are to be viewed as upwardly-impelling geospheric instrumentalities and the latter as downwardly-impelling atmospheric instrumentalities. The former refine and exalt the higher-grade constituents, i.e. they serve the build-up of levitative potencies. The latter serve to cleanse the atmosphere of suspended matter, which as threshold substances still possess too little self-weight and too high a quota of levitative essences and can neither rise nor fall. It is these threshold substances that can be transformed and exalted through cycloid-space-curve motion. From a practical point of view, this is only possible through their co-oscillation with their respective carrier-substances, be it air or water. This leads to a build-up of those substances incapable of further development, resulting in a renewed intensification of the differences in potential through the spacial separation of the difference-substances. The end result is an increased motive force. This explains the concept of perpetual motion in its most natural sense."

Viktor Schauburger, Implosion Magazine, No. 118, p. 8.

## Letter to Werner Zimmermann. June 20th 1936

From Spec. Ed. Mensch und Technik, Vol. 2, 1993, section 7.4.

Read "The Ox and the Chamois"<sup>1</sup> again. There you will find precisely the opposite preconditions, namely the release of energy through cold. Here heat

<sup>1</sup> See "The Ox and the Chamois" in Nature as Teacher, p.41, Vol. II of the Ecotechnology series. — Ed.

is first generated through friction. This heat is immediately absorbed by the water and in the process a physical vacuum is created, which then gives rise to the emergence of inner-atomic rays. Due to the absorbed heat, the free, dissolved oxygen still present in the water becomes aggressive and the emergent geospheric rays become aggressive owing to the presence of the vacuum. Through the encounter between the mutually opposed, contra-directionally propagated, excited rays, the precondition for the marriage is created. The child of this union is organic, or cold light.

Good seed in good earth produces a multiple of itself in fruit. The seed grows and its multiplication proceeds with the aid of contra-directional influences. These influences are higher forms of organisation stemming from the Earth and the Cosmos. Substances that are ripe must either fall upwards or downwards. When water is decomposed inner-atomically, then what finally remains is the substance - water, the H-substance<sup>2</sup>. This H-substance is the polarity, which strengthens itself through these influences. It is the ur-child that draws in essences and energies from above and below and in this way it grows.

The plus and minus elements dissociated from the water separate from one another. The small quantities of carbone present in poor quality water make their escape immediately, because they dematerialise themselves. The phos-elements<sup>3</sup> incorporated by the Sun disperse, enter the horizontal potential-field, become highly aggressive, spread themselves over the active substances and await things now imminent. The 'imminent' is a geospheric gas, which is ingested with great cold.

With sudden cooling, carbones become highly aggressive. A marriage between the highly aggressive phos-elements and the equally aggressive C now takes place. The super-potentiated geospheric gas product evolving from this union binds the hydrogen through the emergent inner vacuum and rising rapidly, cools off and lands on an organic anode, whose upper section is extended into a cathode.

By means of mechanical diffusion this transmitter generates a horizontal potential-field and rapidly cools the gas mixture. Having become highly

<sup>2</sup> H-substance: here refers to hydrogen or hydrogen-like substances. — Ed.

<sup>3</sup> Phos-elements: It is not quite clear what is intended here, but it may relate in some way to bioluminescence. However, the following three definitions are provided as an aid to interpretation.

PHOSPHOR: A substance which is capable of luminescence, i.e. storing energy (particularly from ionising radiation) and later releasing it in the form of light. If the energy is released after only a short delay (between  $10^{-10}$  and  $10^{-4}$  seconds) the substance is called a 'scintillator'.

PHOSPHORUS: P. Element. Atomic weight 30.9738. Atomic number 15. Occurs in several allotropic forms, white phosphorus and red phosphorus being the commonest. The former is a waxy white, very inflammable and poisonous solid. Red phosphorus is a non-poisonous, dark red powder, not very inflammable. The element only occurs in the combined state, mainly as calcium phosphate,  $CA^3(PO^4)^2$ . Essential to life; calcium phosphate is the main constituent of animal bones.

PHOSPHATE: Salt of phosphoric acid  $H^3PO^4$ . Phosphates are used as fertilisers to rectify a deficiency of phosphorus in the soil. Note: The editor regrets that he cannot locate the dictionary from which the information was originally sourced.'

aggressive again, as soon as it is expressed this gas will be hungrily absorbed by the surrounding atmospheric oxygen. This O has H and C in tow, which have been drawn along with it due to centripetence. What is important here, is whether this process is permitted to proceed, 1. via warm, or 2., via cold oxidation.

In the first case a surplus of water is produced. In the second case a surplus of air results. In both cases, however, both products have evolved and grown, and hence the product of growth is a multiple of the original seed-form. The better the earth, the stronger the growth and the greater the abundance of the substance.

If air is produced, then water is in the minority. The increase in this case is the air mixture and the 4th dimension that emerges from it - motion as matter. Out of this motion the 5th dimension ultimately comes into being, i.e. the radiant product, the spirit. This spirit can materialise itself. Conversely, a solid, liquid or gaseous substance can of course be spiritualised as well. Whether one desires to produce one or the other intermediate product is merely a question of the dosing of the intermediate process. The dosing of either heat or cold. The organ that comes into being either in this way or the other is a result of the organisation.

Every organ is an aid or a means to an end that requires various supplementary energies in order to evolve. In its highest form, the developed product is a multiple of the ur-form, because the potencies in it have developed themselves. Potencies are nothing more than bipolar tensions, which de-stress one another and synthesise their desired form. This is the reason for the phenomenon of multiplication. The function of tensioning or de-stressing is heat and cold. The product is therefore a product of heat or cold. The impulse is produced by either a cold or warm mediatory process. The place of birth is the egg and the orifice. The fertilised eggs create orifices and conversely, eggs come into being from orifices.

Radiation is the bipolar unity, the ur-information, which metamorphoses itself into proteins. Since information is also bipolar, then the space, the irrtter-space and the shell come into being in this way. The energy evolving within the shell is space-energy, which like everything else is also bipolar. The heat-potential gives birth to the form and the cold-potential gives rise to dematerialisation. The latter is elemental motion and the former is the elemental envelope, that is, the multiplied soul and the multiplied body.

## The Ennoblement of Water

Leonstein, 25th May 1945, Implosion Magazine, No. 124, pp 59-61

Every entity, whether human, animal, plant, mineral or metal, has a very particular characteristic and individual predisposition and therefore a very specific task or life-purpose, which essentially consists in the bequeathal of this special talent for the benefit of an improved further development.

This is especially true of water. It is therefore important to study the nature of water, its inner propensities and its capacity for onward transmission so that general and individual progress can be fostered through the possibility of its ennoblement.

What actually is water? Whence does it come? And where does it go? Countless individuals have already attempted to answer these questions. Not long ago, Professor Gerlach from Munich declared that water was an unfathomable enigma, whose origins and reasons for disappearance remained a mystery.

An old maxim states: "All life springs forth from water." Water is thus the true source of life, which is reason enough for studying it in detail.

Another maxim states: "All life arises from motion." Since it is known that without death there would be no life, there must be two forms of motion. One that produces the life-state and another that creates the preconditions for this to happen. In other words, there must be two completely different types of motion, which function in equally different ways. One of them produces the 'physical' life-state, whereas the other the prerequisites for it<sup>4</sup> by initiating the 'metaphysical' transformation and actuating the processes through which the products of this form of motion can be brought into being.

All birth requires fertilisation. Fertilisation, however, necessitates the disintegration of the original ur-form. All of which brings us to the fundamental question: What actually is motion? This question is answered by a free-falling droplet of water, from which a horizontally and vertically radiating energy-form springs forth, the power of the horizontal emission corresponding to about 12,000 seed-volts as measured with an electrometer. These are referred to as seed-volts here, because in this case we are concerned with a charge-bundle which contains about 12,000 water embryos in an energetic state. These are freed when a drop of water merely falls about 20 cm (8 inches). Naturally, special equipment is required to measure this capacity. To describe it in more detail here, would stray too far from the present theme, therefore clarification of the 'essentials' will have to suffice.

If the horizontally radiating energy-form is conducted into vacuum tubing then on the inner periphery a strongly pulsating, blood-red glow appears. It

<sup>4</sup> Viz. 'motion-of-creation' and 'creation-of-motion'. See footnote 2. - Ed.

this energy-form is conducted into a glass bulb super-saturated with air containing oxygen, then about the same number of water-droplets appear as the seed-volts measured on the electrometer. With this we are already presented with the birth of water and the form of motion that induces it.

The motion of a free-falling water-droplet is characterised by the 'cycloid-space-curve', which the droplet describes as it falls. To describe this form of motion, which gives rise to the metaphysical preconditions for life, in greater detail, which one or two doctors have called the 'life-creating curve', would take too long here. It is therefore here only to be noted that the horizontal emission of dynagens is associated with a spiral configuration of curves, whose transverse radius of action broadens down the longitudinal fall-path.

The vertically propagating energy-form, which in a vacuum-tube produces an intense and dazzling light - or a Sun in statu nascendi as it were - likewise describes a cycloid-space-curve path, but one in which the transverse radius reduces. The faster the water-droplet falls and the higher the vacuum-bulb is positioned on the longitudinal axis, the more dazzling and intense the light becomes. The further the vacuum bulb is removed from the source of the horizontally emitted energy-form, the darker the strongly pulsating blood-red glow becomes. If heavily insulated shields (such as paraffin wax), which have a braking effect, are interposed around this radiant energy-bundle, then under the influence of atmospheric light and heat, positively charged water is produced. However, if the same process is repeated with the exclusion of light and heat, then negatively charged water results.

We are therefore not only faced with the birth of water, but also with the determination of the gender of the birth product. From the sum total of these experiments arose a discovery, whose implications first become evident, when we consider that it opens the way to produce water - the blood of the Earth- in any desired quantity and quality naturalesquely and in addition to pass on the desired properties to the evolutionally-older new-born entity. Water pipelines are therefore no longer necessary in order make what is nothing less than the most noble water available in the middle of treeless deserts or salt-water wastes. This not only ingeniously solves the problem of living space for a constantly increasing population, but also that of food shortages.

Good water - good life: Bad water - bad life; No water - no life. This fundamental axiom, simple as it is true, makes any further comment superfluous. It need only be stated that the water-producing and ennobling apparatus is operational and presently located at Rudolf Zeitlinger's scythe factory.

The possibility for uninterrupted further work is now the only prerequisite for finally solving the core-problem - food shortages. The achievement of this is the task of those who, after Germany's lost war, are now responsible for the further fate of the German people. It is likewise necessary to refine the current attitude of those, who as nature-alienated politicians, are to blame for the



present lot, a situation for which the whole population is also doubtless culpable. Through the free and voluntary disclosure of Nature's greatest secret, this can in part be rectified. For good water into which beneficial properties can be instilled, expiates the crimes of those, who attacked the fate of all humanity in ignorance of the inner nature of the source of life, which can bequeath both good and bad character traits.

## The Transport of Ore in Double-Spiral-Flow Pipes

Vienna, July 1939 (Schauberger Archives)

In 1933 a proposal was presented to the Alpine-Montan company stating that the ore from iron ore deposits could be delivered to Donawitz, not at the current price of about 3.50 schillings per tonne by rail, but at a cost of about 0.30 schillings per tonne by means of a patented double-spiral-flow pipe (see fig. 16<sup>5</sup>).

At first this proposal was ridiculed, because according to expert opinion either the ore, having a specific weight of 1.9 and therefore heavier than water (= 1.0), would be left lying on the bottom or the pipe-walls would be heavily scoured within a short space of time, and therefore the proposal would not be commercially viable.

In order to counter these opposing views practically, test pipes 64 metres long with an internal diameter of 27.5 cm (11 inches) were fabricated. At a gradient of 1%, ore and pebbles with a grain-size of about 10 cm (4 inches) in cross-section were transported down the pipe. The experiments were carried out at Kohlleben. The steeper the geological gradient was, the more efficacious the transport.

The experts from Alpine-Montan and the then Ministry of Agriculture were forced to admit that ore, stones, mineral coal - in short, bodies heavier than water, were in fact transported down the flow-axis of the pipe without touching the walls.

The speed of the ore, which moved silently along the pipe-axis, was so great that the passage of lumps of ore larger than fist-size could not even be observed in the crystal-clear water through the observation windows. Even at the point of discharge, the speed was too great to be able to discern the stones, etc.

In order to ascertain the uninhibited motion of the transported material, small wire baskets were placed at the end of the pipe in order to determine the flow velocity and the actual position and motion of the heavy bodies down the axis of the pipe.

<sup>5</sup>See also figs. 8 & 9 and associated patent descriptions in *The Water Wizard*, Vol I of the Ecotechnology series. — Ed.

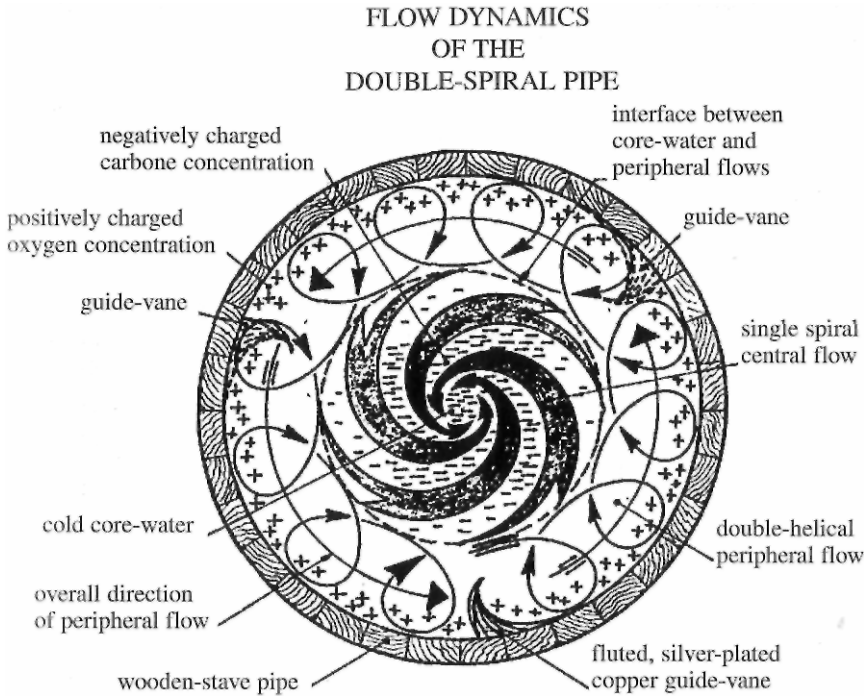

Fig. 16: Pipe cross-section showing double spiral flows<sup>6</sup>

After this practical demonstration, it was announced that the quantity of ore available for transport was falling by the month and that it would no longer be profitable to build a second such pipe-line alongside the existing railway, because it might be necessary to shut down the blast-furnaces altogether and to close the business temporarily.

The whole affair was no longer pursued owing to the deteriorating economic situation.

<sup>6</sup> In regard to the carrying capacity of wooden pipes, the following passage from a book 'The Australian Wood Pipe Company' (p. 21, publ. circa 1910) provides interesting insights. "It is conceded that smoothly-planed timber has the lowest coefficient of friction of all materials ordinarily employed for conveying water. Many extensive experiments have been made on the flow of water in various kinds of pipe operating under many conditions. Within the last few years, the United States Department of Agriculture has carried on a very extensive series of experiments on the flow of water in Wood-Stave Pipe, and attention is called to their Bulletin No. 376, and in particular to the conclusions therein: Conclusions. 'That the data now existing does not show that the Capacity of Wood-Stave pipe either increases or decreases with age. That wood pipe will convey about 15 per cent more water than a ten-year-old cast iron pipe or a new riveted pipe, and about 25 per cent more than a cast iron pipe 20 years old, or a riveted pipe ten years old.' The conclusion of Government experiments, as given above, definitely prove that the carrying capacity of Wood-Stave Pipe is from 15 percent to 25 per cent greater than metal pipe, with the additional advantage that Wood-Stave Pipe will remain smooth and clean internally throughout its entire life."- Ed.

Since interest in this ore-transport has now been revived by a third party, the following description of the method of transporting bodies heavier than water, which contradicts known scientific opinion, is still relevant.

It is known that a few rivers not only transport their heavy sediment to the sea, but despite the resistance of the heavy sea-water, actually carry it far out and form promontories (haff formation).

Rivers that warm up along their course, deposit their sediment, silt up the channel and form deltas, so that instead of the formation of new dry land, marsh- and swampland have created.

The secret of the dwindling and disappearance of the tractive force and carrying capacity in a naturally flowing stream lies in the way it moves.

The origins of all motion are differences in potential. If these differences cannot be maintained during flow, the water's kinetic energy wanes and the sediment is deposited in the wrong place. New bends are formed in this way, which have a greater significance than has hitherto been assumed.

The river-bend or curve is the cradle of water. Due to the water's swaying and swirling motion, processes of atomic transformation take place within the inner structure of the water, which have escaped the notice of the world of experts.

The straightening of a watercourse in order to shorten it and steepen the geological gradient results in an even stronger deposition of sediment and even greater flattening of the geological gradient, a widening of the channel, the warming of the water and its even more rapid disappearance.<sup>7</sup>

The amount of energy lost when a river discharging about 500 m<sup>3</sup>/sec is warmed to about +22°C (+72°F) amounts to about 45 million kilowatts or 57 million horsepower per second.

This energy loss should be viewed as a form of latent energy, which is lost with a dynamic form of motion, but can be gained by a bio-dynamic form<sup>8</sup>, for which experimental proof is available.

The energy that can be gained through bio-dynamic motion manifests itself in an increase in tractive force and carrying capacity, which appear primarily in the pipe-axis. Here the water is densified inhomogenously, because its contained gases are transformed into non-spacial dynagens.<sup>9</sup> As a result the core-water surges ahead like a ball of energy with increasing velocity.

Dynamically conducted water, on the other hand, generates motion-impeding gases.

<sup>7</sup>This is due to the abnormal evaporation rate caused by extended surface exposure and excessive infiltration into the ground due to the downward displacement of the +4°C (+39.2°F) anomaly zone. — Ed.

<sup>8</sup>Dynamic — Bio-dynamic: Here Viktor Schaubberger differentiates between conventional hydraulics and naturalesque water flows. — Ed.

<sup>9</sup>Inhomogenously: Since some of the water's gases are transformed into a non-spacial state through densation and the remaining water is densified through cooling, two different states of densation exist and therefore the water is densified inhomogenously. Similarly, despite the overall cooling of the water, the peripheral flow are always warmer than the central core. - Ed.

In patented double-spiral-flow pipes the peripheral water-masses are caused to swirl within and about themselves and around the central pipe-axis. This produces differences in potential between the peripheral and core waters, which lead to an accelerated flow resulting from the energising and ennobling of the bio-dynamically moved water.

The bio-dynamic movement of water is thus the form of motion that leads to culture per se or the inner culture of the water.

If the concept of 'culture' were to be defined naturalesquely then it should be interpreted as "the protection of Nature's pre-acting fundamental processes". This is only possible by taking care of what it is that is moved, for as mentioned earlier, naturalesque motion leads to the vivification of the life-carrier - water - and unnatural motion to its mortification, or its death and disappearance.

The open secret of water consists in the fact that processes of organic synthesis take place in the naturalesque conduction of water, whereas processes of organic analysis occur when it is conducted unnaturally. In the former case, the growth of water and an increase in latent energy occurs, hence a qualitative improvement. In the latter case, it results in the disappearance of water, to losses in latent energy and logically to a decline in quality.

It would deviate too far from the theme at hand to elaborate the inner processes of motion of naturally or unnaturally conducted water in greater detail. It is worth mentioning briefly, however, that the water discharged from such an ore transportation system is the most ideal regulator of the downstream flow regime of a river below it, because the enormous energies generated through double-spiral conduction restore the river's kinetic energies, which to a certain extent were lost through its unnatural regulation. Compared with current methods of transporting the present 3 million tonnes of ore by rail, not only can 9 million Marks be saved, but the large rivers can be reinvigorated at the same time, thus becoming dynamic, fresh and healthy through an unimaginable boost of energy from the double-spiral-flow pipe installation. Fresh and healthy water is the first priority for the culture of any country.

## The Liquefaction of Coal by Means of Cold Flows

Vienna, May 1941, Implosion Magazine, No. 121, pp 37-47

It is a known fact that there are infertile humans, animals unable to reproduce and plants incapable of propagation. This is usually ascribed to an organic defect, but can also happen when any old donkey interferes with the normal course of development. Or it might even be a unique phenomenon.

Infertility or inability to reproduce, however, is not merely limited to increase in a purely quantitative sense; it can also be of a purely intellectual

nature. People who are mentally limited or who have no natural creative ability as a rule are said to be bird-brained. This is a bird, however, that can grow into a veritable bird of prey, which here is to be interpreted as mindless greed, idiocy or other similar traits.

To the latter breed belong those, for example, who bore holes into the organism - Earth - in order to obtain oil, which they then distil so as to make use of the distilled product, petrol (gasoline) to fuel conveyances on land, water and in the air.

Crude oils belong to the genus of physical manifestations that are incapable of reproduction. They are formations that missed their way on evolution's developmental path and rightly belong to the genus of mules, in which connection the donkey is also known to have made a mess of the normal progress of development. Seen from this angle, distilled crude oil is to be considered as a kind of super-mule, produced by humans who think they can cleverly outsmart Nature.

Apart from those who are happy to extract Nature's failed products such as oil, directly from the ground, there are others who make it their life's work, so to speak, to earn their living by meddling in wise Nature's affairs. These species of human being are commonly called chemists, who are known to produce products of fermentation without taking Nature's dynamic processes into account. Without this there is no possibility for reproduction and further development of any kind, because things possessing these properties have come into being through movement, during which differences in temperature arise that initiate intermediate metabolic processes. These then give rise to flow-alternating processes that engender products of organic synthesis, which is what concerns us here.

The last paragraph is already rather difficult to understand, because today nobody knows the true meaning of the expression 'product of organic synthesis'. Such a person is therefore unable to understand that here too, as elsewhere, differences also exist.

Differences are very noteworthy things, and for this reason: Without differences in charge or potential, for example, there would be no motion of any kind, and therefore in terms of the above interpretation, there would be no reproduction or further development; in a word, there would be no evolution.

Conversely, this means that the generation or ur-procreation of natural-*esque* differences actuates natural-*esque* forms of motion through which, for example, 'evolution' can be formed and fashioned in countless ways.

At this point the creation or ur-generation of natural-*esque* potential differences should be examined in more detail in order to wr-create the driving forces and propellants, which neither burn, nor stink or make a loud noise.

That life is a battle is beyond dispute. Men are also inveterate fighters, who believe they can dupe wise Nature and thereby rank themselves amongst the

most cunning. If one looks at the matter very closely, however, they are actually poor wretches, who put their existence, their heads and their necessities for life at risk, because it is dangerous, particularly in time of war, to attempt to lead persons in authority around by the nose.

After this introduction we shall now attempt to describe the enormous difference between differences in potential in the only way possible for an unscientific observer of Nature.

There are two observations that afford an insight into natural processes, which if taken to their proper conclusion, open up unimaginable possibilities.

1. It is a known fact that in high-pressure boilers a reflux from high to medium pressure takes place under certain circumstances without the hermetic seal being broken<sup>10</sup>. Up to now this occurrence could not be explained and because of it the manufacture of miniature pressurised boilers was abandoned, which meant, of course, that veritable mechanical monsters had to be put up with, which consumed a great deal of space and material.
2. It is also known that minute bubbles of carbon-dioxide (carbonic acid gas) appear in good high-spring water, if the water is exposed to the influence of light and heat. If the water is again cooled under the exclusion of light, then the bubbles disappear. The crystal-clear water, however, tastes empty and insipid even when cool. Its former full-bodied wholesomeness has therefore vanished without trace.

A third case will be mentioned here, albeit briefly. If under very particular external influences good high-spring water is rotated at high speed in turbines with blades inclined at a certain angle, then on occasion the effective force rises exceptionally high; by calculation to peak pressures of about 32,000 atmospheres, leading to corrosive damage to the turbine blades. More detailed elaboration would take too long here, and therefore it should be enough to point out that these three phenomena are known facts.

<sup>10</sup> The following excerpt from "Pregnant Water" (Schwangeres Wasser) in Implosion Magazine, No. 117, pp. 60-61, explains this process: "It is a known fact that no free oxygen is present at normal temperatures, but that in the form of ozone it is loosely bound to nitrogen in the ratio of  $3O^2$  to  $6N^6$ . Were it otherwise, then it would not be beneficial to living things. It is only at  $+40^\circ C$  ( $+104^\circ F$ ) that the individual  $O^2$  molecules appear, which trigger life-threatening chemical reactions in the human body and are the cause of heat-stroke for example. At about  $1,000^\circ C$  ( $1,832^\circ F$ ) single-atom molecules of  $O$ , identical to the oxygen atom, appear, which naturally have very specific effects. This is why, despite the hermetic seal, the high pressure in high-pressure boilers drops to medium pressure once the above atomic transformation has taken place. Similarly, it is a fact that  $N$  (= nitrogen) is not a uniform basic element, but in reality is  $CH^2$ , i.e. a carbene composed of  $He^3$  (helium), wherein two atoms of hydrogen play the role of carrier-substance as it were. Furthermore, it is known that gaseous water and liquid water are quite different things. Gaseous water is  $OH^2$  and liquid water  $(OH^2)^6$ . The strong action of gaseous water, for example, follows from this, because two free action quantities or points become active, whereas liquid water has no action quantities, because all the action points are filled with H." Viktor Schaubberger. - Ed.

What science cannot measure or weigh exactly, exists just as little as what the farmer cannot grasp, see or feel.

Because of this curious attitude, conventional science has made a serious mistake, which we have to thank for the general economic decline, the world-wide unease and unrest, and not least, the constant wars. As long as this mistake remains uncorrected, any lasting peace is unthinkable, for owing to the serious disruption of natural development, the quality of the soil is declining, the shortage in raw materials is increasing and the various sources of food and fodder are dwindling in the same ratio that the population is increasing. It is therefore obvious that under such circumstances no lasting peace can come about.

Viewed from a naturalesque standpoint, evolution or reproduction and further development should be seen as a sexual process. Only thus can the truth be established and practical progress made.

Truth is an approach towards probability. The closer we come to the truth, the more bitter the realisation that today's science is a fallacy with serious consequences, because it operates with values that are no values, but utter worthlessnesses.

Nature is careful and operates with real values, and the more valuable they are, the less they manifest themselves.

Let us consider, for example, a fully-developed ovum in the body of a fertile woman. The reproductive product, the child, can only be woken to life through a particular forward motion, which takes place first. This leads to the influx of the fertilising substance, to independent life and thus to autonomous movement. For this process wise Nature made provision for certain changes in shape associated with aroused or excited states without which the coming to life of a child is impossible.

The actual formative instrumentalities are always present and only come into play under very particular preconditions. Any human with the organic capacity can make use of one or the other attribute in order to beget the 'crown of creation', a young child for example, provided he or she is at all capable of becoming aroused and surrender themselves to the particular motion ordained by Nature for reproduction and further development.

We have to follow precisely the same *modus operandi* if we wish to reproduce or further develop a given water, so as to ur-produce qualities and properties that can be applied to the widest variety of purposes. Naturally the same is true for other organisms, amongst which air is also to be included.

These two organisms (air and water) contain various ingredients that differ both in nature and kind. It is common knowledge that science regards these interstitial substances as the impurities of a substance, which it considers to be just as chemically inert as it does the carrier-substance itself.

These supposed impurities are the carriers of bipolar energetic factors, which in their interaction with other factors in their environs manifest themselves as reproduced and evolved ethericities. These always appear as

individualities and while similarities occur, identicalities never do. This fact alone suffices to show that any rigid conformity to law or dogma-derived process is just as impossible as an identically formed product, for the form and type of the product of synthesis is determined by a process of constantly changing change. It was Heraclitus, who long ago stated that one cannot bathe in the same water twice, because it is in continual motion even when apparently still, and is thus in a constant state of metamorphosis.

What could be more desirable than to move water or air in such a way naturalesquely that the beneficial and valuable inner factors attain their relatively highest state as ethericities, which on their part lead to the most beneficial processes of reproduction and further development.

In order to clarify what has been stated in the last paragraph, books would need to be written. Here we are especially concerned with the production or ur-creation of higher formative and dynamic agencies (dynagens), whose essential nature will be described here to the extent necessary to enable miniature machines to function more naturalesquely and therefore better than is presently the case. Everyone has a free choice either to adopt these new methods or to continue to believe that the scientific system, devised by rationally-minded individuals, is the very last word in mechanical motion.

The practical aim of this explanation is the production or ur-creation of a hydrocarbon that neither burns, nor smells or makes noise, the essential point here being that it is of a much higher grade and therefore functions far more efficiently as a propellant than oil, which has been cleverly manipulated, or the synthesised product that the chemist calls synthetic petrol (gasoline).

Everyone knows that so-called petrol (gasoline) is an explosive substance. That the creation of precisely the opposite is what is intended here, stems from the fact that we wish to proceed im-scientifically. With this tm-scientific product of synthesis we are therefore concerned with no ex-plosive product, but only with an im-plosive factor.

If we study the inner processes involved in synthetic fuel production, then we can establish that, together with supplementary catalytic factors, strong pressure and high temperature play the leading role.

Just a small heat-influence is enough to separate the higher factors from more inferior ones contained in good water. As the condensing reversinary elements of retro-development, the latter appear and become visible in the form of substantial physical matter. It should therefore be quite obvious that with the high temperatures known to be necessary for contemporary methods of coal liquefaction, the identical processes of separation and concentration must take place in increased measure.

At this point it should be noted that this always involves a law of reciprocity, or that the bipolar basic substances are inversely related both symmetrically and proportionally.



The inner ingredients contained in carbon (carbone) can be compared to the unfertilised reproductive or formative substances of a mature woman immediately after menstruation.

Like the beads of carbon-dioxide in water that has been warmed, through the strong influence of heat the residual substances shrivel up after the separation and precipitation of the higher quality constituents<sup>11</sup>. Due to the high pressure the outer envelope or the carrier substance will be crushed and in this way the de-energised elements released.

The opposite primary elements, the varieties of so-called oxygen, will be physically released at higher temperatures, i.e. they attain the so-called charged state that enables them to consume, or as the scientist says, to bind their as it were 'devoted' condensed counterparts.

Through this metabolic process a transformation takes place that ultimately gives rise to a motion leading to a higher and a lower product of synthesis. This further results in two different current flows and the products associated with them. In the first case, this logically leads to the formation of a higher energy-form, which pierces through any enclosing walls and expresses itself as an emitted charge.

In the second case, a marriage takes place between the residual substances. In short, the inferior product of synthesis that science calls synthetic petrol (gasoline) is produced. The moment this second, inferior synthesising process happens, a pressure recoil (cavitation) takes place due to the emission or discharge of the higher constituents (viz. the pressure reflux in high-pressure boilers).

Further examination of this uninteresting process will be discontinued here, because the naturalesque and hitherto entirely unknown process is far more interesting than this scientific derailment of natural processes.

When two people do the same thing, it is never exactly the same, and all the more so, if something is initiated under completely different preconditions, which is here the case in a practical sense.

The two bipolar inner constituents, which appear in a nascent state in every organic substance, should be viewed as latent energy-compounds, which require appropriate prior preparation in order to be combined (married) naturalesquely. As a result a product of synthesis is produced that is substantially different from what science describes as 'synthetic petrol (gasoline)'.

In a pipe, which is described in greater detail in the patent application to the Reich's patent office<sup>12</sup>, specially shaped resistance-inducing vanes are incorporated, which are made of a potential-increasing material and are installed and aligned along very particular curved paths on the inner periphery of the

<sup>11</sup> In the conversion of carbonic acid ( $\text{H}^2\text{CO}^3$ ) to carbon dioxide or carbonic acid gas ( $\text{CO}_2$ ) with heat, molecular hydrogen ( $\text{H}^2$ ) is released. Therefore a kind of vacuity is created, causing a reduction in the inner 'volume'. — Ed.

<sup>12</sup> See descriptions of Patent Nos. 134543 and 138296 (pp. 201-203) and associated figures Nos. 8 & 9, p.63 in *The Water Wizard*, Vol. I of the Ecotechnology series. - Ed.

pipe-walls. The patent extension for constructing these vanes is included with the patent application under separate cover. In the patent claims particular reference is made to the pipe's insulation. Details of the angular configuration, etc. of the above vanes were omitted, because they have already been included in earlier patents.

Details concerning the initial procedures for catalysis and catalytic effects appear in the application only to the extent necessary for the preliminary establishment of the novelty and the technical feasibility of this pioneering patent. It is not the examiner's brief to adjudicate on the practicality and other aspects (see patent regulations) of the application and therefore nothing has been excluded that is required or prescribed for the patent examination. It should be emphasised here that the mechanical processes in this pipe are totally uninteresting and therefore my own earlier applications and those of others, which give prominence to the advantages of the mechanical motion, are peripheral to the present application.

This pipe should be laid to a particular gradient and oriented in certain direction<sup>13</sup>. It should then be charged with water - the best kind being sea-water thoroughly irradiated by the Sun - to which coal dust, carbonic acid and other things have been added.

Together with its ingredients, the onrushing water proceeds along two completely different paths. The peripheral water-masses follow a centrifugal developmental path, while the core water-masses take a centripetal one.

Bodies heavier than water move down the centre. Bodies lighter than the carrier-substance migrate towards the periphery, where they are thrust against the wedge-shaped guide-vanes, which deflect them towards the pipe-walls<sup>14</sup>. These guide-vanes are placed at certain intervals so that mechanical pressure is alternately increased and decreased continuously. This results in the cooling of the whole water-mass, similar to the Linde process<sup>15</sup>, only that here

<sup>13</sup> See description of the north-south and west-east orientation of pipes on p. 175 of *Nature as Teacher*, Vol. II and in "Increase In Soil Productivity", in *The Fertile Earth*, Vol. III of the *Ecotechnology series*. — Ed.

<sup>14</sup> See explanatory figures Nos. 10 & 11 on p.4 of *The Water Wizard*, Vol. I of the *Ecotechnology series*. — Ed.

<sup>15</sup> Linde process: (1) "A high-pressure process for the production of liquid oxygen and nitrogen by compression to about 200 bar (20 MN/m<sup>2</sup>) followed by refrigeration and fractionation in a double column. - Penguin Dictionary of Chemistry, Penguin Books, Great Britain, 1983, p.399).  
 (2) "A process for the liquefaction of gases by the Joule-Thompson effect. In this process devised by Carl von Linde (1842-1934) for liquefying air, the air is freed of carbon dioxide and water and compressed to 150 atmospheres. The compressed gas is passed through a copper coil to an expansion nozzle within a Dewar flask. The emerging air is cooled by the Joule-Thompson effect as it expands and then passes back within a second copper coil that surrounds the first coil. Thus the expanded gas cools the incoming gas in a process that is said to be regenerative. Eventually the air is reduced to its critical temperature and, at the pressure of 150 atmospheres (well above its critical pressure), liquefies. The process is used for other gases, especially hydrogen and helium. Hydrogen has first to be cooled below its inversion temperature (see Joule-Thompson effect) using liquid air; helium has first to be cooled below its inversion temperature using liquid hydrogen." (*Collins Dictionary of Science*. Oxford University Press, Great Britain, 1984, ISBN 0-19-211593-6). — Ed

the arrangement is substantially different from all other known cooling processes.

Through the indirectly engendered cooling the density increases, whereby the frictional pressure is intensified by the mechanically-induced increase in velocity. The arrangement of the guide-vanes causes a spiral circumvolution, so that the bipolar ingredients, which rub against one another flow all the faster as their volume is reduced by the constant abrasion. Apart from the circumfluent motion another form of motion is also active which causes the bodies of the ingredients to swirl about their own axes and ensures their abrasion on all sides.

Here it should be noted that experiments established that all substances of terrestrial origin<sup>16</sup> react to centrifugence, whereas the higher refluxent or inward-falling substances, namely all forms of so-called oxygen, react to centripetence.

This results in the spacial separation of the two bipolar substances, i.e. the oxygen proceeds down the centre and the carbonates along the sides, where with increasing slip-pressure against the resistances (guide-vanes) and rotating about their own axes, they continue to be ground off. As a result the inner constituents are freed and separated out according to their centrifugal or centripetal characteristics.

We therefore arrive at the following transformative phenomena:

1. The inner constituents freed through mechanical abrasion (removal of the outer envelope) are transferred into two different states due to the cooling of the carrier substance. Through this increasing cooling the terrestrial substances or carbonates attain their relatively highest potential.
2. The stocks of all forms of so-called oxygen travel down the middle and with increasing cooling become inactive and shrivel up like their counterparts, the beads of carbon-dioxide in warmed water. At the same time these increasingly indifferent<sup>17</sup> fertilising substances (oxygen) are accelerated mechanically along the unrestricted (no guide-vanes) and shorter central axial path and are thereby dispersed, or dosed as it were. (see fig. 16)
3. Through the rising acceleration of the axially moving core-water-masses, the centrifugence of the swirling peripheral water-masses intensifies. This in turn increases the slip-pressure exerted by the suspended ingredients on the naturally shaped and alloyed potential-increasing slip-resistances (guide-vanes). Due to the rising velocities the oligodynamic effect also increases, i.e. more and more supplementary influences are freed by the potential-intensifying frictional resistances and due to the water's careful

<sup>16</sup> Terrestrial: In relation to oxygen, which Viktor Schauberger viewed as a lower form of sunlight, this refers to substances that specifically belong to the Earth (carbonates). - Ed.

<sup>17</sup> indifferent: relates in this instance to a condition similar to lethargy. - Ed.

insulation against heat are bound into the water, which is swirled in towards the central axis by the inclined angle of the resistances - guide-vanes. 4. Having been drawn there by the increase in axial velocity, the water-masses inwinding towards the central axis now bind the highly active dynagens, which have been released through the mutual abrasion of the carbones. No longer reacting to any mechanical centrifugence, these energised terrestrial elements then begin to encircle the centrally moving oxygenes. Through the continuous approach of the through-flowing water-masses towards the anomaly point of  $+4^{\circ}\text{C}$  ( $+39.2^{\circ}\text{F}$ ), on the one hand the terrestrial elements attain their relatively highest energetic state and on the other, the oxygenes become increasingly indifferent and more dispersed, thus reaching the condition proper to a fertilising substance. If this state is reached at the anomaly point, then the highly energised terrestrial residues (the former carbones) bind their fertilising counterparts, and the naturalesque product of synthesis is complete.

This product of synthesis is characterised by the fact that the ratio between oxygen and its carbone counterpart is 4% : 96%, because all the remaining oxygen has been transformed into fertilising substances and then bound. Therefore the new product of synthesis has the highest negative valency and is of geospheric character. Certain factors relating to these processes should be noted: In the scientific synthesising process heat has a shrivelling effect on the decisive formative substance in its nascent state, while physical pressure ruptures its outer envelope. In the case of coal liquefaction by means of cold flows the increasing cooling on the developmental path acts to increase the potential. However, since the increase in the potential of the true formative substance is of a purely energetic nature, it would be unable to break through the outer envelope had this not been mechanically abraded through the circumvolution and inner rotation (about itself and its own axis) caused by the increasing frictional pressure arising from the doubly increased velocity of the whole water-body. These differences demand the closest attention and consideration. The product of synthesis obtained by means of cold flows, binds itself into its own waste product (juvenile water). Therefore apart from a new, fresh and more highly cultured energy, an associated carrier-substance of the highest order is also created at the expense of the gradually transforming (internally reconstituted) stocks of old water. This two-fold transformation represents the increase and the qualitative improvement of what has been quantitatively increased (the growth of water). The finished product is a crystal-clear water that has neither taste, nor smell, nor colour, because in this product of synthesis all kinds of things are on the loose or have been loosed (emancipated), i.e. they have been raised to the

relatively highest evolved state, which is of energetic nature and therefore non-spacial. This water has the relatively highest density and specific gravity, attained through cooling towards the anomaly point, which is marginally less than  $+4^{\circ}\text{C}$  ( $+39.2^{\circ}\text{F}$ )<sup>18</sup>.

If this product of synthesis, almost exclusively composed of geospheric energies, is atomised and atmospheric oxygen simultaneously infused through nozzles (viz. other forms of fertilisation), thus charging it with fertilising substances (these become passive at high centripetal velocity) and if this whole mixture is lightly compressed (warmed) by a descending piston, then the mixture is instantaneously transformed into the next higher state of development or aggregation, namely into air.

Due to this new organism's roughly 1,700-fold increase in volume, an exploitable expansive pressure equal to about 2,000 atmospheres per litre (0.264 gal.<sup>19</sup>) of such water is produced.<sup>20</sup>

That this tremendous pressure expresses itself silently requires no special comment. That, as a high-grade air, this product of transformation has a more beneficial effect on the environment and development generally than the waste matter of explosive processes, also goes without saying. That this high-grade product of transformed air does not smell, is without doubt. In this way what was striven for has been achieved, namely a far higher exploitable pressure than is produced by any form of petrol (gasoline). Moreover, it is an incombustible pressure-creating substance that neither stinks nor creates a din, and its beneficial effect can be raised to any desired level, so that in practice the smallest quantities are enough to achieve any desired effects.

This ideal pressure-producing substance is the driving medium for powering the centrifugal Repulsators, which ur-generate the bio-electromagnetic vacuum, the most powerful suctional force of Nature's that could ever be imagined. These centrifugal Repulsators are described in the patent application at the Reich's Patent Office in Berlin<sup>21</sup>. Their more detailed description will be undertaken at an appropriate moment in the future.

## Patent for: Pipe for Liquid and Gaseous Media

### AUSTRIAN PATENT OFFICE

### DESCRIPTION OF PATENT No. 196680

<sup>18</sup> Actually  $+3.98^{\circ}\text{C}$  ( $+39.164^{\circ}\text{F}$ ). — Ed.

<sup>19</sup> Gallons: Where values in gallons (gal) are referred to in the text, these are US gallons, where 1 US gallon = 3.785 litres, or 1 litre = 0.264 gallons. — Ed.

<sup>20</sup> "At a temperature of  $15^{\circ}\text{C}$  water is 819 times heavier than air at the same temperature. Water-vapour, on the other hand, absorbs a 1,700-fold volume of water. With the evaporation of 1 litre of water, about 600 heat units become latent (stored, bound)." Walter Schauburger, *Implosion Magazine*, No 9, p.26. — Ed.

<sup>21</sup> Unfortunately no details of this patent are available. - Ed

Class 47 f, 1

Issued 25th March 1958.

## VIKTOR SCHAUBERGER IN LINZ

## PIPE FOR LIQUID AND GASEOUS MEDIA

Application date: 30th May 1951 - Patent applies from: 15th August 1957

The named Co-inventor is Dipl. Ing. Walter Schauburger of Lauffen (Upper Austria)

Many suggestions have already been made as to how losses in energy, pressure or velocity arising in the transport of liquids or gaseous media can be reduced. Thus for the purposes of inhibiting the formation of air-bubbles, which provoke an increase in the resistance to flow, a British Patent No. 409,528 for a pipe has been published, which is wound in a screw-form manner and its cross-sectional surfaces are formed by two arcs of a circle. From the British Patent No. 28,5343 of 1913 AD, the application of a pipe with an egg-shaped cross-section was made known, which was provided with flow-directing slats to inhibit the formation of vortices. In the U.S. Patent No. 1,655,197 as well as in the Swiss Patent No. 126637, cylindrical or conical pipes were proposed with the object of reducing friction by converting it into rotation, for which the pipe axis served as the rotational axis. Lastly, the Austrian Patent No. 28099 depicts the use of indented and twisted pipes.

This invention (see fig. 17) relates to a conduit or pipe for liquid or gaseous media, which is intended to prevent encrustation and to reduce flow losses, wherein the pipe cross-section is formed of several curved arcs of a circle and the pipe is coiled in a screw-form manner. The invention also consists in the fact that the cross-section is egg-shaped with an indentation on one side adjacent to the pointed end of the egg and that the pipe is first twisted upon itself before the whole is formed into a coil. With the aid of such a pipe, the conveying capacity and efficiency is improved due the reduction of frictional losses and the prevention of encrustation. In order to increase the conveying capacity, the coiling of the pipe around an imaginary cylinder has proved to be particularly effective. For the same reason, the pipe can be rotated in a normal manner, whereby the central axis of the coiled pipe arrangement is also the axis of rotation. It is also advantageous to narrow the cross-section of the twisted pipe.

In the attached drawing the cross-sectional form and the coiling of the pipe are depicted schematically. Figure 1 shows the cross-section of the pipe and Figures 2-4 the pipe in its coiled configuration.

In Figure 1 the cross-section of the pipe in question is shown with a curved indentation on one side adjacent to the smaller end of the egg-shape. The coiling of the pipe can be effected by winding it round an imaginary cylinder,

Figure 2, or around an imaginary cone, Figures 3 & 4, prior to which the pipe is first twisted about itself. If the pipe is wound around an imaginary, circular cone corresponding to Figures 3 & 4, then pipe cross-section can be narrowed either towards the point or towards the base of the cone. Furthermore, for purposes of reducing frictional losses and the avoidance of encrustation, the whole arrangement can be rotated by suitable means, wherein the central axis of the coiled arrangement is also the axis of rotation.

### Patent Claims

1. The invention of a pipe for liquid and gaseous media for the prevention of encrustation and the reduction of flow losses, whereby the pipe cross-section consists of several arcs of a circle and the pipe is wound in a screw-form shape, is characterised by the fact that the cross-section of the pipe is egg-shaped with a curved indentation on one side adjacent to the pointed end, and that before being coiled, the pipe itself is first twisted.
2. In accordance with Claim 1, the pipe is characterised by being wound around an imaginary cone.
3. In accordance with Claims 1 & 2, the pipe is characterised by the fact that the coiled arrangement as a whole can be rotated about the central axis of the same.
4. In accordance with Claims 1 to 3, the invention is characterised by the fact that the pipe cross-section narrows in one direction.

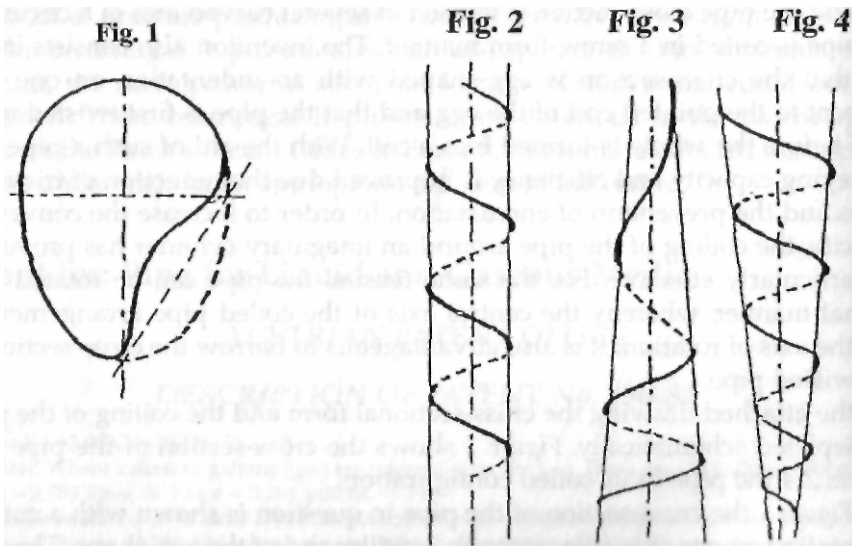

Fig. 17: Double spiral pipe diagram - patent No. 196680

## Patent for: Processes and Equipment for the Conveyance of Liquid, Gaseous or Aeriform Media

Processes and equipment for the conveyance of liquid, gaseous or aeriform media, as well as for the control of molecular separation and reduction, transformation and synthesis in moving media and the achievement of increased mechanical power

### VIKTOR SCHAUBERGER PATENTS - 1953

(The following text has been compiled by the editor from Implosion Magazine No. 41 and the Patent documents listed below.)

Portugal: No. 29,729 - 1953 - France : No. 1.057.576 - 1953 - Brazil: No. 43,431 -1953

This invention (see fig. 18) relates to a process for the conveyance of media in a liquid, vaporous, gaseous or aeriform state and which can be described, for example, as emulsions or suspensions, etc. Moreover, it also relates to the equipment required to carry out such processes. The invention also concerns processes for controlling molecular separation or reduction, transformation and synthesis with or in the media moved in accordance with the invention.

It further relates to the procedures for achieving increases in mechanical efficiency and output as well as equipment for the carrying out of such processes.<sup>22</sup>

Pursuant to the invention itself, it is essential that the media to be conveyed are imparted a movement which conducts them inward towards the centre, in the course of which the media are conveyed through grooves, pipes, etc. By means of such laminar, inwinding, and especially a multiple inwinding motion, significant advantages can be achieved in comparison with the methods of conveying such media in use today. This occurs through the transport of the media in channels, grooves, fluting, pipes or vessels with a cross-section in the form of an egg, or more accurately part of an egg, having a curved indentation, which is twisted like a screw in the direction of flow. If pipes are used, then these should take the form of the longitudinal cross-section of an egg, but with a curved indentation incorporated on one side at the more pointed end and which encompasses a quarter or less

<sup>22</sup> Where the word Figure occurs in the following text in italics, this refers to the various numbered figures shown on the actual patent drawing shown in fig. 18 and not to those elsewhere in the book. - Ed



of the total circumference. In open conduits, the cross-section corresponds to a portion of such an indented egg-section. Under the term 'egg-shape' is to be understood the classical egg-shape or an approximative egg-shape. The imparting of an inwinding motion can also be induced through conduction along appropriately shaped surfaces.

The conduits, pipes and vessels as well as the guiding surfaces can have a straight axis, although a meandering or screw-form axis is preferable.

Through the combined orbital and rotational motion thus imparted, the conveyance of the media is facilitated and improved, and in this way a series of specific effects are achieved. Thus it was, that Professor Dr. Ing. habil. Franz Popel of the Institute of Hygiene at Stuttgart Technical University was able to establish through comparative experiments, that in an indented or fluted, egg-shaped profile, wherein the indentation is twisted like a screw in the direction of flow, the level of friction did not increase with increased volume and velocity of flow. On the contrary, at certain velocities the friction diminished and overall it was significantly less than in conventional pipes of circular profile.<sup>23</sup>

In liquids conveyed by this invention, the frictional resistance of the liquids on the inner wall-surfaces of the conducting pipe is reduced to a remarkable degree. It has also become evident that any variety of copper enhances or facilitates the inwinding motion catalytically. Instead of being wholly made out of copper, copper facings can also be used, which are affixed to the inside of the pipe. The desired results are achieved simply because the liquid comes in contact with the copper from time to time, the more frequently the better. Alloys of copper can also be used to equal advantage. Instead of copper, other metals belonging to the same electromotive series can be used, such as silver or gold.

The best effect corresponding to the intent of the invention, is achieved with the use of doubly twisted pipes. These are pipes in which the indented, egg-shaped, cross-section is first twisted along the length of the pipe and the whole then wound into a coil.

Apart from this, the desired effect can also be intensified by the application of magnets. These are either laid continuously or spaced at certain intervals along the length of the pipe.

To date it has not been known that it is possible to move liquid, gaseous or aeriform media in such a way that molecular activity can be controlled at will.

With today's conventional systems of movement, e.g. in straight-drawn, smooth pipes, the through-flowing media will indeed be transported. However, a reactive, structure-loosening tendency evolves as a secondary effect, which provokes further molecular disintegration. This cannot be controlled. These disintegrative events increase quite considerably with an

<sup>23</sup> See the Popel Report on p. 219 of this book. — Ed.

increase in velocity caused by increased pressure, additional warming or mechanical centrifugating, etc.

If the molecular structure of a moving liquid, gaseous or aeriform medium is to be maintained or a process of molecular synthesis actually inaugurated, then the aforesaid structure-loosening tendency must be prevented as a first priority.

The aim of the invention includes processes and appliances, which not only prevent unwanted molecular disintegration and the de-energising of the moving liquid and gaseous media, but also enable the achievement of molecular synthesis and a build-up of energy. These also lead to increases in mechanical efficiency and output.

In certain cases these molecular processes have to take place in a certain, special, rhythmical interplay of forces, in which expansion and contraction alternate with each other. By preventing molecular disintegration or separation, a condition can be achieved in which encrustations and sedimentation in the moving water or other liquid can be eliminated.

In accordance with the invention, the desired effect is achieved through a particular process, as a result of which the medium is primarily imparted a definite laminar, multiple-inwinding motion. It is the special construction of these pipes, conduits or vessels that makes this form of motion possible.

The molecular synthesis, recombination and transformation, energetic upgrading, bio-catalytic reduction, etc. is achieved with the processes associated with this invention:

- (a) through the laminar, multiple inwinding of the media to be moved in these involution enhancing forms, fabricated with certain materials, and if necessary,
- (b) through the addition of substances of diverse molecular and atomic structure or if need be, of trace-elements, active substances and the like, and
- (c) through the energetic bonding (coupling) of the media and the added material by means of catalysts. This can also be effected by directly or indirectly incident rays of light of different frequencies, e.g. blue, ultra-violet light, etc. The stimulation of pulsation or vibration by means of ultra-sound is also possible. Excessive structure-loosening influences of light of certain frequency bands must be reduced to the minimum value prescribed for each medium.

By way of example, the design of a conduit producing a multiple-inwinding flow-motion, which at least maintains the molecular structure of media to be moved, is to be provided with an 'open profile' and must exhibit the following features:

- (a) it must have a variable cross-sectional profile, which is envisaged as having been derived from the pointed end of an egg-shaped form, whereby in one of its longitudinal halves the near-identical profile is incorporated as a concavity. (see Figure 1 - 'open profile')
- (b) It must have a longitudinal profile that is so shaped as to take the form of a wave, or meander, as shown in Figure 2a.

The form of the conduit itself must be so constructed that along the length of the meandering longitudinal profile the convex portion of the 1/2 egg-shaped profile migrates from the right-hand of Section A-A<sup>1</sup>, via the neutral point of Section B-B<sup>1</sup>, rising to its extreme value again on the left-hand side of Section C-C<sup>1</sup>. In this process of migration the size of the indentation gradually reduces and displaces laterally.

In natural channels (streams, rivers, etc.) the previously described channel shape is the prerequisite for inwinding motion. Natural channels are therefore the prerequisite for the regeneration of the watercourse and for the maintenance of the biological laws of bio-hydraulics.

If the previously described, partial egg-profile containing the convex indentation is supplemented by fully rounded, longitudinal portion on the opposite side, then the cross-sectional form of the 'closed profile' is produced (Figure 3).

In Figure 4, by way of example, an arrangement is depicted in which a pipe with a closed profile is wound around the outer face of an imaginary cylinder.

This design can be usefully applied, for example, to drinking water pipelines, the reticulation of industrial water and for pipelines of all kinds.

If in addition an acceleration of the flow is desired, i.e. for purposes of reducing the cross-sectional area and the resultant savings in costs of the pipes themselves, then these specially profiled, closed pipes, either singly or severally, can be wound around and attached to a cylindrical core (Figure 4), which is then made to rotate. The volume conveyed and the increase in mechanical efficiency and output can be regulated by varying the rate of rotation. This arrangement is particularly suited to the conveyance of liquid, gaseous and aeriform media.

A further example of the design, which serves for certain syntheses (transformative, recombinant and upgrading processes), is depicted in Figure 5a, 5b. In these configurations the closed profile shown in Figure 3 can also be used. In this design a pipe possessing the said profile is wound around a conical, rotating core.

Depending on the desired purpose, the cross-sectional profile either reduces in size towards the point of the cone (Figure 5b), for example, for the conveyance and transformation of seawater into freshwater, or towards the base of the cone-shaped core (Figure 5a), for example, for the separation of mixtures.

For particular applications, several such pipes can be connected top to top, or bottom to bottom (for example, in the stimulation of pulsations for processes of synthesis).

Likewise several such twisted pipes can be grouped about a common axis.

Open, slotted, perforated or partially open and closed pipes and pipe systems of the above type can also be used, for example, to achieve diffusive or filtering effects.

With the possibility of regulating the rotational velocity of such pipes or pipelines, not only can the discharge velocity of the media be increased and with it an increase in mechanical efficiency and output, but also the speed of the molecular transformation can be controlled.

On the other hand, with a non-rotating pipe configuration of similar nature, the process of molecular transformation takes place over a correspondingly longer pathway.

Experiments have shown that a particularly useful shape of vessel can be developed from the egg-shape and is especially suited to the mixing, stirring, etc., of media, or the carrying out of biochemical processes and fermentation processes. This shape can also be developed from rotating egg-shaped or ovoid bodies or if necessary from paraboloid or hyperboloid, rotating bodies and the like, whereby these vessels can likewise be set in regulable rotation as the case demands.

The driving mechanism for all these rotating bodies can also be designed in such a way, that these bodies are imparted a rhythmically alternating direction of rotation. Drives of this nature require no further elaboration here, since they are already well-known to technology.

The inclusion of additives can take place in any desired fashion and relates to substances in a solid, liquid, gaseous or aeriform state, and is ordered according to the nature of the desired molecular synthesis or organisation.

The intrinsic qualities of the material required to upgrade the water must be introduced in doses in accordance with the findings of the analyses of the said drinking, medicinal and /or mineral water.

The energetic coupling, the actual bonding of these additives to the media, is achieved through the interaction between the aforesaid types of motion. The bonding takes place by way of bio-catalysts inter alia through the appropriate choice of materials from which the previously described pipes, channels or vessels are made. In such applications, copper, silver and gold and their alloys have proved to be particularly suitable. However, synthetic resins (plastics) with or without mineral or metallic inclusions or crystals, or natural stone, woods such as larch, fir, etc. and combinations of such materials can also be used.

For example, in a vessel made with an appropriate copper alloy, water with a corresponding valency (healing property) can be produced.

Catalysts and materials, elements, etc. to be incorporated must naturally have a specific, energetic proportional relation, which in any event is sufficiently well understood in the field of catalysts and their application.

In addition, the energetic coupling (bonding) can take place through direct irradiation by light of various frequencies (blue, ultra-violet, etc.) or through the mechanical stimulation of vibration, as has already been stated.

The distinctive, multiple-inwinding motion, characterised above by the orbital and rotational, inwinding tendency of the moving medium (water, earth, air, etc.) leads to a drop in temperature towards the anomaly point of +4°C (39.2°F) and its specific densation, which is the case with water in particular.

These effects are integral to the possibility of controlling the induced molecular processes and to the achievement of a substantially higher output and performance. They can be applied to drive turbines, propel ships, locomotive devices, aircraft, the conveyance of all kinds of media, to the raising of the carrying capacity and tractive force of the water in small, artificial channels, conduits or flumes, etc.

The increase in performance itself is to be attributed inter alia to the substantial elimination of the centrifugally-acting, reactive wall-pressures. In all systems of motion of this nature, the speed of motion is increased. The process of molecular syntheses is strengthened through the increase in specific density.

In the case of rotating pipes, pipes systems and vessels, a regulable reversed flow and/or counter-rotation occurs between the rotating forms and the media moving through them, which accelerates and augments the aforesaid processes as well as the mechanical increase in output and efficiency.

Accordingly, the areas of application of the invention are manifold and of extremely wide scope. The implementation of this process and the associated appliances has proved to be particularly effective in the prevention of encrustation in pipes, sedimentation in channels, the transformation of seawater into freshwater with a range of properties, the biological purification of polluted drinking water and general purpose water, and in high-grade molecular syntheses. It is equally suited to processes of energetic concentration and transformation, for example, in the transformation of molecular structures of liquid nature into gaseous, ethereal or volatile states and vice versa. It demonstrates the nature of the build-up of blood, and sap in the world of plants.

It should also be mentioned that, as a result of this invention, new designs for turbines, propulsion systems for ships and aircraft, and differently designed water reticulation and transfer installations can be developed.

With more specific reference to the invention itself, it should also be noted with reference to Figure 6, that the movement mentioned above (which can equally take place in the opposite direction), and multiple inwinding movement in particular, should be conceived as the tendencies represented in

Figure 6. In this figure, which depicts a closed profile, D is the direction in which the profile itself rotates and E is the direction of the tendency to inwind.

As inwinding forms, apart from the inwinding motion described above, equal consideration should be given to the coiling of the profile shown in Figure 6 about various other forms depicted schematically in Figures 4, 5c & 5d.

These other forms can also include an extended egg-shape (tear-drop shape) or a contracted (extreme) egg-shape.

Amongst the base core-forms mentioned above, inwinding tubes or systems of inwinding tubes of a special design can be incorporated (as in Figure 7).

Curved or inwinding tubes of a special shape can likewise be attached to the external envelope or the internal periphery of the bodies of the rotating conical shapes or the others described above, whose spiral configurations rotate in opposite directions, for example, a left-hand external spiral and a right-hand internal spiral configuration, or vice versa.

## Patent Claims

The invention is characterised notably by the following features and possible permutations and combinations:

1. Procedures for the control of processes of molecular decomposition, transformation or composition taking place in the moving media, liquid, gaseous or aeriform through which an increase in mechanical performance and output can be achieved; Procedures characterised by endowing the media with a particular laminar movement, which then inwinds upon itself several times in the above conduits, tubes or receptacles of a certain shape and material conducive to such form of movement.
2. Given that different media have different molecular and atomic structures, these are transformed into molecular organisations of different nature through the interactions occurring during such laminar multiple-inwinding movement by means of energetic coupling.
3. Elements existing as trace-elements, active substances and such like are incorporated into the said processes in order to contribute or participate in the energetic interactions.
4. The energetic interaction (coupling) between the media or substances is produced, for example, by way of catalysts, which amongst other things, desirably correspond to the base material of the artefact, or through the direct or indirect production of oscillations (for example, light of different frequency regions or ultra-sound), the said interaction being additionally assisted by the production of mechanical oscillations.

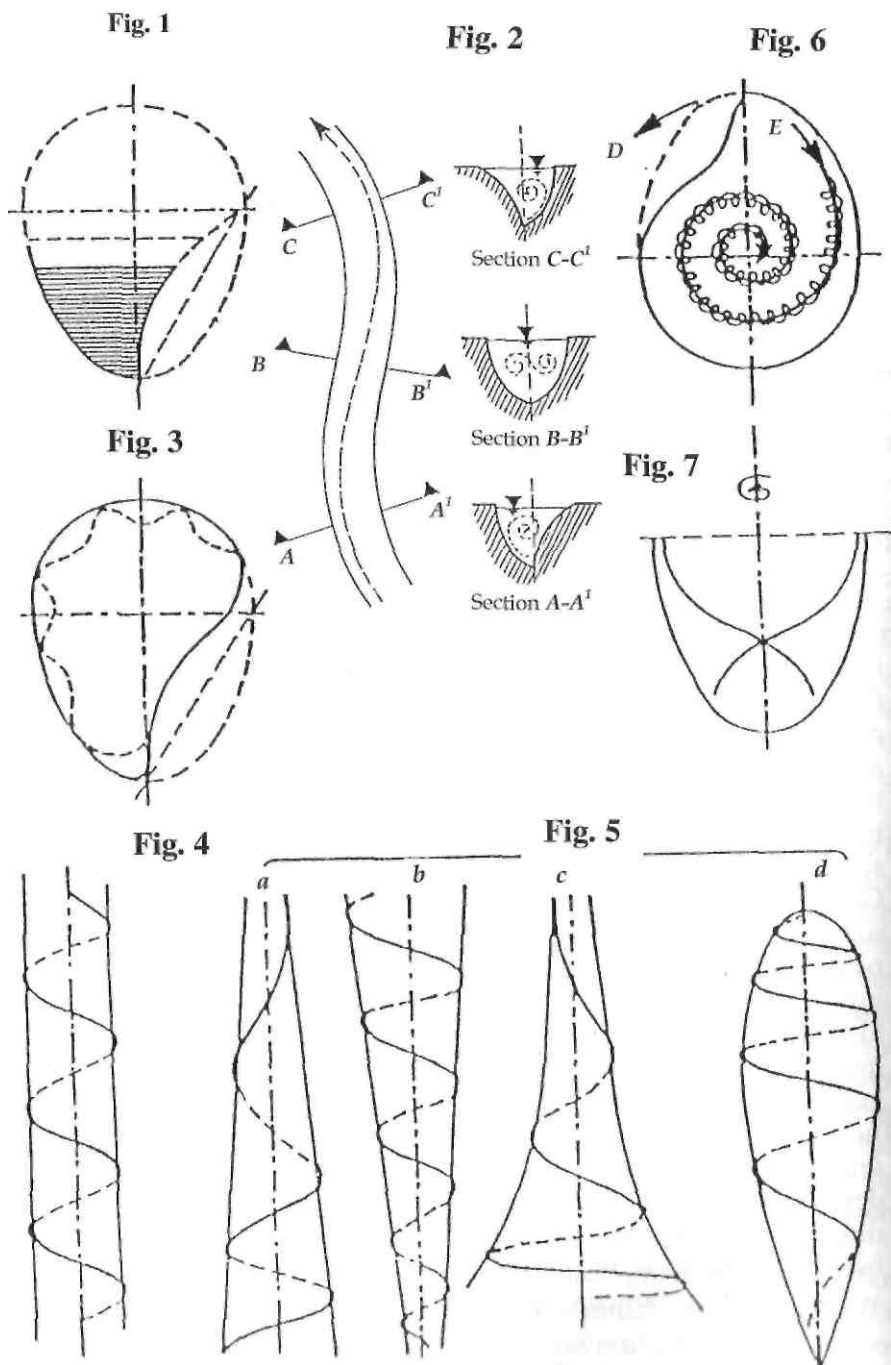

Fig. 18: Double spiral pipe diagram - multiple patents

## 6.

# The Air Turbine

## Letter to Werner Zimmermann

From Spec. Ed. Mensch und Technik, Vol. 2, 1993, section 2.0. (4th February 1936 - extract)

**A**part from the 'production of petrol from water', the exploitation of which we will be discussing later, I have stumbled on something which perhaps will change the whole of technology and commerce from the ground up. On the 22nd of January (1936) I was granted a patent (No. 145,141) for an air-turbine (a breathing machine) (see fig. 19). The principle of this vacuum-turbine consists in the fact that an artificial thunderstorm, or high-tension electrical charge develops in a capillary tube and a double-spiral pipe in which electromagnets have been incorporated, which transforms the substances of the air into electrical energies. These discharge into the sidewalls and from there, through diffusion, are ducted away downwards as heat. Through the transmutation of aeriform matter into energies, a self-intensifying physical vacuum is created in an upward direction and through the recurrent development of a heat gradient in a downward direction, a powerful upcurrent of air evolves, which after a few minutes intensifies to cyclonic force. Because the air-pressure in an upward direction can be progressively reduced in this extremely simple way, the counterflow of air can be raised to over 200 kph (124 mph), producing about 10,000 brake horsepower on the inclined surfaces of the propeller (turbine).

This opens the way to the development of fuel-less, silently moving aircraft, because the physical vacuum evolving inside the machine at the forward end creates an airless space immediately in front of the machine into which the machine itself is drawn. Through the appropriate adjustment of the internal system of lungs or gills, the intensity of this suction can be varied. In this way the motive force and the speed of the apparatus can be increased as desired,



because the repulsing reverse-thrusting piston-like columns of air are themselves the fuel. Once this fuel has been decomposed analytically, it triggers the physical counter-current through which the suctional forces arise.

With this invention I have finally achieved what I have been striving for these last 20 years, namely to make the use of coal, oil and hydro-power no longer viable. These substances are predestined for the production of food. Their increasing extraction from the organism of the Earth will inevitably lead to problems of food supply, because the constantly rising world population increasingly robs the Earth of those substances that support life. Since no combustion processes are involved, the aeriform substances transformed in the machine create very high-grade nitrogenous material, which increases the vitality and germinating capacity of the vegetation. Thus I have struck a blow against the technologists, who utilise the substances required for food production to create motion by means of hot combustion and hence bring the natural processes of growth to a complete standstill.

Air-masses super-saturated with oxygen will become the sole fuel of the future. This will reduce the mechanical and physical air pressure on the Earth and even in low-lying areas, mountain air-conditions conducive to increasing the vegetation will prevail and at the same time tropical changes of climate will eventuate, which will counteract the coming ice-age. These machines will completely change the whole of the world economy and make wars, etc. unnecessary, because a superfluity of vegetable matter will automatically arise. Of necessity this will have to be consumed, if the creation of excess negative energies, as happens today, and therefore the development of elemental catastrophes are to be avoided. In this way charity and tolerance will become the dictates of reason, because the increasing turnover will be transformed into prosperity. That is to say, that love of one's neighbour, which cannot be instilled with threats of hell and damnation, will become established in this way and indeed will actually become an object of speculation for humanity.

I am now working feverishly on the completion of this highly simple and cheap breathing-machine and I hope to be able to show you the finished work at the end of the month. Then your work begins, namely the work of the Sermon on the Mount, the call to reason, whose purpose is the turning inside out of contemporary economics and falsities. It is fate that has brought us together. I reiterate emphatically that you can rely on me 100%, because I am in a position to furnish you with material that will make the whole world sit up and take notice and will create such a stir, that people will come to you from all corners of the Earth once you begin to preach. It is my job to research to seek and to unveil. Your job is to speak and explain and in this way your circle of business acquaintances will become what it should be; the focus of power that spreads like a wave and envelopes whatever is still possessed of a spark of reason.

## The Vacuum Turbine

From Spec. Ed. Mensch und Technik, Vol. 2, 1993, section 7.6.

The principle of this vacuum turbine consists in the fact that in a capillary tube and a double-spiral pipe in which electromagnets have been incorporated, an artificial thunderstorm or high electrical atmospheric charge develops, which transmutes the elements of the air into electrical energies. These discharge themselves into the sidewalls and from there are conducted downwards as heat by way of diffusion. Through the re-formation of aeriform substances into energies, a self-intensifying physical vacuum is created in a forward or upward direction and owing to the succession of downwardly directed heat-gradients, a strong upcurrent of air develops, which after a few seconds intensifies to cyclonic force. This provides the basis for silent, fuel-less aircraft, for through the physical vacuum created inside the machine, an airless space develops in front of it into which the machine itself is sucked. This suction can be intensified at will through the appropriate adjustment of the system of gills and lungs in the machine's interior, so that the motive force and the speed of the apparatus can be likewise increased as desired, because the repulsing air-piston is the actual propellant which, decomposed analytically, unleashes the physical counterflow.

## The Formation and Composition of Riverwater

A reply by Viktor Schauberger to a newspaper report - Implosion Magazine, No. 84.

I thank you for your last letter and enclosures, which interested me particularly, because this is the fourth instance of rivers flowing uphill. These cases cannot be explained purely mechanically. In the Tatra mountains of Czechoslovakia there is a river, which over a distance of about 15 km (9.3 miles), overcomes a reverse-gradient of 64 metres (210 ft). These phenomena are painstakingly kept secret, because it is feared that an exhaustive analysis of them would bring about the collapse of the Law of Gravity. These statements are closely related to my own discoveries, which can be exploited practically and perhaps will change contemporary technology completely. Tackled correctly, power will cost virtually nothing. Science made a gross error in defining water with the chemical formula  $H_2O$ . Should there be any formula for water at all, it should look like this:

Water is the most ideal accumulator and transformer in which the direction of movement alone determines whether magnetic or electric currents are produced. These are of organic origin and decompose either air and water, so that

the three primary elements hydrogen H, carbon C and oxygen O are released. Under the appropriate arrangements C and O combine to become organic electricity. The freed H streams upwards at great speed and, through a double-spiral motion (a secondary spiral flow about a primary spiral path), attracts to itself the difference-matter (variously potentiated elements) of the air, resulting in the recreation of water and air.

If the vortical current streaming upwards in a specially constructed tube is braked against a propeller, then at a rate of 4,000 litres (141.25 ft<sup>3</sup>) of air per second, which rise at a velocity of 200 kmh (124 mph), this produces an active force on the shaft amounting to 996 hp. To analyse 4,000 litres of air only 3 - 4 hp are required, so that the above 996 hp represent free, usable energy. This kinetic principle is founded on thermo-electric processes that we can observe in Nature in the formation of cyclones, storms, etc. These implosive processes can be simulated artificially and enable tremendous energies to be unleashed in the smallest machines, when organic catalysts, similar to those in the lungs and gills, are agitated and which dissociate either water or air into its basic constituents. The dissociated H is the attracting magnet for the surrounding air-masses, which in the process become so condensed, that inside the machine the potential pressure of the air falls by over 100 mm (4 in.), provoking a powerful influx of the air-masses lying immediately in front of the air-intake, which in turn creates a zone of rarefaction into which the machine is impelled. This actually represents the discovery of the silent and fuel-less aircraft, which correctly simulates the flight of birds organically.

Our work here progresses only slowly, because the people are heavily over-worked and we have been waiting for the components for months. We are here concerned with a machine, which should deliver 1,000 hp, requiring a driving force of only 4 hp to do so.

What you have represented as a phenomenon in your newspaper report will be a self-evident phenomenon once this machine has been built, because with it one can lift water to any height without effort and almost without any input of power.

The Hindenburg accident in those days is to be attributed to similar processes of dissociation, or more precisely, to synthetic reversed metamorphoses. The crash of the American airship, the Akron, which was filled with helium, is equally attributable to short circuits. With hydrogen, fire is created, and with a filling of helium - water. The analogous counterpart to the helium synthesis we find in the natural formation of rain.

One day it would be very interesting to clear up the question, whether humanity consciously or unconsciously lost these simple processes of Nature. In my opinion, it happened unwittingly, because in earlier times people had no conception of analytical or synthetical processes and 50 years ago the science of radiation physics was virtually unknown.

It is beyond doubt, however, that the Atlanteans possessed silent aircraft (vimanas). It is at any rate possible that at the time the priesthood preserved the secrets of catalysis, which in the course of time were simply lost. I arrived at the whole affair through observations of the motionless trout in torrential currents and through the accurate observation of bird-flight, which without physical exertion takes place entirely through processes of diffusion<sup>1</sup>. I am convinced that we now stand before an upheaval, which will fundamentally change all realms of knowledge and belief, for in my opinion the discovery of the way to produce an abundance of food will provide the basis for all manner of political development. This abundance first has to be lost with the continuing development of our present technology, because it is only in this way that humanity will bring about its own ruin through its own handiwork and come to realise the stupidity of its activities.

## Re: The Air Turbine (Austrian Patent No. 145141 - 15.03.1935)

Excerpt from *The Discovery of Levitational Force*, Salzburg, 1949, Implosion No. 115, pp 36-37

With high frequencies, which can be regulated as desired, this patented device produces an almost absolute void (vacuum), causing air to move at such high velocities per unit of time that any desired power can be obtained by means of a propeller-like resistance to motion.

This patent is founded on the discovery that constant pressure or suction, whether generated by mechanical or physical means is immaterial, triggers a

resistance that increases by the square of the velocity generated by either of them. This happens for the simple reason that under abnormally high pressure, for example, the state of aggregation (not to be confused with the natural variation in developmental states) of air is transformed instantaneously into water, and under strong suctional velocity, water into air. In the first case, by way of a reactive intensification, an almost absolute vacuum (or more properly, an almost 100% air-less vacuity) is created. In the second case, a counter-pressure of such magnitude evolves, that any further attempt to achieve a greater reactive reduction in volume would be futile.

The above patent (No. 145141 - 15th March 1935), however, has long been superceded and is therefore only of historic interest, because incomparably more powerful reactive forces can be generated, which increase performance

<sup>1</sup> See how is a bird able to become temporarily independent of the ground ?' on p. 14 of *The Fertile Earth*, Vol. III of the Ecotechnology series. - Ed

instead of reducing it. In the case of the above patent, if this process is merely reversed, then the following happens:

The so-called oxygen of the air is combusted by two periodically pulsing electric (therefore decomposive) flame-arcs. This creates an exhaust gas, which can only be extracted by strong centrifugal pressure.

To this end a very specially constructed egg-shape is required, which rotates at high speed.

This particularly shaped and alloyed egg-form contains an equally specially shaped and alloyed system of curves, which only produces a reaction in the exhaust gases, but not in the renewed inflow of oxygen or any small quantities of combustible gases or liquids.

In this way an expulsion of exhaust gas occurs, whose velocity can be effortlessly increased to 10,000 m/sec (32,800 ft/sec). The velocity of this exhaust emission is inhibited by the full-throttle velocity, which can be raised by the square of the exhaust velocity easily and cheaply.

The interposed brake-propeller transforms these powerful suctional velocities into useful power that can be regulated and increased at will. Modern science on the other hand uses this braking-propeller for forward propulsion, despite the fact that its use produces pressure- and heat-intensifying and therefore reversed reactions - and is thus a resistance-triggering device.<sup>2</sup>

This fact should put an end to today's science (technology, hydraulics and dynamics), which without exception triggers the reversed force that produces braking reactions.

For this reason it can no longer be claimed that annihilating fire and the temperatures, etc. arising from this epicentre of destruction are still necessary, if a process was researched and put in place that enables the ur-generation of the highest-grade forces of pressure and suction that exist on this planet, which like the energised effects of urge and yearning, function at the speed of thought.

This process, which involves the natural acceleration of mass without combustion or heat, is therefore not founded on fire.

<sup>2</sup> "As best demonstrated by Nature in the case of the aerofoil maple-seed, today's propeller is a pressure-screw and therefore a braking screw, whose purpose is to allow the heavy maple-seed to fall parachute-like slowly towards the ground and to be carried away sideways by the wind in the process. No bird has such a whirling thing on its head, nor a fish on its tail. Only man made use of this natural brake-screw for forward propulsion. As the propeller rotates, so does the resistance rise by the square of the rotational velocity. This is also a sign that this supposed propulsive device is unnaturally constructed and therefore out of place." Viktor Schaubberger, Implosion Magazine, No. 112, p. 52. — Ed.

## An Air-Turbine Patent

AUSTRIAN PATENT OFFICE  
SPECIFICATION OF PATENT No. 145141

Class 46f.

Issued 10th April 1936

VIKTOR SCHAUBERGER IN HADERSDORF-WEIDLINGEN,  
LOWER AUSTRIA.

AN AIR-TURBINE.

Application date: 7th March 1935 - Patent applies from: 15th November 1935

It is known that impellers can be caused to rotate by moving air. It is equally known that an air current can be generated through evacuation. The present invention, however, makes use of mechanical and physical forces.

In the accompanying diagram (see fig. 19), the object of the invention is portrayed in Sections A-A and B-B. A snailshell-shaped housing a in which the impeller b is mounted is connected to a double-spiral pipe c by means of a hollow shaft d. The double-spiral pipe c is joined to an egg-shaped, hollow body e at f, which is divided into two spaces by means of a wire mesh g. In the inner chamber of e gas-burners or electric arc-throwers are incorporated that combust the inflowing gas at about 2,000°C (3,632°F). The inner chamber is connected to an exhauster via a heatable double-spiral pipe h. To this exhauster, streamlined, egg-shaped nozzles i are attached and the whole arrangement is activated by an external force.

The impeller incorporated inside the snailshell housing is constructed in such a way that fresh air can only enter the hollow shaft d when the impeller-blade k passes over the slot j incorporated in the hollow shaft. The flywheel l, whose cross-sections are egg-shaped and which is mounted on the hollow shaft d, is installed in an externally airtight housing m. The air present in the hollow space n is sucked out through a connecting passage o, so that in the highly rarefied space n the flywheel is offered very little resistance to rotation. To maintain the combustion process, a combustible gas is introduced at p. The double-spiral pipe c mentioned at the beginning has been granted an Austrian patent, No. 138296. This pipe consists of an external pipe made of wooden staves and an asbestos sleeve. Within the latter there is a metal sleeve, which has wood-shaving-like metal elements bent out from the periphery, whose axis is inclined towards the pipe-axis at an angle of 30° to 45°. <sup>3</sup> These metal elements are aligned along several spiral pathways. The

<sup>3</sup> See description of Patent 138296 on p. 202 of *The Water Wizard*, Vol. I of the Ecotechnology series. — Ed.

peripheral air-masses will thus be forced to describe a path corresponding to a spiral within a spiral.

The inner metal sleeve is heated electrically. In addition, the heat arising from friction on the outer walls leads to the warming of the outer air-masses, through which in particular all the oxygen contained in the air expands, concentrates itself at the pipe-walls, becoming even warmer on its multi-spiral path along the pipe-walls. The remaining gases contained in the air pass down the centre of the pipe and rise through the agency of the gas introduced at p.

Because the warmer and therefore more aggressive oxygen brushes along the outer pipe-walls and the colder residual components of the air flow through the inner region of the pipe, inner tensions arise between the materials due to the temperature differences obtaining, which become more pronounced the longer the distance travelled, until interactions ultimately occur. These interactions proceed in the form of small explosions and assist the reaction that takes place through the combustion of the highly energised gases within the egg-shaped safety mesh g.

In the egg-shaped body e a sieve (safety mesh) g is incorporated, outside of which the separated oxygen mentioned earlier accumulates, passes through the sieve into the centre, wherein, with the aid of the electric or gas arcs, it contributes to the almost complete combustion of the centrally conducted combustible gases. As a result a much greater vacuum evolves than has hitherto been achieved using currently known methods. At the same time the exhaust gases are reduced to a minimum and extracted mechanically via h and i. Through the creation of the vacuum in e, the air will be sucked in with even greater force, setting the impeller in motion in the process.

## Patent Claims

1. The air-turbine is characterised by the fact that the air-masses in a double-spiral pipe can be so strongly moved, that due to frictional heat and externally supplied heat between the peripheral air-masses and those streaming down the pipe-axis, differences in temperature arise, which lead to cold interactions in the air flowing through the double-spiral pipe, whose end-product is an almost total vacuum.
2. In accordance with Claim 1 the air-turbine is further characterised by the complete combustion that takes place in a partitioned chamber by means of a safety mesh having a pipe-shaped extension towards its base.
3. In accordance with Claims 1 & 2, the air-turbine is characterised by the fact that the attached flywheel is caused to rotate in a rarefied space.
4. In accordance with Claims 1-3, the air-turbine is characterised by the fact that the supply of air takes place pulsatingly through a slot in the hollow shaft.

5. In accordance with Claims 1-3, the air-turbine is characterised by the fact that the discharge of exhaust gases takes place by means of a heated pipe in which a temperature higher than that of the exhaust gases prevails.

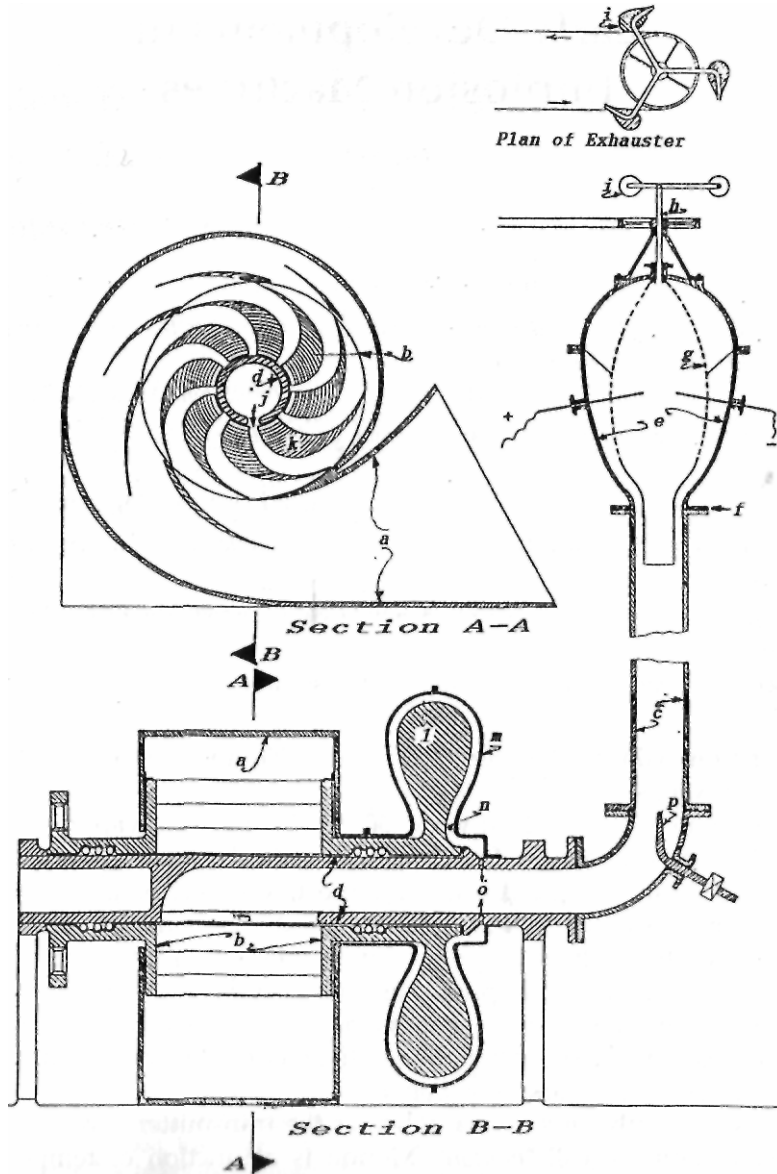

Fig. 19: Air-turbine diagram - patent No. 145141



## 7.

# Early Developments in Implosion Machines

"Implosion is no invention in the conventional sense, but rather the renaissance of ancient knowledge, lost over the course of time."

Viktor Schauberger, Implosion Magazine, No. 83. p.16.

"In every case do the opposite to whatever technology does today. Then you will always be on the right track."

Viktor Schauberger, Implosion Magazine, No.36, p. 3.

"You must learn to think one octave higher. Only then will you learn how implosion energy works."

Viktor Schauberger, Implosion Magazine, No. 83, p. 27.

From Spec. Ed. Mensch und Technik, Vol. 2,1993, section 7.4.

In a letter from Viktor Schauberger to Werner Zimmermann of the 21st May 1936, Viktor writes:

"This machine (30 cm [12 in] wide, 50 cm [20 in] high) vaporises, purified and distils water by means of cold processes. At the same time, it will raise water to any desired height, for which almost no power of any kind is needed. My machine is a body, which consists of internal and peripheral nozzles, which replace the valves of present machines or supplement them. My machines only require the impulse and manifest the reaction as an expulse, which not merely presses, but simultaneously sucks. This then results in the creation of resistance-less motion, due to the reciprocity, which today's resistance<sup>1</sup> makes use of as a 'means of propulsion'.

The body is merely an antenna, whereas the transmitter is responsible for the phenomenon we call 'motion'. Motion is a function of temperaments, which within and about themselves are possessed of plus and minus in

<sup>1</sup> Here the use of the word 'resistance' may actually be intended to apply to the scientific establishment. — Ed.

diverse shapes and sizes. Hence by altering the inner-atomic structure, we can displace the centre of gravity and thereby achieve that which we regard as pure, resistance-free motion; a motion, however, we have for so long not understood, because we ourselves are the resistance, which under the most difficult conditions, has to move itself in order to evolve."

## The Atom Transforming Machine

From Spec. Ed. Mensch unci Technik, Vol. 2,1993, sections 7.7.7-7.7.10

### 7.7.7 Notes from 15th July 1936

Today we began to assemble the atom-transforming machine. Tomorrow or the day after it will run for the first time. Simple and true, that is the impression one gets when observing it. Unfortunately, in its present state we cannot make the upper part of the machine fully operational. The danger is too great. I cannot risk the lives of my co-workers. Fully operational, the machine must be remote-controlled, for either a violent thunderstorm or a cyclone will develop; If the organic H discharges itself downwards, then there is a short-circuit - a thunderstorm, whereas an upward discharge of H produces the celestial electromagnet, which is actuated at about 40,000 milli-amperes, and with it the charging up of the celestial Plus + Minus, i.e. the cyclone. The physicist Renault produced a short-circuit, which incinerated him and his colleague in a matter of seconds<sup>2</sup>. Perish the thought that it should first ignite

<sup>2</sup> There follow some short extracts pertinent to the above. Here is an interesting extract from one of Schauburger's writings (TAU 145, page 18), concerning the extraction of energy from water: — Ed. "...and thus I succeeded not only in producing petrol-like explosive aqueous substances and the most noble high springwater from dirty water, but also in recreating an invention, which the well-known physicist Gerard Renault had apparently made in his day (1926), and to which he and his assistant fell victim at the Paris Academy because he failed to recognise the enormous energies latent in water and in the air."

The following extract from the periodical *Der Weg* (7/11/1946, 1st year, no 48, p. 12) gives a fuller indication of what Renault was working with:

The French physicist Gerard Renault had already occupied himself with the problem of obtaining electricity from the air. In his laboratory in Grenoble he worked night and day on his invention and even the scant information that emerged publicly created a sensation in scientific circles. One day a machine stood in his workshop which was held to be a wonder. Day after day its wheels turned without any observer being able to determine whence the driving force originated. Neither steam, nor combustion gases, nor electrical motive forces could be detected. The machine stood on its base, completely insulated from the ground, and ran independently like a perpetuum mobile. For a while Renault enjoyed the general wonderment, and then one day he said, "This machine is in fact driven by electricity, but with electricity from the air! I have solved the problem. With its practical application, in a few years we shall achieve a paradise on Earth." The French Academy requested Renault to come to Paris so that he could demonstrate his invention there. The inventor agreed, hastening to the capital with his assistant, setting up his machine in the experiment theatre. Just before the beginning of the demonstration, he wanted to explain how it worked. His assistant was present. Suddenly there was a tremendous explosion, flames shot out of the doors and windows, and once the fire brigade had succeeded in extinguishing the fire, the machine was a heap of wreckage. Renault and his assistant died in the explosion. They took their secret with them to the grave.

on the transverse axis! It entirely depends on where the H discharges. On the transverse or vertical axis? This determines the stronger pole, for here too a bipolarity is involved.

### 7.7.2: Notes from 24th July 1936

In terms of their actual manufacture the machine's components have not been properly fabricated and now, unfortunately, I have to have the whole work carried out again completely, because I cannot achieve the required revolutions. The first trial demonstrated an important law, namely that the Sun's rays decrease in capacity with an increase in heat. This gives rise to the possibility of producing cold light or cold fire artificially and in further consequence, the absolute cure of cancerous diseases.

Through the organic arrangement of the cathode and anode systems, I achieve planetary motion in the machine by adjusting the potential angle of  $+4^{\circ}\text{C}$  ( $+39.2^{\circ}\text{F}$ ), whereby either light - the primary ur-structure, or motion - the primary ur-dematerialisation, is initiated. If I set cold light and warm motion in a harmonic rhythm, then I obtain a growing motion, or the living force of the Almighty.

So-called short-wave radiation is none other than hard unprocessed un-demodulated radiant energy, which can be generated to any intensity with the organic machine. From this arises the mutation, the inversion of the creation-of-motion, that is, the waxing motion-of-creation or free energy. For this reason I require an initial inward-moving force in order to set the machine in dynamic motion. Once the required revolutions per minute have been reached, then the warm motion begins to grow.

If this waxing mass-motion in the double-spiral pipe is now slowly cooled, then absolute dematerialisation is achieved; that is, pure heat or cold energy and with it the separation of the Ur. This H is the organic polarity or the earthly motive impulse, which as a result of the relaxation of its inner tension now displaces itself and streams upwards. On its way to the pole, this negative impulse sucks the aeriform substances towards itself, thereby producing a vertical vacuum or a cyclone in the air.

### 7.7.3: Notes from 25th July 1936

This week I checked over the machine, which intentionally or unintentionally had many faulty components. I will have nothing more to do with engineers in the future. In the final analysis they are dishonest and stupid.

#### 7.7.4: Notes from 27th July 1936

It is done! At last I have achieved planetary motion! Wanted to smash the machine to smithereens. Inside it everything happened contrary to my expectations. Burning candles showed me the way in which the dematerialising substances operate. Window-sill - smooth surface - the Moon's motion. Now all has been solved!

I have a very heavy week behind me. It seems as though Nature refuses to reveal her final secret of bio-motion to me. Everything was other than I had imagined. Something was always missing and I really began to doubt. What was missing were the functions of the moon and cold light. A brain-wave! It was almost a dispensation of Providence that placed the solution to the puzzle in my hands. Two flies at one blow! 1. Cold light. 2. The axial motion of the moon.

With this machine, which can do almost anything, it would be a simple matter to create my own monopoly and peddle both heat and cold-producing devices, thereby raising funds for further research in other fields. The secret of this machine lies in the mirror-image inversion of what today is held to be true. Because of these misconceptions neither the economics, nor the results add up. In the sacred waters lie the eternal forces of the Earth and the air. One grows out of the other and the boundary conditions of these 'Three' are: the overcoming of gravity and the densation of life into matter - the creation-of-motion and the motion-of-creation.

#### 7.7.5 : Notes from 1st of August 1936

I am now able to construct the organism of this machine in such a way that it ceases to function the very moment it is opened up. In exactly the same way that a living body ceases pulsating when the heart is opened, my machine also stops functioning if an inquisitive person wishes to examine it anatomically.

#### 7.7.6 : Notes from 11th of August 1936

This machine is a tool with which it is possible to ennoble solids, liquids and gases to such an extent that the end-product exhibits a manifold increase in quality and dynamic capacity. The principle has been copied from Nature, wherein decomposition (analysis) - (creation-of-motion) - and synthesis - (motion-of-creation) - take place by way of bio-dynamic movement. If air is decomposed, for example, then a high-grade ethereal product is created, which can no longer maintain its station in the atmosphere, but streams upwards at high speed. The uprising gas absorbs the surrounding aeriform

substances and in this fashion, a vertically moving vacuum evolves, or a cyclonic flow.

The decomposition of fresh water or seawater produces the same effect, and the upward streaming hydrogen gas can either be made to flow through suitable carbonates or precious metals and minerals, whereby in the first instance a petroleum-like substance is created and in the second, depending on the absorptive mass, a more or less high-grade fuel-water is produced. The petrol-like substance can be made combustible or incombustible. In the latter case we are concerned with a nitro-glycerine-like substance, which can be dosed as desired. The nature of this substance may be similar to the so-called 'Greek Fire'<sup>3</sup>. The raising of the liquid and the cooling to +4°C (+39.2°F) results spontaneously from the decomposive process and the ethereal structure of the product of decomposition.

#### 7.7.7 : Notes from 13th of August 1936

After 20 years of effort, I have arrived at the almost absolute 'nothing', namely the near-absolute 'vacuum'. A vacuum-machine is a machine that is specifically designed to function with planetary motion and only requires an impulse in order to run for as long as the machine's organic components are capable of life or movement. A drive-motor is not absolutely essential, because the initial impulse can be given with the hand or by means of foot-pedals. The whole secret lies in the organic creation-of-motion and motion-of-creation, through which the bi-polar development evolves spontaneously, namely the dematerialisation of the material and the overcoming of gravity on the one hand and the densation of matter and physical growth on the other.

#### 7.7.8 : Notes from 14th of August 1936

I stand face to face with the apparent 'void', the compression of dematerialisation that we are wont to call a 'vacuum'. I can now see that we are able to create anything we wish for ourselves out of this 'nothing'. The agent is water, the blood of the Earth and the most universal organism.

<sup>3</sup> Greek fire: 1: A Byzantine weapon employed in naval warfare from 672 or 673 AD. It consisted of a mixture, usually shot from tubes, that caught fire when wetted. 2: any of several other inflammable mixtures used in ancient and medieval warfare." — Collins English Dictionary.

Greek fire: A combustible, highly ignitable composition for setting fire to an enemy's ships, also known as St Elmo's fire, elixir vitae or composant fire. Oxford English Dictionary. — Ed.

St. Elmo's Fire: Aluminous region that sometimes appears around church spires, the masts of ships, etc. It is a corona discharge in the air caused by atmospheric electricity - also called 'composant fire'. - Collins English Dictionary.

### 7.7.9 : An eye-witness report:

Gretl Schneider relates: "Mr Viktor Schauburger has demonstrated the machine to me. The previous huge construction is no more. It has been reduced to half its former size and in operation develops enormous power. I poured a jar of water into the bottom of it. The machine produced an almost inaudible sound and then a 'pfft' in the same instant and the water pierced right through a 4 cm (1 1/2 in.) thick concrete slab and a 4 mm (5/32 in.) thick super-hardened steel plate with such force that the water-particles, invisible to the eye due to their high velocity, penetrated right through all clothing and were experienced as lightning needle-pricks on the skin. Waterglass was also pressed through and solidified in 5 cm (2 in.) long hairs on the outside of the casing, like bristles."

### 7.7.10 : Report of Arnold Hold's visit, 14th-17th August 1936 (Arnold Hohl)

Dismantled machine: The overall concept is remarkably interesting. Like a Vesuvius made of gold and silver with several craters disposed around the point, about 20 cm (8 in.) in diameter. Conspicuously heavy, all made of metal.

"And it floats in the air", said VS, even though it rotates at about 3,000 rpm. Reflecting the internal vacuum system, the outer casing is like a Roman water-pitcher (amphora) made of silver-plated brass. "In the whole machine there is no straight line and no circle", reiterated VS.

Vacuum and pressure so great that the finest water-vapour could exit through slots (at 1 cm (3/8 in.) centres). It even forces waterglass through, which hangs down outside in long threads. The finest water-vapour, only detectable with a mirror. Nickel-plated hub with movable metal pipes in which a series of butterfly wings were riveted in a spiral configuration. Placing one's ear to it, one heard a seashell-like sound. No electric drive, but only hand or foot-pedals are necessary. The motive impulse has to be repeated periodically. The machine must be taken apart in order to seal it more effectively<sup>4</sup> and to examine the material. Within 5 minutes the forged casting was heavily rusted as though it had lain in water for 14 days. Temperatures vary from +4°C to +800°C (+39.2°F - +1,472°F): Rpm from 6,000 to 30,000.

O = oxygen = pressural force - separation actuates centripetal force.

H = hydrogen = suctional force - combination actuates centrifugal force.

O = transverse potential = electricity.

H = longitudinal potential = magnetism.

If a very fine tube is placed beneath an egg to be incubated by a chicken, which allows air to flow through to the egg, then the hen sits on it for only

<sup>4</sup>It even broke a mercury seal. — Ed.

3-4 days and then pushes it aside. She then takes a new one, and so on, because in this way no chicken (foetus) can develop. That is the secret of the needle-jet.

Cut the grass early in the morning only, because something very exceptional is associated with the scythe's cut. The grass, or rather the haulm is a small tube or a minute orifice. Because it is made of iron, the scythe attracts atmospheric oxygen and releases hydrogen in the process of cutting.

The hydrogen, however, seals the orifice instantaneously so that the grass neither bleeds to death nor transpires and the roots are not deprived of energy. Whoever mows in sunlight, destroys the roots and with time the field becomes barren.

## The Implosion Machine

An assembly of extracts from Implosion Magazine, Nos. 45, 56, 57, 58, 60 and 83.

Every whorl-pipe is a tornado, a vortex. The flow-through material creates a space-spiral. From the starting point movement is both inwards and downwards at the same time. The whorl-pipe must be cone-shaped on its longitudinal axis. In experiments with cylindrical pipes few noteworthy effects were achieved. In addition, there is also a third direction of movement, which seems to be the most important. It is a rotation about itself, which in regard to the electrons in atoms we call 'spin', or which we can see with couples when dancing the waltz.<sup>5</sup> Viktor Schaubberger sought to achieve this rotation about its own axis with the oval (egg-shaped, not elliptical) profile of a pipe with a rotating indentation on the longitudinal axis. For this design he also applied for patents (see fig. 18), which were only partially successful. The acceleration of the in-rollment of the flow-through material depends on four factors:

1. The length of the pipe,
2. The size of the intake cross-section in relation to the outlet nozzles,
3. The rotational velocity of the rotor,
4. The diameter of the conical rotor, because it is upon this that the centrifugal force depends.

The rotor is a conical bell. The whorl-pipes are attached either to the outside or inside of a collector. Due to the centrifugal load it is advisable to mount them on the inside. From the collector a suction-pipe extends vertically downwards into the water reservoir of the machine.

<sup>5</sup> In 3/4 time, like the heart-beat, the waltz is one of the most natural, dynamic, energy-producing, rotating planetary movements. — Ed.

The rotor is driven by an electric motor, which is connected to the alternator or generator that produces an electric current. To begin with the drive-motor is powered from any available current source in order to set the rotor in motion. When the rotor produces more power than the drive-motor requires, electricity can be ducted off for other purposes. According to estimates, the proportion is in the ratio or 1 : 9, namely 1/10th of the output for running the drive-motor and 9/10ths as surplus power. The implosion machine is a therefore more than just form of perpetual motion.

The power of the machine results from four impulses:

1. As connected to the suction-pipe, every whorl-pipe is a siphon, whose function we know from school physics. As a fall-pipe, the whorl-pipe is longer than the vertical suction-pipe. Its exit nozzles are at the same height as the lower end of the suction-pipe. Only a slight impulse is therefore required to trigger the flow of water.
2. As soon as the rotor reaches top speed the water is centrifugated against a fluted outer wall with enormous force. As it impacts a dense electrical force-field evolves, in which the weight of the water is neutralised. This electric charge can be increased by the rotor's rate of rotation. The water rises, without being lifted, in the suction-pipe and passes into the whorl-pipes from the collector. The fall-weight is the impulse that enables the ducting off of surplus power. From time to time the water should be changed. The electric charge must also be ducted away otherwise it can act as a brake in front of the nozzles.
3. A further gain in power results from the removal of frictional losses in the whorl-pipes. If the water is in-rolled through the special profile of the whorl-pipe, it is released from the pipe-walls and forms a water plait like and inward-screwing water column. Experiments of this nature were carried out under Viktor Schauburger's direction at the Technical University of Stuttgart.<sup>6</sup>
4. Due to the rapid rotation of the rotor, centrifugal forces arise. The accelerated water in the whorl-pipes is thrust against the fluted outer wall of the machine. The ends of the whorl-pipes are curved in the opposite direction to the actual direction of rotation. A recoil is created similar to that in the abundance-producing wheel. This recoil develops energies similar to those in tornadoes. It should be mentioned that cooling takes place during the densation process in the whorl-pipes, and the 'cool eye' of the water-tornado sucks up water as tornadoes do cars, houses and locomotives.<sup>7</sup>  
Aloys Kokaly, Implosion Magazine, No. 57, pp 28-30

<sup>6</sup> See Popel Report and Preamble on p. 219 of this book. — Ed.

<sup>7</sup> In a letter Viktor Schauburger wrote that every tornado would collapse into itself, if one could manage to warm up its 'cold eye', i.e. the tip of the tornado. Aloys Kokaly, Implosion Magazine, No. 57, p. 27. — Ed.



With appropriate minor structural alterations the implosion-machine (suction-turbine) can be used for a variety of purposes.<sup>8</sup>

1. For the generation of free energy in any quantity, whereby the water used to fill it is converted into noble water.
2. As a generator for the achievement of manifold increase in growth. If embedded in the ground, the energetically charged water radiates growth-enhancing forces down into the earth.
3. For obtaining individually constituted noble waters, which charge up the body cells, dissolve deposits and reduce inflammation.
4. For the propulsion of aircraft, which can never malfunction and crash.

The great difficulty thus far was the manufacture of the whorl-pipes themselves and the dynamic balancing of the rotor for the necessarily high rate of rotation.

The machine consists of a cylindrical pipe (see figs. 20 & 21), whose diameter and wall strength must be suited to the desired performance. The bottom plate, which also has a stable base fitted, is welded or riveted onto the cylinder. The plate carrying the motor, the dynamo and the whorl-pipe rotor is fixed to the top end of the cylinder with angle brackets. All three components rotate on a single, common axle. Because the carrying plate is mounted on rubber vibration pads, the axle takes up all the vibration and permits both high and highest rotational speeds. The rotor itself is hollow and houses the real heart of the machine. In the upper part of this hollow body a hub is attached from which the whorl-pipes project. This hub is an enclosed hollow form. It is attached to the rotor and turns with it. On its underside there is an opening for the intake of the suction-pipe. It extends deep into the lower part of the machine where the drive-water is present.

The whorl-pipes are conical and various types of jet-nozzles can be fitted to the ends (see figs. 29a & 29b) The tips of these nozzles are turned towards the direction of rotation. Opposite the exit openings and attached to the periphery of the cylinder, a harmonica-like sheet-metal band is attached. It is against this that the water jets are impelled at a wide angle. The rotor is then forced to move in the direction of rotation through the resulting recoil and is thus set in rotation.

As soon as the motor has set the generator and rotor in motion, the air or water will be sucked up the suction or rising pipe and into the rotor hub and centrifugated down the whorl-pipes. A vacuum is thereby created, which lifts the drive-water like any pump.

The centrifugally impelled water, on impact with the sidewalls, would begin to flow in a circular path and all the water would remain at the outer wall. To prevent this, radial baffles must be installed to calm the water and conduct it back to the suction-pipe.

<sup>8</sup> Either as a Repulsator or a Repulsine. — Ed.

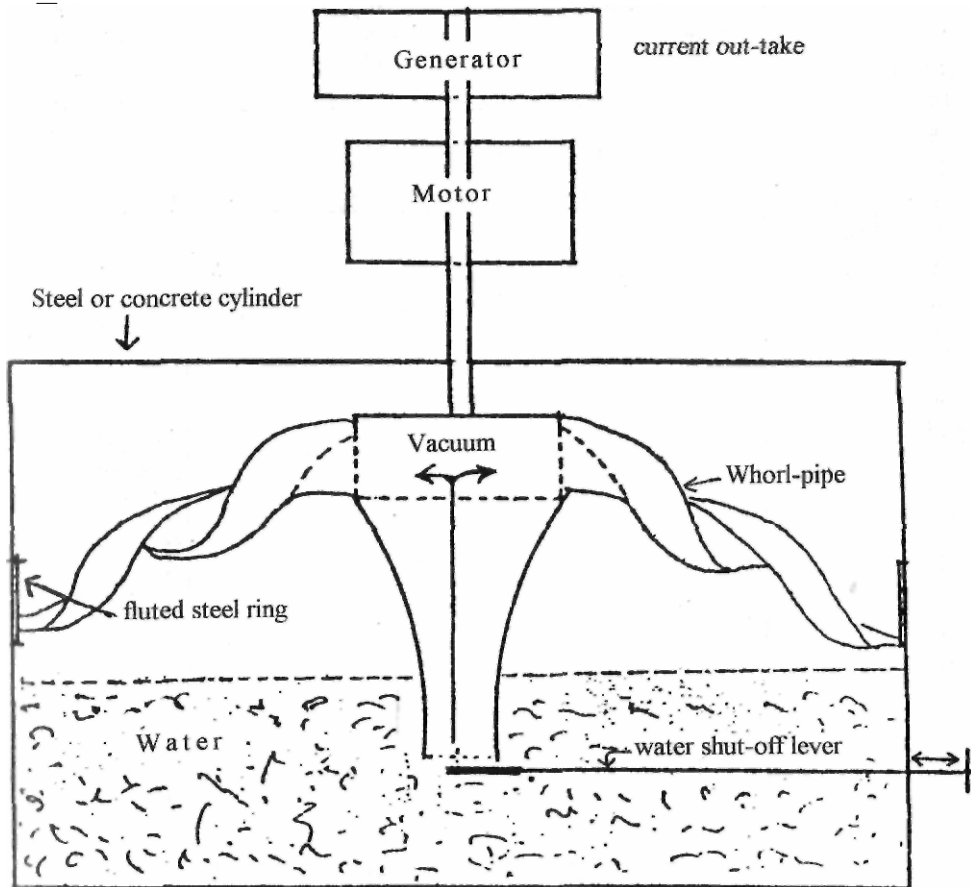

### The Water-driven Implosion Machine (design principle)

This machine produces additional torque, which relieves the load on the electric drive-motor and drives the generator. Since the generator produces more power than the drive-motor requires, the drive-motor can be powered by the generator. According to Schauberger's concepts, the generator ought to produce ten times more power than the drive-motor needs, i.e. there should be a nine-fold surplus of electric current; the whole arrangement representing a form of perpetual motion. (A. Khammas - Implosion No. 83, p.21)

Fig. 20

In order to control the quantity of water used, a flow restrictor must be placed at the bottom of the suction-pipe. Its purpose is to regulate the flow so that the machine does not rupture and at the same time controls the rate of rotation of the machine.

Aloys Kokaly, Implosion Magazine, No. 60, pp 3-5.

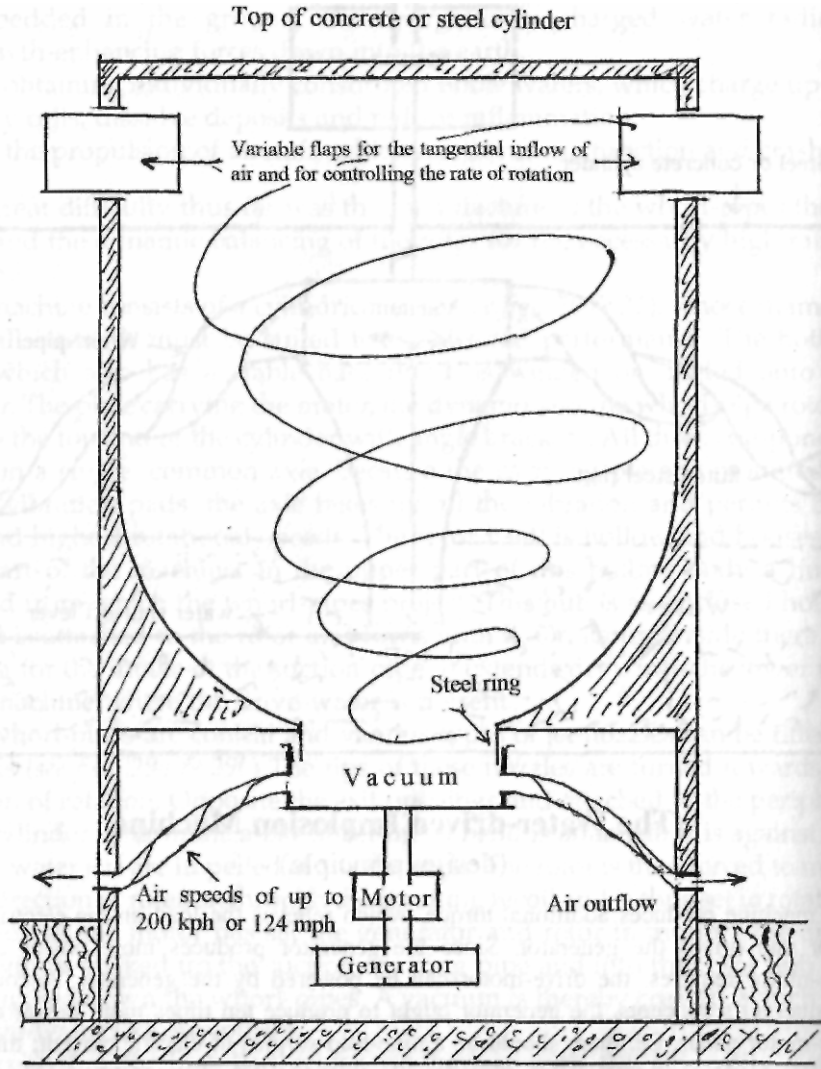

The Air-driven Implosion Machine  
(Tornado-machine - design principle)

Fig. 21

In the implosion machine, several whorl-pipes are incorporated. These have an egg-shaped cross-section, narrowing conically towards their ends and which have an impressed indentation over their whole length, by means of which the 'in-rolling' of air or water is enabled (see fig. 18). The narrowing of the cross-section occurs harmonically (proportionally), the exit nozzles can be of any size and the pipes of any length. In the implosion machine, several pipes are mounted on a conical rotor and radiate outwards from a common inlet. Through the rotor's rotation, the medium in the pipes (water or air) is subjected to centrifugal acceleration, resulting in its split-second in-rollment, which leads to its cooling and densation. Through the discharge of this condensed and twisted water-plait, powerful repulsive forces are generated, if the water-plait is centrifugated against the fluted outer walls. This recoil is the driving force.

The principle involved in this process is that, due to the cooling during the reduction process, the oxygen becomes bound by the fuel (water or air) in the implosion machine, which produces a reduction in volume. The water and air then sink resistancelessly into the resultant suction. This implosive process is the exact opposite of explosion, today utilised everywhere.

Aloys Kokaly, Implosion Magazine, No. 83, p. 15.

In this machine an additional rotational force is created, which reduces the load on the electric drive-motor and drives the generator. Since the generator produces more power than the drive-motor requires, the drive-motor can be powered by the generator. According to Schauberger's concepts, the generator ought to produce ten times more power than the drive-motor needs. In other words, there should be a nine-fold surplus of electric current. This occurs due to the fact that in specially constructed and (copper) alloyed devices protected by patents (inverted propellers - whorl-pipes), ordinary air is caused to move above the speed of sound almost silently and virtually without cost. This results in the total collapse of the structure of the air, leading to a so far unknown energy-form, and through this, to any desired intensifiable form of heat or cold, or it is possible in this way, with the aid of the above form of energy, to generate silent, fire-less, mechanical power.

Aloys Kokaly, Implosion Magazine, No. 83, p.21.

What does 'emulsion' mean? It is the intimate intermixture (marriage) between bipolar basic elements. Whether this union actually takes place, is dependent on the nature of the catalyst.

In order to obtain a high-quality emulsion, three factors have to be taken into account:

- (a) The mechanical involution of mass with the aid of specially constructed and alloyed whorl-pipes. This in-swirlment of mass has to take place in a geospheric environment.
- (b) The physical (specific) densation of the trinity of the solid, liquid or gaseous media to be accelerated, i.e. earth, water and air.
- (c) The procurement of the secondary radiation of energetic essences from involuted (inwinding) whorl-pipes constructed with bipolar alloys. These generate suction-vortices in the moving mass, whose narrow ends projects downwards. Upwardly whirling pressure-vortices then evolve, which flow back into the suction-vortex. It is a metabolic cycle moving in cycloid-spiral-space-curves in an endless screw-form motion. Expressed even more clearly, it is a motion within and about itself.

Once again it is to be stressed that all this has to take place in a geospheric environment. This first results in a condition of indifference, in a transitional state from which what is to be regenerated can be raised one stage higher in the process of synthesis. A preponderance of bases is created, which restores the over-acidified and the regenerated to a state of health. As a result, they can then reproduce and upwardly evolve with their own forces and energies, i.e. increase and ennoble themselves.

The products of this implosive process have no spacial magnitude and thus create a biological vacuum in the fermentation vessel. A biological vacuum is the function of a mass of earth, water or air having a predominantly magnetic charge. It is the metaphysical ur-force of life.

This primordial, yet new form of life, which overcomes all physical weight and mental inertia, can be produced for virtually nothing in every natural-ly designed and alloyed liquid-manure pit within a week.<sup>9</sup> When these energies ascending autonomously from the vegetation intermix with direct rays of light and heat, they coalesce into further physical growth.

Viktor Schauburger, *Implosion Magazine*, No. 45, pp 6-7

In Nature everything is reversible. If a metabolic interaction is triggered off implosively, it produces the relatively highest-grade upsuctional forces (levitation), which alleviate all mental torpor and negate all physical weight, as they also do in the case of the stationary trout.

This can all be achieved with the implosion-machine, which unwinds, rewinds and converts excess atmospheric pressure into a concentrative negative pressure. With these naturally engineered differences in potential it is possible not only to produce the driving forces for all growth, but also for powering these properly constructed, alloyed and insulated machines.

<sup>9</sup> See figs. 10 & 12 in *The Fertile Earth*, Vol. III of the Ecotechnology series. - Ed.

themselves almost free of cost. These implosion-machines can also generate those energies on a large scale that come into being when we breathe, the result of which is etherealised food.

Viktor Schauberger, Implosion Magazine, No. 57, p. 5.

In this case biomagnetism, the attracting and indrawing breathing force, evolves by up to 90%. It supplies the life-motor as well as the implosion-machine with atomic suctional and pressural forces of the relatively highest efficiency. The 90% concentrative reactive forces serve creation and growth. The remaining 10% of decentrative surplus energies serve to expel waste and faecal matter, which in this process of reduction and purification, must quickly be ejected in order to prevent self-toxification.

Viktor Schauberger, Implosion Magazine, No. 56, p. 30.

All power-generating machines, regardless of the system with which they operate, must conform to this principle: Useful energy can only be obtained from a system, if the machine triggers off a change in the temperature of the through-flowing substance.

Started by an impulse-giving motor, the implosion machine sucks in the surrounding air and water masses and reverses their polarity through a tangential, predominantly radial->axial, in-winding motion. In this way the diamagnetic, negative pressure comes into being. It is this negative pressure, that forces us to inhale positively supercharged air.

This negative pressure produces a drop in temperature, resulting in the densation of the introduced water or air masses, which in turn results in a significant reduction in volume. This acts so strongly that, for example, the inducted air is transformed into water. The process is induced through the special shape of the spiral suction device, in which the through-flowing material is accelerated towards the bottom, in which process the special alloy also plays a role. The indrawn water-masses instantaneously attain the anomaly point of +4°C (39.2°F). They become specifically densified. Homogenised by the spiral suction systems, the through-flowing material separates itself from the walls of the whorl-pipe. Through the intensification of the inwinding force and the simultaneous narrowing of the flow-through profile, the contents will be accelerated to such a degree, that the water or the air is screwed together into an almost homogenous jet and shoots out of the special system of nozzles as if from a gun. The through-flowing material attains an intrinsic velocity of 1,290 metres (4,232 ft) per second. This is about four times the speed of sound. The discharge opening has a diameter of 1 mm (0.04 in.). This jet of water or air is as solid and as hard as steel wire, and is braked periodically by means of fixed, flat (angled) resistances, which results in a reactive recoil in the direction of the turbine's rotation. With a 1 mm (0.0394

in.) diameter jet outlet, energy is produced in the order of 17.9 horse power (hp) per jet, which maintains the turbine at 1,200 revolutions per minute (rpm). Every nozzle has 2 or 4 exit openings and in one system up to 100 nozzles are possible. If each opening discharges 1 litre (0.264 gal) of water - within a fraction of a second - in the opposite direction to the above direction of braking, then atomic repulsive forces become free and active. With a total quantity of 10 litres (2.64 gal) of water, which circulates in this system without any resistance in cycloid spiral space-curves at supersonic speeds, then forces of almost astronomical power become active. If the air is liquefied, then the efficiency is considerably increased, because the reduction in volume is even greater than with the densation of water. The difference in potential increases with the number of rpm. By altering the rpm, the output can be changed significantly. For example, in order to achieve an output of between 50 and 100 hp, a turbine measuring 60 cm x 60 cm (24 in x 24 in) with a total weight of 30 kg - 50 kg (66 lbs - 110 lbs) and a rotational rate of 1,200 rpm would be required. For this neither pressure gradient nor pressure pipe is necessary. The turbine extracts its driving water from the surrounding air itself. Since the effective output increases with an increasing rate of rotation, which in addition necessitates an enlarged radius, all that is needed is to increase the starting velocity in order to produce upwards of 1,000 hp from a turbine normally producing 100 hp.

Letter to Prof. Dr. h.c. Werner Zimmermann circa 1950, Viktor Schauburger, Implosion Magazine, No. 56, p. 4.

If water or air are moved centripetally, i.e. radially->axially, then not only is there no resistance, but the output increases by the square of the velocity.

Viktor Schauburger, Implosion Magazine, No. 83, p. 15

In his theories, Viktor Schauburger proceeds on the basis that the spiral-shaped suction whorl-pipe itself can generate any amount of energy automatically. The implosion machine is supposed to generate so-called 'diamagnetism', and in this way is simultaneously stimulated into a sort of 'breathing', through which its uninterrupted operation is achieved.

A. Khammas, Implosion Magazine, No. 83, p. 15.

Schauburger applied this perception to all his deliberations and conceived flying discs, submarines, gas purifying and energy-generating systems. The component of his bio-technical submarine (see fig. 22) consisted of bundled 'whorl-pipes', which narrowed and in-rolled the water, the combined effect of which produced a powerful repulsive vortex.

What made Schauburger's principle so problematic, was 'the skill' of finding those curves wherein the water separated itself from its conducting walls,

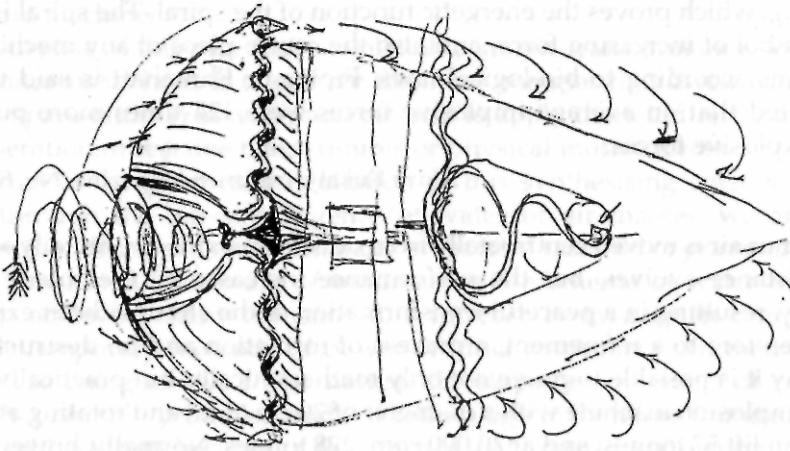

Probably the first sketch showing the design principle for a biotechnical submarine powered by a trout turbine (undated)

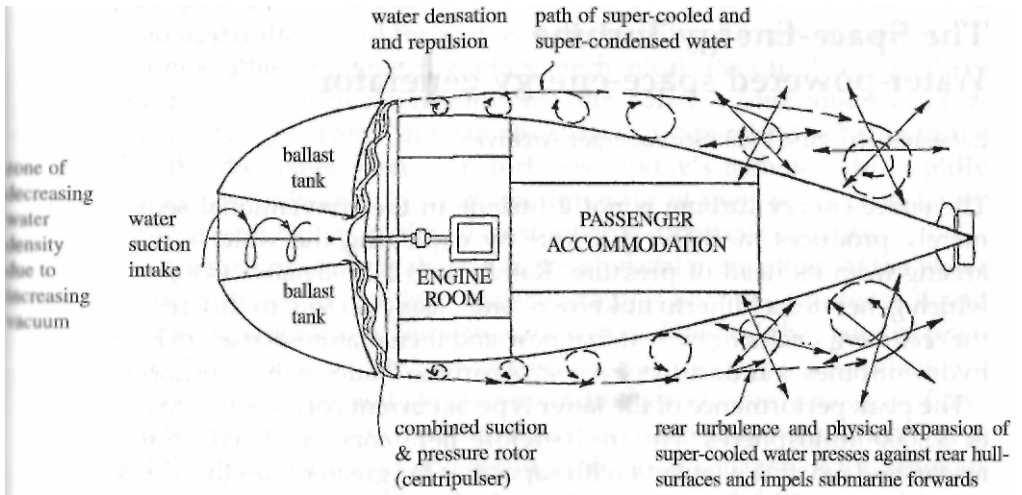

The Bio-technical Submarine  
(Design principle)

Fig. 22: Bio-technical submarine



thereby becoming increasingly dense, but without any resistance, centripetalised and thereby cooled. During this process the moving water evolves into a 'suction piston', resulting in an increasing densation from winding to winding, which proves the energetic function of the spiral. The spiral is hence the symbol of increasing force, and also the centre-piece of any machine that functions according to bio-logical laws. Professor Ehrenhaft is said to have calculated that on average implosive forces were 127 times more powerful than explosive forces.

Aloys Kokaly, Implosion Magazine, No. 83, p. 14.

If water or air is moved centripetally from outside inwards, i.e. radially->axially, no resistance evolves, but the performance increases by the square of the velocity, resulting in a peaceful transformation of the atom without explosion and therefore to a refinement, a process of formation and no destruction. In this way it is possible to prove not only mathematically, but practically, that a small implosion machine with a diameter of 20 cm (8 in) and rotating at 10,000 rpm, can lift 57 tonnes, and at 20,000 rpm, 228 tonnes. Normally, however, one would use smaller rotational forces and enlarge the radius.

Leopold Brandstatter, Implosion Magazine, No. 60, p. 23.

## The Space-Energy Turbine Water-powered space-energy generator

Leonstein, August 1945 (Schauberger Archives)

The space-energy turbine is not a turbine in the conventional sense, which merely produces mechanical torque by exploiting the water's momentum arising from its head of pressure. Rather, it is a bio-dynamo (see figs. 30->33), which generates a hitherto unknown synthesising current, to differentiate from the cavitating, analysing current that now and then manifests itself in high-speed hydro-turbines and destroys even steel turbine blades within a short time.

The peak performance of the latter type of current corresponds to a pressure of 32,000 atmospheres. We are therefore here concerned with hitherto un-researched reactive elements with capacities far greater than those developed in conventional hydro-turbines through the forces arising from the water's mass-momentum.

The types of current first mentioned arise from the bio-centrifugated inner constituents of water or air and are therefore space-energies. These are freed, for example, when high-grade (metal and/or quartz bearing) pebbles rub against one another, or manifest themselves as strong light effects in vacuum tubes, when a drop of water free-falls in an appropriate apparatus. These

energies can act destructively or creatively and can be produced almost without cost and developed to any desired magnitude by means of mechanical impulsive forces derived, for example, from the mass-momenta of water in miniature machines.

The purpose of this practically exploitable atomic transformation, which is what concerns us here, is to set free the inner energies that dwell within the bodies (space-lattices) of water and air, and to apply them indirectly towards the generation of reactive temperatures or physical motive forces.

In terms of the practical exploitation of this synthesising current, which arises through the bio-centrifugence of water or air masses, we are here concerned with the peak performances of reactive suctional or pressural forces, whose generation makes use of minimal mass-momenta of water or air in order to achieve a many thousand-fold increase in capacity in comparison with contemporary methods of power production. Apart from their cheapness, these energies also foster natural development. In terms of the way power is presently produced, today's technology is therefore founded on an unnatural basis and because of this, increasingly disastrous economic recessions must inevitably occur, the broader the scope of this totally unnatural method of generating energy. In other words, this must happen due to the extent to which the intensity of this development-inhibiting and expensive system of power production is magnified in wrongly designed and constructed apparatuses and through equally unnatural forms of motion.

Apart from a rather uninteresting rotary mechanical effect applied directly to turbine propulsion, which can result in the immediate or subsequent appearance of the cavitating current (this can also attack or demolish the banks in the vicinity of the discharge from such turbines), today's turbines also rapidly discharge the groundwater. In short, the intensity of their power constantly increases, thus provoking an almost unstoppable economic collapse.

Space-energy turbines only make use of the physical momentum of the water as an impulsive force to enable the space-energies contained in these liquid dynagen concentrations to become free and active. How this happens in practice is that, through centripetal inwinding (impulsive) processes, which are immediately followed by centrifugal outwinding (expulsive) processes, flow-through velocities are achieved, which have never before been attained. These far exceed the speed of sound and result in the total collapse of the aqueous flow-through substance, leading to processes of atomic formation and transformation, which evolve on a common longitudinal developmental axis.

This involves an upflowing bio-magnetic current with formative and levitative functions. It is thus a means of enhancing the whole spectrum of growth and increasing the upwardly impelling (levitative) force associated

with it. In other words, it is the means to foster the evolution and increase of the 'ur-powerfully creative' motive force and to intensify its power to such a

degree that free and independent movement can be achieved on land, on and under water and in the air at any desired speed virtually free of cost.

While in the best machines produced today the resistance to motion increases by the square of the velocity, with the aid of these reactively intensified energies, whose power increases by the square of the increase in rotational velocity, there is about a 90% saving in the driving medium as well as about a 60% reduction in construction material, for under otherwise equal conditions, the 60% smaller space-energy turbine has the same capacity as a large conventional one. Whereas the principal reactive force produced by the latter is the cavitating current, the former generates the synthesising current, which by indirect means can not only can produce any desired output, but on top of this, development-enhancing higher-grade im-pulsive and ex-pulsive energies.

Briefly, this would signify not only the almost costless and labour-free solution of today's problems of food supply, but also those of power, fuel and raw materials, which are the biological consequences of completely back-to-front methods of power production.

In more graphic terms, humanity has mis-earned its daily bread by the sweat of its brows through unnatural methods of producing those energies that Nature employs for purposes of decomposition and the precipitation and reconstitution of what is unfit for further development.

## 8.

# The Ennoblement of Water

"The revelation of the secret of water will put an end to all manner of speculation or expediency and their excrescences, to which belong war, hatred, impatience and discord of every kind. The thorough study of water therefore signifies the end of monopolies, the end of all domination in the truest sense of the word and the start of a socialism arising from the development of individualism in its most perfect form."

Viktor Schaubeger, - Implosion Magazine, No. 6, p. 29.

"The true foundation of all culture is the knowledge and understanding of water. Water is the ur-substance or ur-cause of all creation and for this reason is the ur-original accumulator, which readily absorbs both earthly and cosmic substances and conveys them to the body in a purely objective form. This is dependent, however, on the possibility of incorporating these substances in the water. This must be done in such a way that the ur-attributes will in no way be modified and that change as such can only first come about in the effect, which the organically correctly

structured body mediates and imparts. For this reason a good spirit dwells in a healthy body. Conversely a body full of vitality can be created, maintained and further developed by healing the inhering spirit."

Viktor Schaubeger, 1936, From Spec. Ed. Mensch und Technik, Vol. 2,1993, section 4.1.

## The Artificial Production of Springwater

From Spec. Ed. Mensch und Technik, Vol. 2,1993, section 7.3.

**A**s forester and huntsman I was often able to observe how sick and severely wounded animals sought out certain herbs and immersed their wounds in very particular kinds of water. Ultimately it dawned on me that very mysterious powers dwell in water and so I began to seek them. Not only did I find these remarkable forces, but I also found the means to incorporate them into water at will. To begin with I tried the product on myself, later giving this naturally activated water to a number of others to

drink. Over time there were hundreds of people suffering from all imaginable afflictions, who were restored to health. I gave this ennobled water to all of them to drink, which tasted far better than the Vienna mountain-springwater.

I have small devices in my possession with which I can determine the quality of water. The ennobled water flows through rifled pipes without touching the sides, i.e. it falls through the middle and lands on cone-shaped, metallic bodies placed below the pipes. Wires are arranged around the outer periphery, which are cross-connected. They become charged with the animalistic currents emanating from the water and conduct them to an electroscope (see fig. 23 & figs. 1->3).<sup>1</sup> One litre of water has to pass through this apparatus about 150 times before the flapping of the electroscope's foils weakens. Neon tubes glow with a rich, dark red initially, only to become brighter and brighter until the water begins to die and the light finally flickers and goes out. Consequently we imbibe hundreds of thousands of volts when we drink this healthy water, which can in no way be differentiated from a high-grade mountain-springwater. It was in this way that I discovered how to transform stale stream-water, rainwater or distilled water into high-quality drinking water.

The process is very simple. A little light, a little darkness, a little heat and a little cold, rhythmically sequenced, is enough to charge the vilest water with high quality as it flows through the mutators, a process that could also perhaps be described as 'ionisation'. To this I add the elements that chemical analysis has shown to be deficient, but which are present in all springwater and therefore the waters of any given spring, even the most famous spa-waters, can easily be emulated just as Nature does it. In this regard a cubic metre of water (35.315 ft<sup>3</sup>) only costs about 10-12 Austrian grosschen and the apparatus itself about 100 schillings if mass-produced. Therefore anyone can install their own spa or mountain spring in their attic at very little cost.

The essential nature of this concerns the achievement of an absolute solution and the freeing of the energies concentrated in the metals and minerals by means of a cold process of combustion. By virtue of this, all substances are dissolved, or expressed more accurately, fall out of the mother-stone or mother-metal in the form of freed energies, which can be incorporated into the water without undergoing any change. To achieve this, the water must be brought down to a temperature of +4°C (+39.2°F) in darkness, which takes place in interconnected mixing vessels through indirect oxygen pressures. The added salts are of such minimal quantity that it is inconceivable to anyone that effects of such a kind can be produced. An essential aspect in this regard are the solutions of the metallic substances, which are accumulated in the water and thus in the simplest way these contrasting metals are

<sup>1</sup> This also relates to the effects of Lord Kelvin's influence machine ca. 1880. - Ed.

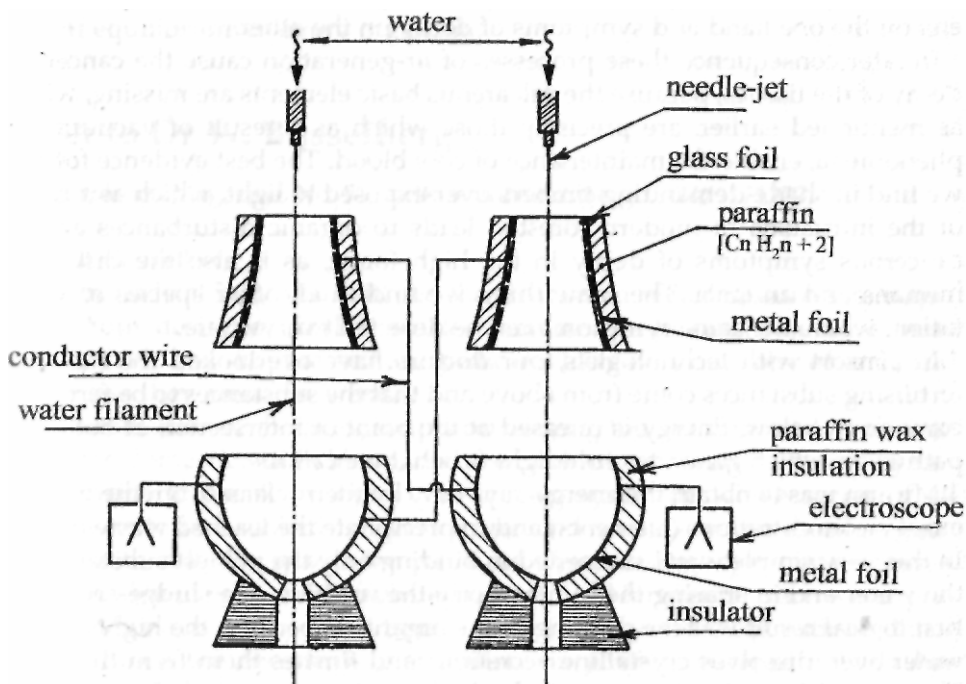

Schematic Arrangement of the Nuremberg

#### Water-Jet Experiment- 1938

This was set up to determine the charge in falling water as well as water quality. Charges of 15,000 - 20,000 volts were produced.

Fig. 23

transferred to the organism, without which there are no electromagnetic life-processes.

Every acid contains dissolved metal. Through the intake of over-insolated water, the heavy long-rays enter the water in excessive measure and the light short-rays are missing.<sup>2</sup> This leads to symptoms of inflammation, because the supply of the inflammation-inhibiting calcareous<sup>3</sup> elements is prevented by present methods of water treatment. The consequences of these deficiencies are intermediate growth-processes of purely morphological nature which, exposed to the effects of pressure, produce large capillary diameters. Symptoms of fatigue then follow as a result of undernourishment. With an

<sup>2</sup> Heavy long-rays = long-wave infrared radiation: light short-rays = short-wave ultraviolet radiation —

Ed.

<sup>3</sup> Calcareous: containing or resembling calcium carbonate. — Collins English Dictionary. — Ed.

over-abundance of sodium emanations, these give rise to animating phenomena on the one hand and symptoms of decay on the other.

In later consequence these processes of ur-generation cause the cancerous decay of the tissues, because the calcareous basic elements are missing, which as mentioned earlier, are precisely those which as a result of vacuum-like phenomena, enable the maintenance of cool blood. The best evidence for this we find in shade-demanding timbers over-exposed to light, which as a result of the intrusions of modern forestry, leads to organic disturbances and to cancerous symptoms of decay in the high forest, as is also the case with humans and animals. The same thing we find in all other species of vegetation, where the same symptoms can be detected everywhere.

In consort with technologists, our doctors have overlooked the fact that fertilising substances come from above and that the substances to be fertilised come from below. Energy is released at the point of intersection of both ray-pathways, which generates cold light or what we call life.

My aim was to obtain the energy-rays only by their release from the various energy-concentrations (elements) and to precipitate the leached waste matter. In this very simple way I succeeded in binding only the noblest substances in the water and in sparing the human body the function of a sludge-sack. The first logical result was the purging of the organism, because the highly active water even dissolves crystalline accretions and flushes them from the body. The second logical outcome was the high-grade organic transformation of emanations and therewith the synthesis of those high-grade thoughts with which all other natural processes can be comprehended.

The main point, however, is that no high-quality ideas can emerge from a messy sludge-sack and therefore it is no wonder that humanity is not only putrefying healthwise, but also morally. Mutilation of the mind is a further logical result of contemporary deductive methods and even here too, outsiders must dare to venture in order to make the specialists and experts aware of ur-simple, natural phenomena. No process is of one-sided nature. All progress also involves wastage. The waste material produced by the formulation of thoughts are seeds. Therefore with their present view of life, people will not only become mentally impotent, but sexually impotent too.

Through the combined action of certain interdependencies, organic effects can be induced in the body. Very recently I dissolved the dynagens contained in purest rock crystal and then accumulated the freed radiant energies in the water. In this way I managed to produce ur-proteins or life-kindling vitamins. Our food should be viewed as bio-electrical energy. The consumption of water in which many solar-vitamins of reactive nature have been incorporated, creates pleasant symptoms of fatigue, followed by a freeing of mental powers and a certain carefreeness coupled with a rising sense of responsibility. It is necessary, however, to differentiate between calcareous and sodium-containing

foodstuffs. The binding of ur-substances in water brings about a harmonious state of equilibrium in every organism.

## Letter to Dr W. Busselberg

From Implosion Magazine, No. 71, written in Nuremberg 18-24/11/1937.

Dear Dr Busselberg,

In the periodical TAU you will see the treatise on water resources management.<sup>4</sup> Your desire for further articles I am unable to satisfy, because these writings have been suppressed everywhere. I have only one copy of each, and in any case they are all in Vienna. The publication of the manuscripts concerning the decomposition of drinking water, domestic water, blood, and the cause of cancer are so alarming that it is unwise to speak of them here in Germany. The whole secret of all scourges is to be ascribed to over-oxygenated water - water that has been treated with chlorine, quartz lamps, or subjected to oligodynamic processes. When combined with anodic substances (artificial fertilisers), such water produces bacteria in a very short time. I have furnished doctors with evidence and set down the necessary interrelations in writing, because nobody has dared to publish the true causes, otherwise almost all drinking water supply-pipes would have to be rebuilt. Equally inevitable would be the prohibition of the fertiliser industry by law. In other areas of industry drastic changes will also have to take place. For this reason there will hardly be any possibility to discuss this openly in the foreseeable future.

My discoveries are so far-reaching, that everybody would be reduced to a state of terror. I have therefore no other choice, but to bide my time and continue my research eventually to be able to provide information and advice, when those in authority no longer see any other way out. In my estimation this moment will already come early next year. I am ready at any time to furnish free information, proofs and means of assistance to competent persons. Naturally in doing so I cannot afford any large outlays, because as a foreigner I have none or only a few marks to my name. These are just sufficient to allow me to finish the work I started here. In any event, I have to acknowledge that it takes a lot of courage to listen to what I have to say. When I find such individuals, then it will be possible to provide effective assistance. If not, then there will be much vexation.

At the moment I am building an apparatus with which I will demonstrate the processes of growth and in particular, the enormous importance of the

<sup>4</sup> See series of articles on river engineering written by Viktor Schauberger for 'DieWasserwirtschaft', the Austrian Journal of Hydrology, which appear in The Water Wizard, Vol. I of the Ecotechnology series. — Ed.



growth-zones in the Earth. Moreover, I will provide proof that the cause of all cancerous diseases is due to the direct influences of atmospheric oxygen. Atmospheric organisms can only obtain oxygen by way of diffusion (indirectly by passing through another medium), otherwise pressure, combustion, inflammation of the tissues, blood-, water- or sap-decomposition ensues. Bacteria are only of secondary importance. Every type of blood, water and sap has its own individual bacteria. In Nature there are indeed similarities, but no identicalities, for in Nature there is no state of equilibrium.

Water is not  $H_2O$ , but the first substance arising from the harmonious interaction between plus and minus (quantity and quality). The ur-cause of natural motion is the interchange of substance (metabolism). Whoever causes substance to move without taking the metabolism into account will also have to accept the associated resistances to motion. A motion triggered through metabolic processes is natural and therefore resistance-less. Here too we stand before an upheaval with technological ramifications. The associated proofs, apparatuses, etc. are now complete. Present practices in land, forest, water and energy resources management are absolutely wrong. Germany stands before a catastrophe in the foreseeable future, because the water is disappearing and the groundwater is sinking. Atmospheric water has nothing whatever to do with geospheric water. The scarcity of rainwater is not the reason for the disappearance of springwater, because the latter is produced through geospheric metabolic processes.

You must apply all your influence to this, for it concerns the fate of Germany. I stand completely behind my assertions and can prove all that is stated above. I honestly mean what I say and have the best of intentions. I know Nature and her secrets, more perhaps than any other person alive.

## Blood & Sap Circulation as a Model for the Ennoblement of Water

Leonstein, 28th May 1945, - Implosion Magazine, No. 124, pp 56-58.

Up to now no-one has succeeded in discovering the origins of blood and sap circulation, or in explaining the purpose of this metabolic cycle. The assertion that the heart is a blood-pump is inadequate for the simple reason that the primary question still remains unanswered, namely, what forces keep the heart muscle pulsating? A trifling infection of the blood is enough to alter the heart's activity, to make the pulse-beat irregular and to disturb the state of health with feverish conditions. For this reason alone it becomes clear that it is not the heart that moves the blood, but the blood that activates the heart.

To understand this, the nature of the blood, the causes of its coming into being and the reason for its passing away must be examined more closely.

The cause of its formation is 'cycloid-space-curve-motion', which is to be understood as inwardly and upwardly inwinding spiral cyclical motion. This is characterised by the fact that, with even the smallest impulses the substance rotates about its own axis, which gives rise to the rhythmical alternation between centrifugal and centripetal pulsations on a common developmental axis, resulting in the creation of an alternating current flow. This organic alternating current is the actual motivating force behind the movement of blood and the activity of the heart caused by such movement. An analogous proof of this is the emergence of pulsation in naturally moved water.

The heart is therefore a kind of compensating valve into which the discharged (venal) blood flows back and satiates itself with products of digestive processes. This mixture is then supplied with fertilising substances (oxygen) through breathing; in other words, the former consumes (binds) the latter. The products of the repulsive further movement of the blood are conformations that have been developed to the immediately higher aetheric and energetic state. Due in part to the influences of heat and diffuse light, these agglomerate as new blood masses and subsequently solidify into the physical substances of growth. It is out of these secondary products of synthesis that the build-up of primary synthesising substances takes place, namely, forms of energy which interact with the surrounding potentials and in this way generate the body's physical energies - its capacity to carry its own weight and its ability to move.

In principle it is the same process that can be observed in all plants, where the root-protoplasm is the source of negative potential through which fertilising interactions with positively charged atmospheric substances occur. Again, through the direct influences of light and heat, this leads to the inner condensing of the lower-grade products of these interactions and therefore to the layer-by-layer formation of the solid forms of plant bodies - in other words, to physical growth. The motion arising from physical impulses therefore leads to metaphysical formative motion, and in further consequence to an increase in performance.

Provided the appropriate temperature influences, namely the oligodynamic (dissociative) and catalytic (formative) ancillary influences, can take effect, then a small impulse triggered off in a naturally contoured and alloyed vessel will suffice to enable droppable<sup>5</sup> liquid or gaseous mixtures to be transformed and built up into the next highest state of evolvment (aetheric and energetic forms). On their part, these are responsible for further processes of reproduction and development, the increase in physical substance and the enhancement of metaphysical qualities.

<sup>5</sup> Droppable: refers to liquids or gases capable of agglomerating into drops when falling. — Ed.

In principle the same transformative and formative processes take place in the human and animal organism. These stimulate respiration which in turn provides for the supply of fertilising substances, and once again the next higher products of development, aetheric and energetic, are created, which are the actual source of energy for the physical and metaphysical motive forces.

It is upon this finding that the ennoblement of the blood of the Earth - the negatively charged groundwater - is founded. This cannot only be produced in unlimited quantity, but also increased and qualitatively ennobled, provided the developmental processes described above are copied naturalesquely. Once again, the true secret of evolution lies in the cycloid motive impulse triggered off in naturalesquely formed vessels - extreme egg-shapes.

Following from the above, it is obvious that the proper proportion in the mixture between the substances of the Earth and the Sun (carbones and oxygenes) is also decisive.

This system of blood and sap circulation, faithfully copied from nature, enabled the high priests of bygone cultures to produce artificial high-springs in which water rose exuberantly to the highest mountain peaks, where the sacred groves were to be found. In these groves the holy or healing water gushed forth - the higher up it discharged, the greater its wholesomeness. The lengthening of the developmental path along the longitudinal axis was one of the most closely guarded secrets of the nature-attuned high priests, who were regarded by the populace as miracle-workers. They increased the growth of high quality cereals and fruits and enhanced harvest yields simply by moving water rhythmically about the transverse and longitudinal axis and about its own axis cycloidally in naturalesque development-facilitating vessels under the exclusion of light and heat. Moreover, they knew the recipes for the mixtures, which similar to those in human or animal bodies, are the products of inorganic digestion. As inwardly and outwardly oscillating formative essences arising from the 'cycloid movement of the Earth-masses', these products are respirated and supplied with fertilising substances (oxygen) on their formative path and explain the profound secret of genesis and growth, as well as the latter's ennoblement. In this way it is therefore possible not only to produce large quantities of water, but also to ennoble it.

Therefore the possibility now exists not only to transform seawater into drinking and domestic water at an atomic level, but also to establish new and almost limitless cultural communities even in waterless wastelands. That 'specific' healing is also possible with this noble water will be addressed in another chapter and explained in greater detail. The devices for demonstrating these processes are located at the moment at Rudolf Zeitlinger's scythe factory.

What we are therefore here concerned with is the rediscovery of the secrets of age-old cultures, with which it is possible to improve the tragic world situation. To restore to all humanity almost absolute freedom from hunger, as

well as almost absolute freedom of movement on land, in and under water, and in the air.

## Petrol (Gasoline) From Water

From Spec. Ed. of Mensch und Technik, Vol. 2, 1993, Section 9.0 (Notes from January 1936).

Take a well-insulated, preferably egg-shaped vessel made of clay or failing this, an oak-barrel, which as far as possible shields against the influences of external temperatures, but which neither impedes the respiration of the vessel, nor disturbs its diffusive functions. A three-element jet-impeller is rotated (screwed into the water) inside the vessel, the upper portion being made of copper and the lower of a metal of opposite polarity, such as silver.

The openings themselves must of as small a bore as possible and of a screw-form configuration, so that on the one hand the mechanical coherence of the gases forced through under the highest practicable pressure is guaranteed and on the other, a very strong atomisation takes place, when the gas exiting from the lower nozzle enters the upward-curving egg-profile under a strong drop in temperature. The surfaces of the systems of jet-nozzles are reciprocally configured dimensionally. The three nozzle-openings narrow towards the exit-opening in the same ratio.<sup>6</sup> The lower series of nozzles is half the size of the upper. Immediately above and below the two thrust-producing elements, which must be well-insulated externally, adjustable thrust deflectors are mounted inside the egg-form, which can be set closer together or further apart in order to be able to regulate the evolving differences in potential. These thrust-emitters are also to be insulated externally, so that the direction of their respective electrons is safeguarded. They must also be made of bi-polar metals; the simplest solution being to silver-plate the copper elements or to put a layer of copper-oxide on the silver components.<sup>7</sup>

The most essential aspect in this regard is that these elements begin to emit rays under the reciprocal influence of temperature and that an animalistic current flows. This ionisation, wherein hydrolysis<sup>8</sup> plays a decisive role by means of high-tension and complex absorptive processes, is of crucial importance for it is during these processes that the analysing and synthesising electro-osmotic events have to take place.

<sup>6</sup> The ratio here is probably that of the 'Golden Mean' or 'Fibonacci ratio' = 1 :1.618033988. — Ed.

<sup>7</sup> This appears to describe an early model of the Repulsator for which there are no accompanying diagrams. — Ed.

<sup>8</sup> Hydrolysis signifies the decomposition of a substance by the combination of one of its elements with one of those in water. - Ed.

The barrel or unglazed, earthenware vessel<sup>9</sup>, which should be as egg-shaped as possible, will now be filled with well-insolated seawater or thoroughly insolated or acidified fresh water, preferably rainwater. The successful outcome depends on the degree of solar irradiation and acidification. Lack of sunshine can be remedied by the addition of hydrogen peroxide, etc., but this does necessitate irradiation with a quartz lamp. The simplest is solar irradiation. The starting temperature of the water should be between +12°C (+53.6°F) and +17°C (+62.6°F). Into this insolated water very small quantities of silver or zinc, or copper filings should now be added. Eventually these can also be applied to the nozzle lining and around which the entering gas will flow. In this case, the particles or laminates must be small enough not to block the nozzle-openings.

The relative proportions between these two metals of contrasting polarity has to be determined empirically. In addition small quantities of brown-coal in the form of cubes, phosphates of salt, a little magnesium or other substances, such as can be found in all springwater, must be introduced into the water. These salts, however, should not have been overly exposed to daylight. As additives, sulphurated water and the addition of a little nitrate of potash increase the performance of the end product. The more varied the additives, the better and the higher the quality of the final mixture. Because the changing seasons often have a decisive effect on the whole, the relative proportions of these additives must also be determined empirically.

Once all this has been done, the vessel is then closed and sealed against the entry of light and air. Then a dash of carbon-dioxide and a dash of air or oxygen are introduced alternately, the former from above and the latter from below, but in such a way that no pressure is created in the interior.

The C-acid gas<sup>10</sup> introduced from above lowers its temperature and will be rapidly absorbed by the cooling water. Once this ionised gas mixture has been inhaled by the water, as it were, then a dash of oxygen is injected, whose dispersal must be confined within the water only, concentrating itself in the upper strata of the water. This results the development of a stratified, self-densifying, spacial structure from the bottom upwards, through which the carbone gases coming from above have to diffuse. If the process proceeds

<sup>9</sup> This shape is akin to the gulla, which Viktor Schauberg describes as follows: "The people of ancient cultures made use of the so-called 'gulla' for storing their liquids. This mysterious vessel maintains the freshness and vitality of every liquid, be it water, milk, etc. Fabricated under very curious ritualistic practices, the gulla was formed out of clay with a high aluminium content. The basic shape of the gulla was the pentagon, the ur-form into which the lump of clay was shaped before being turned on the potting wheel into the naturalesquely shaped vessel. If such a basic clay form is stood on its natural base, then the naturalesque egg-shape is created, in which the bi-fifth triangle plays a decisive role in respect to its hypotenuse and side in relation to the radius, whereby the rpm of the wheel and the resistance to oscillation of the shaping hand has also to be taken into consideration. The function of the finished vessel, with which it is known the ancients cooled luke-warm water in hot sand under the rays of the midday Sun, depends on the skill applied to these internal and external influences as the naturalesque egg-shape was rotating." *Implosion Magazine*, No. 115, pp 62-63. — Ed.

<sup>10</sup> C-acid gas: Carbonic acid gas otherwise known as carbon-dioxide. - Ed.

correctly, then an extremely strong vacuum forms in the space above the water, which atomises and cools the follow-up  $\text{CO}_2$  even more, giving rise to the necessary intensification on the one hand and the creation of the polarity between the gas and the water on the other.

Under this reciprocal intensification the introduced substances begin to dissociate, during which process the water temperature slowly drops to  $+4^\circ\text{C}$  ( $39.2^\circ\text{F}$ ). This temperature level must be maintained by injecting the gases alternately during which the pressure-gauge fluctuates slightly. This is a sign that the water has begun to breathe and pulsate properly. Should over-pressure occur, it is indicative of a progressive development of heat, whereas an under-pressure signifies a strong increase in  $\text{CO}_2$ . Here the danger of an explosion is incipient, which can be averted if the temperature of the water can be maintained at  $+4^\circ\text{C}$  ( $+39.2^\circ\text{F}$ ). This can be regulated simply by adjusting the inflow of oxygen. The addition of very small quantities of oil or other fatty-matter increases the valence of the mixture, but also the danger of explosion. For this reason the introduction of these substances is not advisable at the beginning.

If no reactions of any kind are evident, and if all the ingredients have been completely dissolved, then the mixture should be allowed to stand for about two hours, during which time the temperature must always be maintained at  $+4^\circ\text{C}$  ( $+39.2^\circ\text{F}$ ). This is most easily achieved in a cellar where such temperatures prevail. Where a good cellar is available, however, the whole thing can be simplified, because the process described above need only be inaugurated with a few alternating injections of  $\text{O}$  and  $\text{CO}_2$ . The whole can then be left to ferment, a process sufficiently well-understood in the preparation of wine or cider. In this instance, however, in the initial stages of the process, the contents should be stirred around gently with a well-insulated mixing-device on which a zinc or silver scoop has been mounted on one side and a copper one on the other. The external closure can be effected with a mercury seal or by the insertion of a compression ring.

The content of introduced  $\text{CO}_2$ , however, must exceed 90% and proportions similar to those found in the water of all good mountain springs must exist in the end-mixture, although here we are concerned with substantially different products of solution than those found in springwater. In principle, however, there is no difference between them. In this regard it is necessary for those substances that have evolved under the influences of light to be decomposed in darkness and a drop in temperature or vice versa. Through these alternating processes of decomposition, structures of alternate character are formed by mutually opposing influences. This arising and passing away is triggered artificially and reciprocally intensified until a complete solution results, ultimately arriving at the synthesis intended. With warming and having undergone an end-reaction, the finished mixture has a slight smell of petrol, but does not burn. However, if this mixture is

atomised in a needle-jet or injector and only lightly compressed by the descending piston, then an explosion occurs. We have thereby achieved what we wanted, namely a mixture of explosive water, which is an exceptionally stable and safe substance, but which produces a higher dynamic effect in the piston-engine than the product obtained through the distillation of crude oil we call 'petrol' (gasoline). Electromagnetic ignition is superfluous and by means of this process we have produced a substance that can be used in diesel-engines.

For large-scale production, this mixture is best produced in special tubes, which cool and move the seawater bio-dynamically as it flows. In this way any desired quantity can be mass-produced. Since any kind of agricultural or forestry waste can be decomposed in these tubes, this process is by far the simplest and best, for no work of any kind is required. All that is necessary is for predigested waste-matter to be thoroughly and completely fermented in seawater or salinated fresh water during the self-cooling flowing motion. The addition of turnip slices, fruit-waste, lemon peel, etc., increases the valence of the mixture, because we are here concerned with a very simple natural process, which is essentially always the same, namely that everything that has once grown, that has lived and moved, pulsates, ferments and reconstitutes and builds itself up, if the thing is merely moved morphologically and the anomaly point or life-point is approached as a result.

With every degree Celsius (1.8°F) drop in temperature, all gases cool at the expense of their volume and in this extremely simple way the dematerialisation-volume, or the 4th dimension, or the condition of pure energy is ultimately reached. In this respect it is important to differentiate clearly between the spacial structure and the volumetric structure; that is to say, that neither formative entities, nor dematerialising entities should be allowed to appear,<sup>11</sup> if one wishes to accumulate positive or negative intensifications of energy in any given liquid. This takes place at the anomaly point or point of neutrality, in which space and volume dematerialise and hence manifest themselves non-spacially as energy.

<sup>11</sup> Here the word 'spacial' can also be taken to mean 'dimensional' in that here it is necessary to achieve an intermediate state of equilibrium at the halfway point between other-dimensionality and physical volume. — Ed.

## 9.

# Machines of the Genus — Repulsator

"We need no science of formulae, but a science of forms."

Viktor Schauburger, Implosion Magazine, No. 124, p. 29.

## The Production and Advantages of Implosion Machines

Linz, 27th March 1955, From Implosion Magazine, No. 61.

**T**he Suction-turbine (see fig. 20), generally known as an Implosion machine, is as different from a pressure-turbine as night is from day. Both machines are reactors or devices which trigger off reactive forces. The suction-turbine is water-producing, whereas the pressure-turbine is water-destroying.

The pressure-turbine utilises the forces resulting from the weight of water and its efficiency rises as the available head of water or steam increases. The suction-turbine requires no head of pressure and therefore can be installed in still water. This saves expensive pressure resistant pipes primarily because it sucks in its own drive-water. In order to do this, however, it has to be set in motion by conventional means. The higher the speed of the starter motor, the greater the quantity of drive-water screwed upwards and the higher the performance. The indrawn water becomes densified mechanically and physically. The rotation of the many whorl-pipes generates centrifugal force along their longitudinal axes, which expresses itself as an evolving reactive force. The generation of these reactive, rotational forces, and therefore the performance of the suction-turbine, is dependent on the initial velocity at which the mass of drive-water is sucked upwards, densified and accelerated. This can be regulated at will according to the setting of the starter motor, which merely provides the initial impulse for the frictionless, rotational acceleration.



An engineer, who is unaware that products of reduction also exist in every movement of a medium containing bipolar sediments, will find it difficult to discern the origin of these additional rotational forces. Forces are active in the suction-turbine, which cannot be compared with those in a pressure-turbine.

The suction-turbine is also a machine for ennobling water, in which polluted freshwater can be reactivated, or seawater reconverted into mountain-spring-quality drinking water and otherwise useful water. Suction-turbines are therefore development-enhancing reactors.

The output of the suction-turbine is about nine times greater than a pressure-turbine, because no resistance is created in its system of pipes. This eliminates all competition from the pressure-turbine industry.

At school everyone learnt that the Earth has a magnetic longitudinal axis about which it rotates. In every physics book or even a dictionary it is stated that there is a form of magnetism which attracts iron, cobalt, nickel, manganese, etc. The counterpart to this form of magnetism is the organic vacuum, which draws in oxygen and supplies organic processes with it.

Also known as diamagnetism, this form of magnetism evolves when a medium with a loose-knit structure, such as air or water, is moved in an inwinding motion about its own axis. This motion leads to the cooling and reduction of the volume. The reduction in spaciality is indicative of the initiation of the adsuctional or attractive effect.

This axis is not like the shafts in all contemporary machines. The suction-turbine (implosion-machine) has no shaft, but only a hub onto which the logarithmical<sup>1</sup> whorl-pipes are attached. It is an inverted (inside-out) propeller, which centripetates the indrawn masses of air or water about their own axis and therefore inwinds them radially->axially. They trigger off the mysterious negative pressure, which Professor Sauerbruch discovered in the thorax. In 1908 his superior, Professor Mikolitsch, declared that Professor Sauerbruch was out of his mind, when the latter asserted that without this negative pressure it would be impossible to breathe. Nor would any uptake of nutrients be possible. However, Professor Sauerbruch failed to appreciate that this concerned the development of diamagnetic, reactive forces, which evolve in the self-inwinding blood and sap vessels.

New findings of research have indicated that the Earth rotates in spiral space-curves about its diamagnetic axis. This axis is no axle, but a negatively potentiated concentration of dynagen, which arises through this inwinding motion. The axis itself is something akin to a hole into which seminal substances are sucked. Had science perceived this earlier, then the suffocating death of water would never have happened. It must also be mentioned in this regard, that over-illuminated and warmed water inevitably decays.

<sup>1</sup> Logarithmical: Viktor also makes use of the 'Golden Mean' or 'Fibonacci ratio' in the construction of such pipes and their graduated attenuation in the ratio 1:0.618033988. - Ed.

Every river regulation is a crime, because the water migrates towards the riverbank owing to the cessation of its complex, curvilinear, flow pattern. Vortices are unable to develop, which suck in the oxygen like miniature cyclones and enable the water to breathe. Regression and the development of cancer then ensues.

This fact is easy to prove and can be demonstrated by all pressure-turbine systems. Indeed, the destruction of quality should be proof enough. The progressive extinguishing of the life-force daily furnishes evidence of this. Those who do not wish to travel this cancerous road, will buy biotechnical machines and appliances, in the same way they buy health products in the health food stores that are springing up like mushrooms.

## The Production of Noble Water & Drinking Water An Assembly of Pertinent Data from Implosion Magazine

The whole problem lies in the creation of breathing water using a technical appliance. First of all the water must actually be alive. For this it has to be made to in-roll and then out-roll again. If one wishes to achieve the desired potentiation of the noble water, then its previous potential must be eliminated. This happens by starting off with distilled water into which the trace elements are introduced, that are to be found in certain medicinal springs. The starting temperature is about  $+20^{\circ}\text{C}$  ( $+68^{\circ}\text{F}$ ) and the end temperature  $+4^{\circ}\text{C}$  ( $+39.2^{\circ}\text{F}$ ).  
Aloys Kokaly, Implosion Magazine, No. 51, p. 12.

If the temperature in the (springwater producing) apparatus reaches  $+4^{\circ}\text{C}$  ( $39.2^{\circ}\text{F}$ ), the 'process of cold oxidation' is inaugurated, whereby the oxygen, which becomes passive in this condition, is bound or emulsified by the hydrogen, which has become aggressive. The 'Eternally Feminine' winds the 'Masculine' into herself and allows herself to be fertilised.

Viktor Schauburger, Implosion Magazine, No. 21, p. 5.

For this purpose a little ice must be added. The apparatus holds about 11 litres (2.9 gal.) (see figs. 24-26) It is filled to the brim with water so that all air is excluded. It is then sealed, about 4 litres (1.06 gal) of carbon-dioxide impressed and about 4 litres of water drained. The appliance is then set in motion. The sucking function of the vortex evolving in the device, entrains the carbon-dioxide into the water very quickly and a vacuum develops. Under the effect of this vacuum, the various mineral and metallic trace elements become incorporated in the water. With the drop in temperature from  $+17^{\circ}\text{C}$  ( $+62.6^{\circ}\text{F}$ ) to  $+4^{\circ}\text{C}$  ( $+39.2^{\circ}\text{F}$ ) the oxygen becomes inactive, whereas the carbon and hydrogen become highly active. The water becomes hungry for

oxygen. Such water, drunk fresh, breaks down all excess acidity in the body. The over-acidified cells can then breathe again and take up oxygen. Return to health follows.

Aloys Kokaly, Implosion Magazine, No. 51, p. 12.

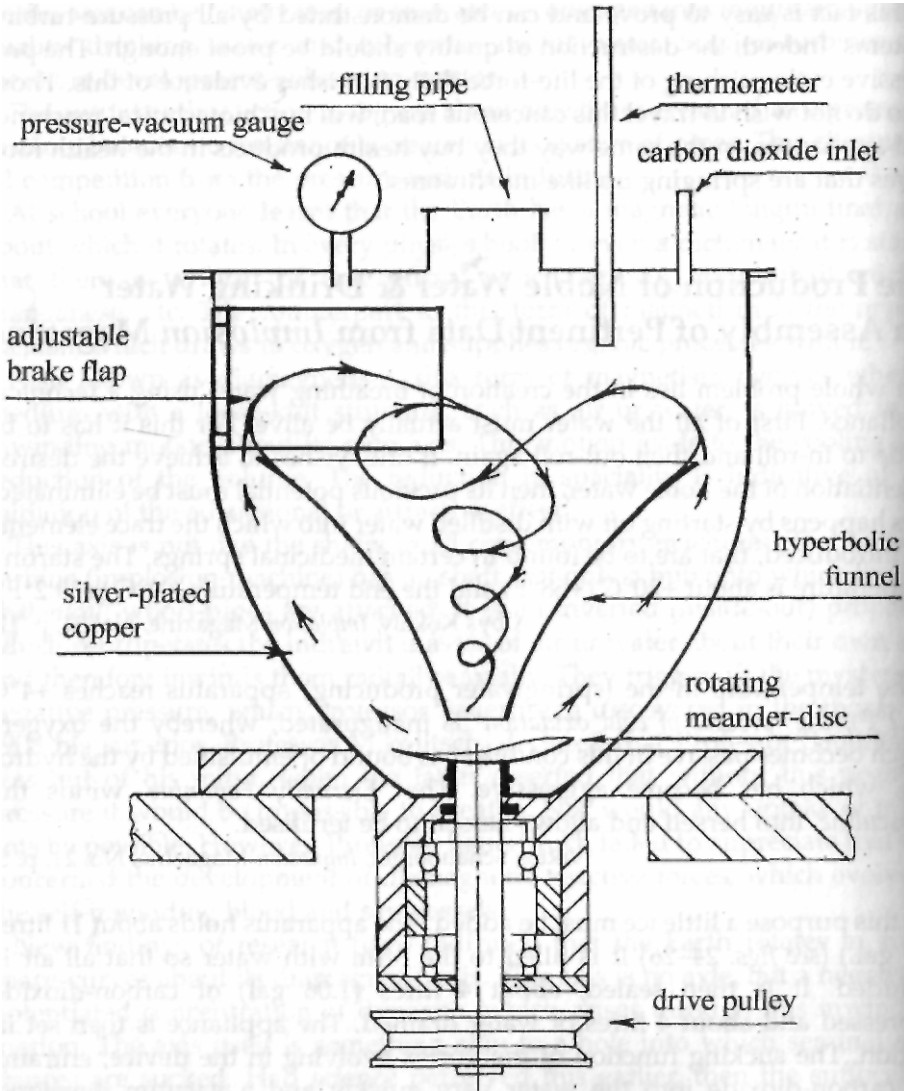

Design Principle for the Repulsator

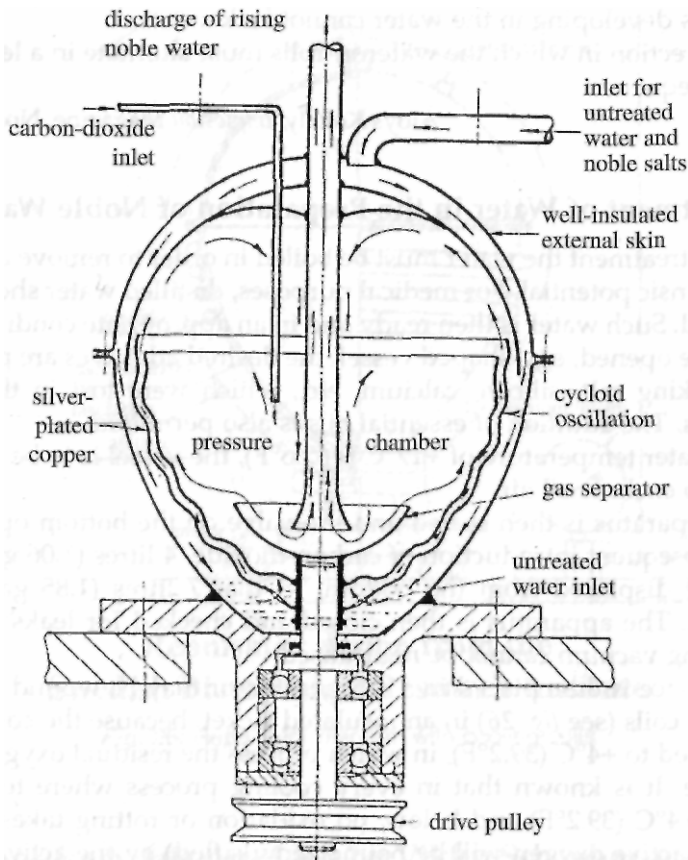

Fig. 25: Repulsator cross-sectional drawing

A Water-Ennobling Device must satisfy the Following Criteria:

- (a) The water must be able to in-roll on itself, as happens in a natural water-fall.
- (b) The water must be able to breathe in order to be to take up added ingredients. These substances can be of solid, liquid or gaseous nature.
- (c) A temperature-gradient must evolve; the water must be cooled from  $+17^{\circ}\text{C}$  ( $+62.6^{\circ}\text{F}$ ) down to  $+4^{\circ}\text{C}$  ( $39.2^{\circ}\text{F}$ ), its condition of greatest specific density.
- (d) It must be possible to accelerate the movement of the water.
- (e) The vacuum that soon appears due to the densation of the water and the uptake of carbon-dioxide, must be sealed and protected against external influences.

- (f) The device must be so insulated externally that the electromagnetic charges developing in the water cannot leak away.
- (g) The direction in which the water in-rolls must alternate in a left and right hand sequence.

Aloys Kokaly, Implosion Magazine, No. 54/55, p.45.

### The Treatment of Water in the Preparation of Noble Water

1. Before treatment the water must be boiled in order to remove any dirt and its intrinsic potential. For medical purposes, distilled water should always be used. Such water is then ready and in an appropriate condition for use.
2. Into the opened, egg-shaped vessel, the desired additives are placed, such as cooking salt, silicon, calcium, etc., which were lost in the previous process. The addition of essential oils is also permitted.
3. At a water temperature of  $+17^{\circ}\text{C}$  ( $+62.6^{\circ}\text{F}$ ), the vessel is to be filled to the brim to exclude all air.
4. The apparatus is then sealed and the valve on the bottom opened. With the subsequent introduction of carbon-dioxide, 4 litres (1.06 gal) of water will be displaced from the bottom, so that 7 litres (1.85 gal) of water remain. The apparatus is then closed and checked for leaks, so that the evolving vacuum cannot be neutralised.
5. The device is then placed in a refrigerator, or may be wound with refrigerating coils (see fig. 26) in an insulated jacket, because the contents must be cooled to  $+4^{\circ}\text{C}$  ( $39.2^{\circ}\text{F}$ ), in which process the residual oxygen becomes passive. It is known that in every cooling process where temperatures reach  $+4^{\circ}\text{C}$  ( $39.2^{\circ}\text{F}$ ) and below, no oxidation or rotting takes place. The now inactive oxygen will be bound (emulsified) by the activated hydrogen and carbon-dioxide.
6. Meanwhile the motor is switched on and the contents of water will be propelled upwards along a centrifugating spiral column. In a certain sense, this represents the breathing of the water. The water is moved by a motor-driven rotating concave copper disc.
7. In the upper half of the apparatus a rotating copper dome-shaped enclosure is incorporated. The rotating water will be pressed inwards by this and flows downwards in the form of an in-rolling spiral. The point of this vortex, similar to a tornado, lands on the lower rotating copper disc and the whole process begins anew.
8. The automatic control of the motor's alternating direction of rotation to right and left is intended to copy the right-hand $\leftrightarrow$ left-hand curvilinear flow of water in natural, untouched watercourses, where the water will always swing from one side to the other.

Aloys Kokaly, Implosion Magazine, No. 85, pp 9-10.

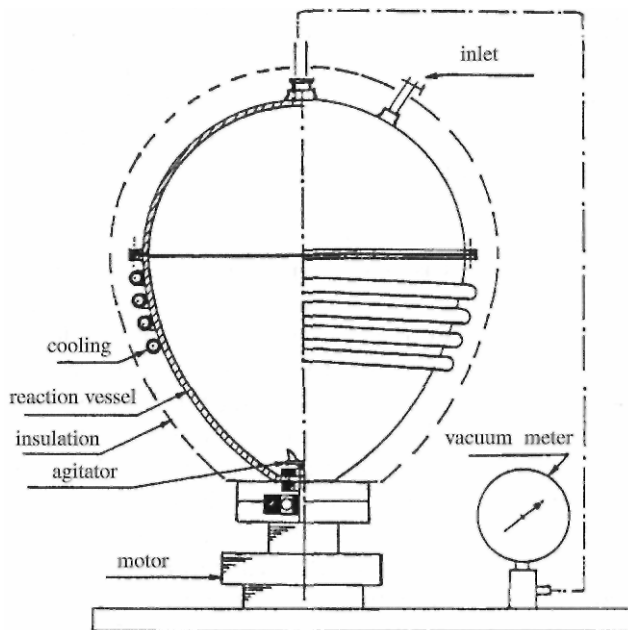

Repulsator design from the  
Swedish Biotechnical Research Institute

Fig. 26: Repulsator diagram with cooling coils

Instructions from data provided by Viktor Schauberger

Viktor Schauberger, Implosion Magazine, No. 36, pp 30-32.

1. An egg should be filled to the brim with springwater (under no circumstances should it contain any chlorine) or aqua destillata or carbonated water (soda siphon water). Starting temperature should not exceed  $+27^{\circ}\text{C}$  ( $+80.6^{\circ}\text{F}$ ). First attempts should be made using well-boiled well-water, which should be allowed to cool to  $+17^{\circ}\text{C}$  ( $+62.6^{\circ}\text{F}$ ) before being poured into the egg. In this regard the water must be poured in very carefully to avoid entry of any sediment. All foam and surface scum to be skimmed off.
2. Two opaque, dark bottles (beer bottles, for example) should be half-filled with the above water, one of which should receive the prescribed quantity of calcium and the other, the three other ingredients or sediments<sup>2</sup>. It is

<sup>2</sup> These are not specified, but may relate to the ingredients necessary for remedying specific deficiencies in the water being ennobled at the time. — Ed.

- very important that one bottle should be filled with calcium only. The two bottles are then shaken thoroughly for a few minutes until the water in both has become milky. The bottle containing the three sediments should be poured into the egg first, followed by the bottle containing calcium. The latter should be handled with care and should be stored in the dark. At first the water appears milky, but clears itself during the inwinding process.
3. Sufficient carbon-dioxide should then be introduced in order to expel the last traces of air. This is best done with a vacuum pump, whereby any desired quantity of carbon-dioxide can be admixed, or whose addition can thereby be regulated. Regulation is also possible with the reduction valve. The right quantity of carbon-dioxide can only be determined by experiment, which is possible by tasting the finished water. If the carbon-dioxide is noticeable, then too much has been added. If the water is too hard, then the amount of calcium is excessive. Whatever ingredient or sediment comes to the fore must be reduced in quantity. If the water is insufficiently refreshing, then the magnesium should be increased. The mixture is correct if no sediment or carbon-dioxide is particularly noticeable in the water. If the water is insufficiently invigorating, then there is not enough carbon-dioxide.
  4. After the cover of the egg has been sealed, then it should be allowed to operate for about 3/4 of an hour. The best time to do this is before 9.00 am. During thunderstorms or immediately prior to them, attempts to produce good water are unsuccessful. All smelly, aromatic or odorous material should be removed from the vicinity of the egg, because the fermenting water attracts and absorbs all aromas, particularly those of onions, garlic, soap, etc. The vacuum must be allowed to develop slowly (about 300 rpm should suffice). Rapid vacuum development is unproductive and should be avoided. It is enough if 0.8 - 0.96 absolute atmospheres have been achieved by the end of the process.
  5. The external temperature during the regenerative process should be at least +3°C (+37.4°F), since it effects the internal temperature. After completion of the fermentation, then the external temperature should be maintained at +4°C (39.2°F). Maturation takes about 24 hours and should take place in the egg itself or in clean glass vessels stored away from all light and heat.
  6. When analysed, the finished water should be deficient in oxygen. The water actually still contains oxygen, although it is bound by the carbon-dioxide. The water's potency is increased in this way, which is not the case in soda siphons.
  7. The water should only be drunk in small quantities at temperatures not exceeding +7°C (+44.6°F), for the water already begins to deteriorate at

+9°C (+48.2°F) and therefore it should always be transported in thermos-flasks to prevent the temperature rising above +7°C (+44.6°F). Drinking this water provokes strong elimination or excretion, because all waste-matter is expelled from the body. The appetite is strongly stimulated. Diamagnetism disappears after 24 hours, which impairs the healing effects.

### Ingredients Required for about 10 litres of Water

Potassium (K)	= 0.0034 mg/kg	Chlorine (Cl)	= 0.0257 mg/kg
Sodium (Na)	= 0.0776 mg/kg	Sulphate	= 0.1301 mg/kg
Calcium (Ca)	= 0.0215 mg/kg	Bicarbonate	= 0.0638 mg/kg
Magnesium (Mg)	= 0.00039 mg/k	Nitrite	= 0.0001 mg/kg
Iron (Fe)	= 0.00042 mg/kg	Fluorine (F)	= 0.0028 mg/kg
Manganese (Mn)	= 0.0001 mg/kg	Thiosulphate	= 0.00055 mg/kg
Lithium (Li)	= 0.00022 mg/kg	Malic acid	= 0.0754 mg/kg
Strontium (Sr)	= 0.00047 mg/kg	Metaboric acid	= 0.00497 mg/kg
Aluminium (Al)	= 0.0002 mg/kg	Free CO <sub>2</sub>	= 0.0054 mg/kg



10.

## The Klimator

"I can generate suctional forces, which act indirectly and are entirely undetectable. No current of air can be noticed; only an almost imperceptible cooling, as occurs when air is sucked in strongly with the back of the hand held in front of the mouth. It is therefore incorrect to say that I have copied the cyclones and typhoons of the tropics."

Viktor Schauburger, Implosion Magazine, No. 83, p. 17.

## Cold and Hot Machines - Cooling-Heating Machines

From Spec. Ed. Mensch und Technik, Vol. 2,1993, section 7.5.

I have certain devices in my possession that can cool a river with a temperature of about  $+20^{\circ}\text{C}$  ( $+68^{\circ}\text{F}$ ) down to below  $0^{\circ}\text{C}$  ( $+32^{\circ}\text{F}$ ) in a few minutes without any cooling equipment of current design (ice or refrigerator). The breath-like regulation of oxygen between interconnected vessels (containing copper and zinc plates) is enough to eliminate thousands of heat-calories in a few seconds, or convert them into cold substances. These simple, natural processes are valid for temperature fluctuations in excess of  $60^{\circ}\text{C}$  ( $108^{\circ}\text{F}$ ). This involves the atomic dissociation of air or aqueous substances.

I am now having machines built, which generate heat or cold organically. (see fig. 27) Heat or cold-producing dynamos of 1/8th horsepower heat and cool in a cold combustion process, without fire. The device is both heater and refrigerator. By means of an organic vacuum, it lifts water or air to any height, converts water or air into an immaterial form and distils the starting product, so that any kind of water or air can be produced. Main criterion: The correct composition of the material. Study catalysts that separate oxygen from water. For experiments use caustic potash and zinc, or sodium. To dissipate the additional heat, bind aluminium and silica with waterglass. The ratio of 1:1 is not right, because the resultant temperature is too high. Intuitively it should be in

the ratio of 2:3, wherein the C-substances must predominate. The number of revolutions per minute should be between 4,000 and 9,000. Basic concept is planetary motion with suction and pressure on opposite sides of the catalyst. Depending on the rate of rotation, there can be a 350,000-fold increase in weight or pressure. The device can also be used to produce the cheapest artificial petrol.

With one system as big as a fist, houses can be heated. On the other hand, any desired low temperature can be achieved merely by adjusting the needle-jets. Small motive impulses only are required to set it in motion - kick-starter or electrical starter-motor.

In a vacuum water will be evaporated and by means of cold is transformed (through mutators) into a gaseous state. In my next device air will be converted into electrozoic energy.<sup>1</sup> This is how the organic or physical vacuum comes into being, which even in small machines consumes about 4m<sup>3</sup> (141.24 ft<sup>3</sup>) of air per second, delivering about 10,000 hp to the drive-shaft to do work. If a physical vacuum is created in front of the suction-intake openings, then the machine itself is drawn forwards by this force, thus opening the way to the production of silent, fuel-less aircraft (in the current meaning of the word).

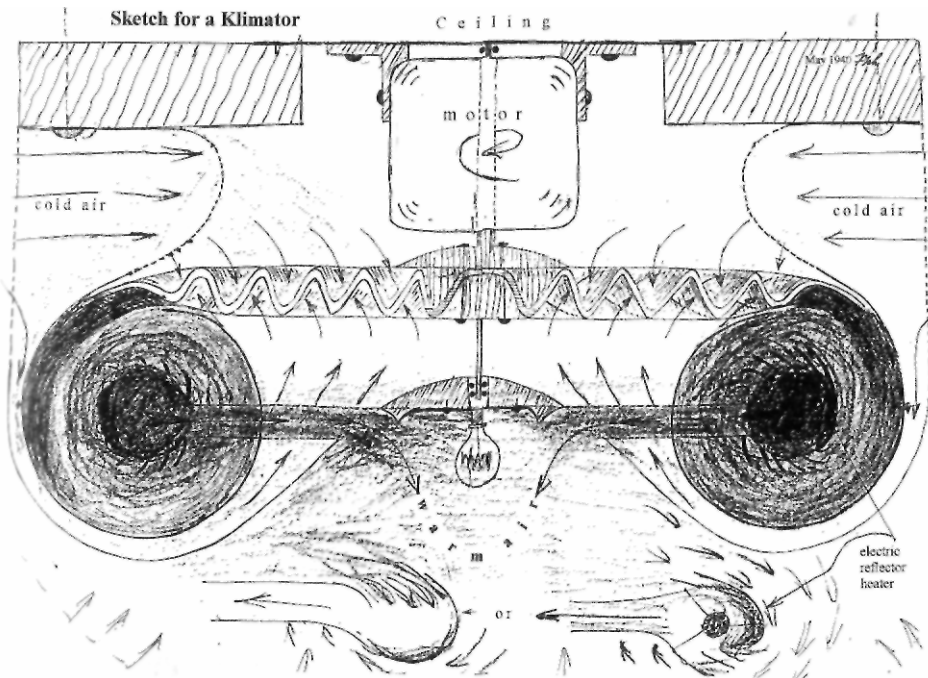

Fig. 27: The Klimator

<sup>1</sup> Electrozoic energy: an animalistic or organismic form of electrical energy. — Ed.

## The Klimator - a New Form of Synthesising Current produced by a Space-Energy Generator

From Implosion Magazine, No. 77, written in Leonstein 25:8:1945.

### Central heating with reactive forms of heat

In exactly the same way as happened after World War I, there is no other solution to the present shortage of coal than to cut down the forest in order to heal our houses over the coming winter. As a result:

1. A valuable national asset will be further destroyed.
2. A whole string of new economic disasters will ensue.
3. Nothing will be achieved of any practical value.

Assuming that we are able to fell such a large number of trees, then, as also happened after World War I, it will be impossible to transport the green and heavy fire-wood logs to the railways and on to further destinations, due to the lack of draft-animals and fuel. What is actually delivered, can barely be burned for at least six months, because firewood must first be dried out. At the same time the generation of an unhealthy form of heat, conducive to the propagation of bacteria will result.

People should send me a few sheets of copper (Cu), brass ( $\text{Cu}_5\text{Zn}_8$ ,  $\text{Cu}_9\text{Al}_4$ ,  $\text{Cu}_3\text{Sn}_8$ ) or aluminium (Al), which should be 0.8-1.0 mm (0.0315-0.0394 in.) thick. Steel sheet is hard to bend, although it is also very suitable. It is not worth having a press-die specially made merely to build a prototype to demonstrate how this problem can be solved naturally and inexpensively. Hardly anyone will be able to understand the essential nature of this new system of heating. Nevertheless, the attempt should be made in order to create interest.

It is a well-known fact that it is warm below the ground-surface in winter and cool in summer. These variations in temperature originate from material changes in the raw materials present in the ground and in part are also effected through the 'cycloid-spiral-space-curve motion' of the Earth. These internal and external changes in motion are brought about as Nature increases the intensity of the Sun's rays in summer by lengthening their developmental path<sup>2</sup> and weakens them in winter through the earthward approach of the Sun at perihelion. In very general terms this enables dense agglomerations of

<sup>2</sup> In the northern hemisphere summer the distance between Sun and Earth increases to a maximum at aphelion about the 1st of June. — Ed.

oxygen to enter the ground. It is the same process that happens in a motor in cool weather or at night. The oxygen then consumes the residual matter, which the Earth created during the summer out of the earthly remains of deceased life-forms with the aid of her cycloid-spiral-space-curve motion.

The movement of sap in summer and its state of rest in winter are the biological sequel to the above variations in intensity. These are the cause of the different motions, which in turn contribute towards the intensification of the Earth's new processes. It is only in this way that qualigen is to be understood, whose waste-matter is also involved in the generation of reactive, falling and therefore concentrating influences of heat. Without these influences no growth is possible. It is these falling and concentrating forms of heat that are of interest to us at the moment, since they can solve the most urgent problems of fuel and heating quickly and simply. They are about 90% more efficient than normal methods of heating for the simple reason that they are produced from the waste-products of qualigen and hence will function equally efficiently in large, medium or very small heating appliances.

A great deal of time, effort and expense can thus be spared using this naturalesque method of heating. Wood and coal will become as good as obsolete. In Nature nothing happens directly, but only indirectly. Without waste-matter, therefore, no growth and no gain is possible. As far as present heating problems are concerned, the trick is to learn how to make use of those waste-products that generate falling and concentrating heat rays. These heat from above downwards in the same way that the Sun heats the surface of the Earth.

For this purpose a Klimator is required. What is a Klimator? It is merely a type of dynamo that generates natural forms of temperature, or more accurately, falling and concentrating heat rays as well as naturally rising and expanding forms of cold. The latter are health-promoting and lethal to bacteria.

The Klimator essentially consists of three special components (see fig. 28) and:

1. Is a small, conventional heating element, which is incorporated in the middle of a sort of selenium cell<sup>3</sup>, which is surrounded by a material mass. As in a natural living cell (similar to a protoplasm), all major and secondary basic elements are present in an allotropic state. Herein are contained all stocks of allotropic fructigens and seminal substances, oligodynamic (decay-promoting) and catalytic (growth-accelerating), exciting substances.
2. Is a diminutive, but faithful copy of the Earth itself, within which an agitator rotates, which is attached to the end of the vertical shaft. In addition,

<sup>3</sup> Selenium's electrical resistance increases with exposure to light and a selenium cell is a type of photoelectric cell comprising a thin coating of selenium applied to a metal disc and covered with a layer of gold or platinum thin enough to allow the passage of light. — Ed.

the Klimator consists of a series of nested, rilled, calyx-like<sup>4</sup> vanes, which are so constructed that the through-flowing masses, such as water and air, can be bio-centrifugated. Through the increase in centripetating and centrifugating velocities, which have hitherto never been achieved anywhere, increases in pressure and suction are produced, which reciprocally amplify each other exponentially. This results in the decomposition of the water and air due to the thorough trituration of the smallest molecules of sediment, leading to the development of a hitherto unknown process of synthesis. This gives rise to two longitudinally oriented types of inward flowing, spiral-like currents, one flowing upwards and the other downwards.

3. A small generator is also incorporated in the Klimator, whose armature is fixed and about which the stator rotates.

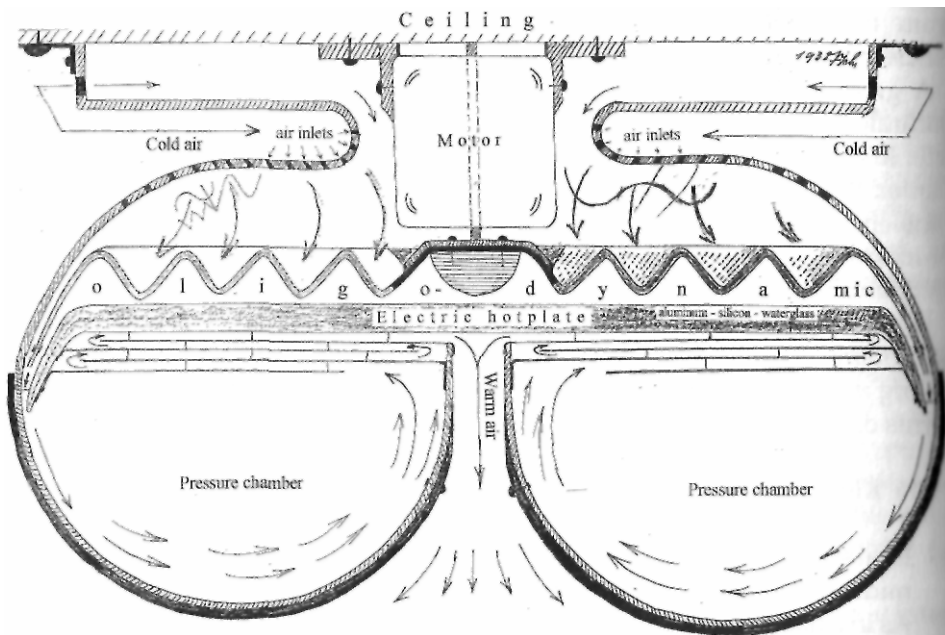

Fig. 28: The Klimator

The primary product of synthesis, a biomagnetic formative and levitative current, will not be elaborated in more detail here, since we are primarily interested in the solution of the problem of heating, namely, with the function

<sup>4</sup> Calyx = the sepals of a flower collectively forming the outer floral envelope, protective of the bud. - Ed.

of the secondary or reflux current. This is a potential with which it is possible to heat up a space from the ceiling downwards, like the Sun does. It is a radiant form of heat, which heats the whole space evenly. If the intensity of the small heating resistance (element) is reduced, however, for which the rate of rotation of the agitator must be increased, then the living space is suffused with an evenly dispersed, rising, expanding and high-altitude-like fresh air. In this way the natural, reactive forms of temperature are produced nearly free of cost, through which the natural warmth of the valley-climate comes into being. It is a mountain micro-climate.

The Klimator represents the most basic developmental form in which the natural, primary motive forces can evolve, whose two components are to be differentiated as:

- (a) The metaphysical, which acts from the inside outwards, and
- (b) The physical, which acts from the outside inwards.

Both these higher forms of pressure and suction together produce the 'original' form of motion through which the higher influence arises, which in turn generates the increased and qualitatively improved, primary life-energy. This original way of generating natural formative and levitative essences is exploited by the stationary trout, which stands motionless in fast-flowing torrents and darts upstream like lightning when danger threatens, wherein it cannot only overcome its own body-weight, but also, swimming freely and without other assistance, overcomes the weight of the oncoming water. This was previously inexplicable as far as science was concerned.

The secret of this mysterious overcoming of gravity solves the problem of the aforementioned, hitherto unknown synthesising current, which is triggered off through the cold metabolic process. Contemporary science knows nothing about it, because it only uses warm processes of oxidation, which triggers the counter-current to the above current. This, however, is the most dangerous current of all.

This annihilating current science uses for mechanical power and to heat living spaces. The suppression of the life-current means the gradual elimination of the life-force leading to disease and premature death.

Progress can only be made in the search for the synthesising current and quality of life when all substances are moved inwindingly. The cyloidally moving Earth demonstrates this to us daily. It was a trout that showed it to me. With the Klimator, the Repulsator and the Repulsine the first atom-bomb that rises can be produced instead of one that falls. The latter achieved the veritable zenith of almost complete annihilation with the aid of the most efficacious combustion process of all. But with it came the long-sought turning point, for in all truth no deeper nadir could have been reached.

## Technology & Bio-Technology

The naturalesque Mr-generation of power, heat and light

Biotechnisches Versuchsinstitut (i.Gr.), Oct. 1946 - from Implosion Magazine, No. 116, pp 37-45.

The no longer mysterious secret of the naturalesque generation of power, heat, cold and light lies hidden in the substance that today's technologists combust, from which the so-called 'calories' arise, and which understandably disappear when we drive our machines with Nature's principal formative substance (fatty-matter), or use it for heating or for generating low-grade light.

Derived from the ancient Greek word 'technao', technology means 'self-cheating' or 'self-deception'. Actually it ought to be called 'stupidity', because all we have to do is merely to move what actually 'moves, heats and illuminates' naturalesquely in order to be able to set every kind of machine in motion 'originally' or to produce heat and light naturalesquely.

For this reason the ancient Greeks also rejected 'technology' in any form. Instead they captured slaves so as to have the more demeaning and demanding tasks carried out by these natural machines, which run on metaphysical fatty-matter.

In order to eat today the wretched slaves scramble for work, burrowing into the earth for coal, felling the forests and extracting oil from the ground, in order, so they believe, to alleviate their lot, but achieve precisely the opposite. More and more people have to work and the more diligently they slave away, the more keenly the hunger they will have to experience, because without coal, timber and oil no growth of vegetation is possible. In other words, there will be an increasing dearth of all that is most vital to life, if by the sweat of our brows we inhibit the build-up of quality matter and exploit Nature's most important formative substance - fatty-matter - for every possible and impossible purpose, i.e. to drive machines and for ridiculous methods of lighting and heating: All this in the belief that these earthly residues of fatty-matter would in any case be reduced to dust and ashes if left in the ground, and therefore it does not matter whether we make soap or something else out of them, or merely combust them.

Today this is totally unnecessary. Naturally there will be a hue and cry from all the well-camouflaged slave-masters, who earn fat sums through those they lead around by the nose, once the bio-technical secret is revealed and the mentally castrated work-oxen are shown the way to move this mysterious fatty-matter naturalesquely. This will provoke an upheaval of a kind that humanity has never yet experienced, because mechanical power, heat and light will be as good as free. In the future no intelligent person will operate

machines or even generate heat and light with Nature's principal working material, but will make the actual 'mover and Life re-awakener' move bio-technically.

To learn this art it is necessary above all to explain two fundamental concepts. Firstly, what actually is 'substance' and secondly what actually is 'motion' ? From a naturalesque viewpoint, the term 'substance' is to be envisaged as a more or less highly developed energy-concentrate; a lattice of atoms, as it were, or as the word 'lattice' implies, a sort of prison, in which Nature's principal formative substance - the fatty-matter in the process of change and formation - also resides in an allotropic (naturally congealed or condensed) state. This only awaits the naturalesque motive impulse in order to be elevated to a 'freely moving' atomic state, which happens all the more rapidly, the faster this energy-concentrate in a latent transitional state is rotated in inwinding space-spiral-curves about its own axis by means of so-called venal-motion. Immediately thereafter, what has come into being in this way is moved further in so-called arterial-motion in order to distribute what has been 'freely formed' by way of naturalesque rhythmical motion through the surrounding body (the soil) in order to bring it to life.

With this the secret of biotechnical motion stands revealed and all that remains is to explain the mysterious machine with which it is possible to ur-generate the 'originally moving and resuscitating', i.e. a higher-grade potential. With its use all machines can be powered and our homes heated and illuminated independently. Moreover, all growth - which is none other than the natural solidification of energy-concentrates - can be stimulated and increased as well as qualitatively improved. In short, our every wish can be fulfilled with very little effort.

Naturally all this will be described as Utopian, as the product of a deranged mind intent on creating all kinds of confusion amidst the present economic chaos caused by the insanity of combusting Nature's most vital primary substances. Consequently, great concern for the continuing supply of fatty-matter will inevitably arise; a substance that nowadays not only every housewife lacks<sup>5</sup>, but one that is also lacking in the form of what might be called 'cerebral lubricant'. For it is from the brain that all healthy thoughts arise, and above all the idea of doing things in accordance with Nature in the future; something the director of an institute for commodity studies naturally cannot immediately appreciate. Therefore a number of other things must be explained in greater detail in order to make it clear to the various ministers of government departments as well. This is necessary so as to enable an increased production of commodities and above all a faster growth of calories, which under the present circumstances are not only being increasingly wasted, but ultimately would go to waste entirely were such individuals not

<sup>5</sup> This relates to the severe food shortages and rationing in Austria in the immediate post-war period.  
- Ed.



to be enlightened by an outsider. That is, were the fundamental concepts of 'biotechnology' not explained in a generally understandable way.

Under the concept 'motion' we have to visualise a rhythmical combination of pressure and suction, wherein it is of crucial importance whether pressure or suction predominates. If the former prevails, then a decadent potential or expressed more scientifically, an oxidation, takes place, which should generally be understood as a highly combustive process that inhibits development.

In contrast, if suction prevails during a naturalesque course of motion, then a reduction process occurs, which is here to be generally understood as the aforesaid higher-grade transformation of an already high-grade material into spirit, or expressed more scientifically, into the above form of higher-grade potential. Naturally, this is also the source of higher-grade temperature and light phenomena, which as development-furthering instrumentalities, foster the development of naturalesque motive forces, high-grade heat and cold as well as light.

In this formative process *il primo muovere*, the initial motive impulse, also plays a decisive role. If any motion is actuated by a pressure-induced axial->radial (see fig. 14) impulse and pressure prevails, then the decadent form of potential results, because in this case the atom lattice ruptures due to the release of its content of unipolar and highly aggressive allotropic oxygen. In other words, when the oxygen has attained the energetic state that enables it to encircle the fatty-matter (carbone). The latter having become passive and coincident (internally collapsed) under this lower-grade heat influence, the oxygen loops around it in spiral-space-curves, and engulfs, consumes and digests it.

The offspring of this outbirth of decadent energies are lower-grade temperatures, i.e. rising heat-forms and falling cold-forms, which foster the decay process. Subsequently, with the aid of these solidifying cold-forms, the relapse into the earth of what has missed its way on evolution's upward path ensues.

However, if a motion is initiated by a radial->axial impulse, i.e. if the initiating upward suction and inward impulsion are triggered simultaneously, then firstly the atom lattice of basic elements is disassembled naturalesquely, because under this centripetal motion it is only the oxygen that reacts and contracts into itself. Secondly, due to the developing coolness that occurs with all sucking action, the fatty-matter (carboni), which become free, unipolar and highly active then encircles the oxygen, also loops around it in inwinding spiral curves, and engulfs and digests it. The product of this metabolic process is the higher-grade potential, which immediately gives rise to higher-grade temperature-forms, i.e. falling and concentrating heat-forms and rising and expanding invigorative cold-forms. These combine the highest-grade elements into a new atom lattice and propel the product of this high-grade synthesis, which already has a desire to rise, into even higher zones of evolution.

To restate the process briefly: axial->radial ex-pulsion results in ex-plosion, decay and combustion. Ira-pulsion, or a radial->axial impetus results in im-plosion, ennoblement and autonomous upward displacement (levitation). In this case reactive suctional forces operate first during the ascent and are then reinforced by supplementary reactive forces. This is how physical weight is overcome naturalesquely, during which process the already higher-grade energetic ballasting elements are precipitated out and manifest themselves as falling and concentrating heat-forms.

If this formative process is copied naturalesquely in a so-called Klimator (see figs. 27 and 28), which is suspended from the ceiling and moved bio-centrifugally then a falling and concentrating heat-form is produced with which the living space can be naturalesquely heated in winter.

If these invigorative cold-forms with their rising and expanding properties are introduced into an evacuated glass bulb, then the energy-concentrates, which in any case move exceptionally rapidly, exceed their highest velocity in this resistance-less space. In the process they eject high-grade ballast material which interacts with the residual oxygen still present in an extremely rarefied state. The product of this renewed union is atmospheric space-light, naturalesquely copied sunlight as it were. This evolves and lights up the vacuum bulb when the bulb, which has no other connections apart from the earth-wire, is merely earthed. All that is required therefore is to connect the earth-wire in order to make the living space as bright as day. To extinguish this natural light, which is of course temperatureless, the earth-wire is simply disconnected.

If virtually free mechanical power is required, then the above higher-grade heating effects merely need to be switched off, thus converting them into formative and levitative invigorative forms (cold-forms). This immediately reactivates the 'ur-powerfully-waxing' buoyant motion, which here should be envisaged as a bio-magnetic up-current (a synthesising current). With elemental force arising from an energy gradient that evolves along a common developmental axis, this up-current sucks up the generating device in its wake, i.e. it effortlessly overcomes its own weight. Aircraft, submarines or heavy projectiles can be propelled like lightning in this way at negligible cost. In stationary machines on the other hand, which must be well anchored to the ground, the indrawn air will be almost instantaneously decomposed, transformed and built up as described earlier by passing through a curviform pipe. The concurrently coincident water, i.e. the discharged and inwardly collapsed medium, will be expelled at the same time, resulting in the ur-generation of a high-grade high-quality space - the 'organic' vacuum. This is the opposite of atmospheric air pressure and is the best and cheapest attractional force to be found anywhere on this planet. It is also the 'space' that produces ray-like forms which penetrate through all enclosures and stream upwards.

If a communicating pipe is interposed between this naturalesquely evacuated highly potent vacuity imbued with qualigens and the outer pressure of atmospheric space, and if a propeller or turbine is installed inside it, then the external atmospheric pressure exerts a force of  $1 \text{ atm/cm}^2$  on the inclined blades of the propeller (turbine).

Since any desired volume of air can be reduced (transformed into formations of qualigen) in a fraction of a second with a naturalesquely constructed Repulsine (see figs. 30-33), for which at most a driving force of 0.8 kW is required, the levitative torque-producing force generated, or more correctly ur-generated, in this way is as good as free. For here, with increasing velocity due to the upward activation of the above bio-synthesising torque-producing force, the Repulsine's power increases by the square of the ur-generative motion. This is to be compared with the increase in the resistance to motion in all 'technical' machines, where understandably, due to the reversed direction of motion the forces of recoil increase in the same ratio as described above.

That is to say, today's technology strives to move forwards with forces that operate backwards. Logically what has been achieved is not only a reversal of motion, but also of the economy; an economic decline resulting from the mechanical build-up of decadent repulsive pressures, which naturally have a decadent or destructive effect economically. Consequently, the economy will become increasingly unhealthy, the more widespread and intensive such technology, this self-deception becomes, or to put it mildly, the more the abysmal stupidity of generating decadent energies mechanically takes effect.

This tragic aberration was inaugurated by the foolish belief that the progress of evolution comes to a halt when the life-functions are apparently extinguished and that the so-called soul escapes after the cessation of vital activity. In reality the true resurrection only begins after the proper decomposition of an atom lattice (fatty-matter concentrate) that has fallen back into the earth with the aid of and because of the cycloid-space-curve motion of the Earth itself, which provides the radial->axial im-pulse. In contrast, all 'technical' machines, i.e. all dynamos, turbines, pressure pumps, propellers, explosion and steam driven engines, all furnaces, gas and electric heating appliances, all soil-tilling and harvesting machinery, etc. provide a developmentally harmful ex-pulse to initiate motion. Because of this and without exception, the atom lattice thus moved ruptures, resulting in the disintegration of the molecular (bacteriophagous) formations in suspension. In unnaturally moved air or water decadent stresses appear, causing the decay of the devise energy-concentrates (as a graphic example, see hydraulic river regulation and torrent confinement<sup>6</sup>). This leads to the build-up of decadent potential and the decomposition of the blood of the Earth, and thus to a total economic collapse along the whole course of development.

<sup>6</sup> See sections on river engineering in *The Water Wizard*, Vol. I of the Ecotechnology series. — Ed.

The possibility of ur-generating virtually free mechanical power, heat, cold and temperature-less light, however, is only the first step towards cultural (economic) reconstruction. For with venal-motion, it goes without saying that the highest quality blood of the Earth - water containing exceptionally potent substances - can be produced by mechanical means. With this water not only can reactive expansive pressures be generated and all petroleum fuels, etc. replaced, but all cancerous decay can also be healed naturally, which would revolutionise medicine, i.e. put it back on the right track.

In a word, the naturalesque movement of any given medium and the atom lattice it contains, signifies a social reconstruction in every sense, because all slave-labour will cease with the restoration of natural abundance and freedom of movement. Everyone will be free and independent, and healthy once more in mind and body. This will happen for the sole reason that any given atom lattice - like the body of a dead animal or plant - can be transformed and built up with the aid of venal-motion, whereupon the subtle physical energies - the so-called life-forces - then come into being, which through this revitalising process move our bodies originally (autonomously).

Precisely the same thing happens at a large scale if we transform and build up bacteriophagous threshold structures (minute molecular atom lattices of water or air) mechanically through venal-motion, and thereafter distribute these specifically densified higher-grade energy-concentrates where required by way of arterial-motion. This will reimburse the surrounding body or geosphere - the macro atom lattice - with life and restore its inner vibration. We have only to intensify this formative oscillating motion in order to stimulate the macro-climate or higher-grade potential out of which displacement, namely physical movement, reproduction and further development, arises as the biological sequel to a naturalesque motive impulse.

With this I place the lever or the fulcrum that lies beyond space and time in the hands of humanity, which will enable the normalisation of those evolutive processes whose normal motion has been dislocated and in this way the standard of living can be simply and fundamentally improved along the whole chain of development. Only when this is done can reconstruction

finally begin in a truly natural way.

In this regard all institutes for commodity studies and research are outdated and for this reason the Visamontana Biotechnical Research Institute Ltd<sup>7</sup> has been registered with the chamber of commerce.

It is in the close interest of those who play a leading role in government to enable this research institute to come into operation quickly, because all the preconditions now exist for implementing these formative atomic energies

<sup>7</sup> The name 'Schauberger' can be broken down into two concepts — "Schau" = look/see and "berger" = of the mountain. Hence the Latin-derived name Visa (look/see) + montana (mountain) = Visamontana. — Ed.

practically. This will put an end to the present world-wide shortages of raw materials, food, fuel and germinating substances, which had to happen because the workings of evolution were subverted and put into reverse gear through the reversal of the naturalesque motive impulse.

There can be no doubting what has been stated, because it is founded on indisputable practical results. It is contemporary science that erred and which, on the basis of various inventions, took the wrong evolutionary road. Science must now be shown another way by an outsider, and if not of its own free will, will be forced to do so by the mass of the people deprived of their most primitive rights to life.

To err is human. It would be inhuman, however, now to delay and arrest this fresh start for the sake of scientific prestige or other interests. For in the present situation the life of millions upon millions of people, already hungry and freezing, is at stake.

For this reason all this will be presented to the competent authorities and once more emphasised that the economy cannot move forward in reverse gear. Therefore everything must be switched around all along the line.

# 11.

## Machines of the Genus — Repulsine

### The Repulsine

From Implosion Magazine, No. 36, written in Vienna, 1944.

**W**hat is it? What is it for? What does science say about it? These three questions are asked repeatedly. They will therefore be answered first in general terms and then in more detail. The Repulsine is a germinal-matter generator with which humanity can once more be returned to Paradise and whence all wearers of mitre-boards, gowns, cassocks and cowls will have been expelled by fire and sword. Science and its berobed representatives would no longer be asked for their opinion and they will all be indicted regardless of whether they are knowingly or unknowingly guilty - questions they will have to decide for themselves. They will be accused of being accessories to the crime against the germinating force. Generally speaking, this relates to the suppression of the production of qualigen for the purpose of creating an artificial shortage of food; for fostering an increasing feeble-mindedness; for promoting a constant and thriving trade in foodstuffs; for ensuring that the sheep on this increasingly barren heath are not well paid by promulgating a belief that does not accord with the truth. The suppression of qualigen was therefore the precondition for the filthiest traffic there ever was, is or will be. In order to power its machines, today's science gives priority to an oxidising or metabolic process, wherein oxygen (atmospheric oxygen) - the natural stuff of breath - consumes the lower oxide or protoxide<sup>1</sup> (a type of metallic calc or calx<sup>2</sup>)

<sup>1</sup> Protoxide: The oxide of an element that contains the smallest amount of oxygen of any of its oxides. Collins English Dictionary. — Ed.

<sup>2</sup> Calx = calcined metal, the powdery oxide formed when an ore or mineral is roasted, or another name for calcium oxide. Calcined = to heat a substance so that it is oxidised, reduced or loses water.; to oxidise as a result of heating Metallic = of a metal element existing in the free state, rather than in combination. Collins English Dictionary. - Ed.

which contains valuable growth-factors and which is a geospheric formative substance.

This interchange of substance (metabolism,) is referred to as the 'normal' combustion process and people are of the mistaken opinion, that it gives rise to those carrying, shifting and orienting forces that move and animate our bodies. This 'normal' process of combustion, whose dynamic product Nature uses to break down, decompose and eliminate the evolutionally unfit, is triggered in such a way that at about +40°C (+104°F), through the application of heat or fire, the oxygen becomes aggressive and belligerent. If it is heated further, then it becomes even freer and more dangerous, leading to the decomposition of blood, water and sap. At this point all life-functions of whatever kind cease in all growing, living and autonomously moving things.

The reason for this is the growing inactivity of the protoxide, which becomes less and less active as the above-normal temperature rises. The end-product of this immobilising process is annihilating fire. The dynamic product of this metabolic process is an increase in the 'normal' rising, expanding, and braking form of heat. This heat-form is alone responsible for the decomposition and elimination of the genetically and physically unsound as well as everything else that has failed to contribute to the progress of evolution.

The antithesis of this growth-inhibiting form of heat is a falling and concentrating heat-form, which gives life to all those things destined to vegetate, reproduce and separate. It ensures growth and improves the condition of raw materials. The purpose of these cold or cooling substances is to separate the low-grade from the high-grade in the higher realms of evolution and to transmute the latter into that, which the mysterious life- and motive-force gives to all living things. This 'higher inward fall' or 'supra-cadence'<sup>3</sup> has as yet no name. It is an energy-form active in everything, in human beings, in animals and plants as well as in water, air and every organic structure. It accords them physical and spiritual growth, reproduction and upward evolvment and the increase in the quantity of raw materials and their ennoblement.

This organic product of synthesis was hitherto unknown. For this reason it is so named, because it endows all living things with the power to raise themselves up autonomously. It has remained unknown, because the form of motion was not perceived through which everything comes into being that we are able to see or become aware of all around us. This special form of motion will be called 'cycloid motion'. Blood makes use of it in the blood vessels, salts make use of it in plants and natural, untouched rivers avail themselves of it as they flow through the countryside. It is the ur-origin of the fount of qualigen. It is both cause and criterion of all emergent life. It is the living and moving 'connecting link', which weaves the mother-tissues in the womb of the Earth, as Goethe described the performance of this functional entity.

<sup>3</sup> An inward and upward fall into a higher realm of manifestation, either energetic or quasi-material. - Ed.

This energy-form will be consumed, however, if a river is warmed and its water becomes stale and energetically depleted. In this condition dangerous bacterial life, the seeds of decay, arise from bacteriophagous<sup>4</sup> threshold matter, which serve both degeneration and decomposition. On the other hand, if the 'normal' metabolic process is inverted, then the opposite dynamic product comes into being with the aid of 'cycloid motion'. It is the initiator of health, which serves a higher form of development. It is the primal activator that Leonardo da Vinci called 'il primo motore'. It is vitalising force that Paracelsus named the 'life-elixir'; in short, it is the secret of all life and movement to which everything on Earth owes its life and mobility.

Therefore every living thing and all that moves and has its being of its own free will, owes its very existence to this 'cycloid motion'. If it tires and wanes, then physical life comes to an end. Once ended, the period of metaphysical development, the unfolding of the evolutionally older life<sup>5</sup>, the build-up of qualigen or the formation of 'higher influences' begins.

Science and technology scorn and scoff at anyone closely connected to Nature, who does something differently and more correctly and in so doing, reverses the metabolic process so harmful to growth. Quite logically therefore such individuals create the product of synthesis that promotes the build-up of qualigen. Today's science has no inkling that the formative fructigens react to centrifugence and that the seminal substances required for the development of more highly evolved products, react to centripetence. With the aid of cycloid motion and its analysing function, the smothered (de-animated) fructigen is separated from the animating oxygen (for in cycloid motion centripetence and centrifugence operate simultaneously). Science likewise has no idea that 'higher temperature influences' are able to change the characteristic inner properties completely (inversion of charge or potential) and reverse the polarities. In this connection it is to be noted that the formative fructigens become highly active and the debilitated oxygen inactive, due to the simultaneous action of catalytic and oligodynamic factors. With the simultaneous precipitating out of the erstwhile carrier-substance, the opposite product of synthesis comes into existence. It is quality itself in *statu nascendi* - the procreative embryo. This now consumes the counterweighing resistance to weightlessness and in this way develops into the primordial, formative force or the true stuff of levitation. Against this there is no gravity, i.e. everything will be carried aloft with elemental *ur-force*. Those scientists and technologists, who inaugurate the reversed metabolic process, therefore create the annihilating energy-form by the sweat of their brows. In contrast, the bio-ecotechnologist activates the naturalesque metabolic process and generates the life- and motion-promoting counterforce.

<sup>4</sup> Bacteriophagous: see footnote 9, p. 14 -Ed.

<sup>5</sup> Here is meant those entities or systems which exist at a later stage of evolution chronologically. — Ed.



In order to propagate this embryo of levitational matter mechanically, a ridiculously small amount of power is required - about 1/4 hp. Although there are very minor fluctuations, this impulsive and propulsive force always remains constant. As the motive force increases, more and more seminal substances (motion-impeding substances) are generated, whose polarity has been reversed in the process. In consequence the counter-active resistance they would otherwise offer is neutralised.

This diametrically opposed metabolic process or reversal of polarity is conditional on the inactivity of the oxygen and the highly active state of the protoxide. It is achieved through the effects of reactive temperatures, or more accurately, through the action of falling and concentrating heat and rising and expanding cold. The more intense the effect of these 'higher' influences, the more inactive the oxygen and the more aggressive and ravening the protoxide becomes.

The crucial factor in the mechanical propagation of formative embryos is the naturalesque conversion of normal temperatures, whose effects are opposite in nature, into reactive functions. The exploitation of this discovery will completely revolutionise economic activity. It is therefore the machine, which makes the creation of these embryos of qualigen possible by reversing the polarities and functions of the component forces. It is the organ that provides the growth-promoting metabolic process in the organic raw material required for development.

If this concept is taken to its logical conclusion and these mechanically produced, formative embryos are combined with the various media of water, earth, sap and air, then the resultant productivity is truly staggering. From this moment on, everything into which qualigen has been incorporated, starts to reproduce itself and upwardly evolve. It begins to multiply itself qualitatively and to improve itself qualitatively. Logically therefore, the physical and mental condition of all humanity will also be raised indirectly and the standard of living rapidly improved, because the beneficial effects of incorporating additional levitative material into the various foodstuffs in this way, will be transferred to the human consumer. As if touched by a magic wand, even metals, minerals and the organisms of water and air, etc. will begin to flourish, to grow and to ennoble themselves. This is no fairytale, but experimentally proven fact and will change all contemporary economic, social and cultural conditions. In this regard one aspect requires special emphasis: The belief in the unity of mind, body and soul is here confirmed from a completely new quarter.

It is equally important to realise, however, that the suppression of the production of quality matter was no accident, but the result of a shrewd assessment by those who guide our thinking and saw in it the only possible means of dominating the 'common' people. Thus is also becomes understandable,

why people are always so suspicious and so antipathetic towards everything new. But here we are concerned with the whole and naturally it will be said that the whole thing is too improbable to be true. It sounded equally improbable to those contemporaries of Goethe, however, when he asserted that people would one day be able to fly. Now and for the first time they can really do so. Indeed, in the near future what we today call 'flying' will only provoke roars of laughter.

## The Suction Turbine

Viktor Schauberger, April 1958, *Implosion Magazine*, No.114, pp 54-57

The abundance-producing water wheel, which functions using centrifugal pressure, principally consists of a double membrane (see plan and cross-section in fig. 30), which rotates anti-clockwise about a vertical axis with the aid of a low-power drive motor.

The so-called whorl-pipe is wound around the vertical shaft centred on this axis. Viewed from below, the whorl-pipe rotates in a clockwise direction and without any resistance, sucks up the centripetally compressed drive-water.

The faster the drive motor propels the water (which is orbiting about and rotating within itself) through the double-membrane, the greater the quantity of water scooped up by the intake at the lower end of the whorl-pipe, which swirls inwards and upwards in a clockwise direction only to be centrifugated outwards and downwards in rhythmically alternating horizontal and vertical curves, and then centripetated inwindingly again in systems of nozzles. That is to say: Continuous (= one-sided) rotation has a braking effect.

Therefore: Ascent of the water in the whorl-pipe clockwise. This is followed by the swirling expulsion of the water in the double-membrane right out to

the egg-shaped nozzle opening<sup>6</sup> in which, under enormous centrifugal pressure, the drive-water is once again moved centripetally. It then flows at a very high exit velocity into the lower hermetically sealed pressure chamber, which, under hydraulic excess pressure, then impels the water originally drawn up

by the suction whorl-pipe back towards the whorl-pipe intake.<sup>7</sup>

This means: The suctional force must be and so remain the predominant force throughout the whole sequence of motion. The pressure components,

<sup>6</sup> Egg-shaped nozzle opening; This may refer to the egg-shaped cavities above and below the exit nozzles, at the right and left hand sides of the section shown in fig. 32, which actually form a double dough-nut or double toroid pressure-chamber around the periphery of the device. On the other hand, the nozzles may also have the profile of the pipe described in the following patents: Austria: No. 196680 —1951, Portugal: No. 29,729 — 1953, France : No. 1.057.576 —1953, Brazil: No. 43,431 —1953 on p. 107 or the nozzles shown in fig. 29.- Ed.

<sup>7</sup> Although not shown, this infers the presence of an egg-shaped enclosing vessel. — Ed.

which exert the more subordinate pressure, must never act in a purely vertical direction, but always tangentially and at an angle of about  $32^\circ$ . And for this reason: A cycloid-spiral-space-curve is always produced so that the moved mass inwinds from the periphery towards the centre in such a way that the centre of gravity of the unequally heavy (bipolar) masses (i.e. the oxygen - atomic weight 16) is displaced into the centre of the axis<sup>8</sup>. Here the oxygen is cooled (falling [positive] temperature-gradient) and in this condition is encircled and bound (emulsified = consumed and digested) by the hydrogen of opposite polarity, which actually has an upward velocity of about 2 m/sec.

The product of this emulsive process (the ur-procreative act) is diamagnetism. Functioning as levitational force (autonomous resurrective energy), it raises naturalesquely moved water to the highest mountain peaks (viz. true high-mountain springs). The movement of blood and sap is equally the product of the above emulsion = the inner combination (marriage) of opposing bipolar basic substances in order to re-create a unity (individuality) comprised of opposites.

Today's technology operates exclusively with excess pressure and disregards the developmentally important suctional components. What is achieved, therefore, is an increase in pressure, friction and heat. These result in the reversed emulsive effects, which in turn produce predominantly dielectric forms of flow-motion. Since heat is the lowest form of electricity and electricity decomposes water, sap and blood, retrogressive development (= cancer) must ensue all down the line.

Whereas excess pressure oppresses all growth, under-pressure (slight suction or vacuum) - the upwardly impelling diamagnetic force - fosters it.

The faster the double-membrane's drive-motor rotates, the more drive-water is uptaken and the higher the centripetal compression becomes, which then discharges through the pressure nozzles. This intensifies the rotary force in the opposite direction, which must be braked with a dynamo (electric current generator) in order to prevent the rupture of the suction turbine and its disintegration due to constantly increasing centrifugal pressure.

The centripetal compression in the nozzles is regulated by the rate of rotation of the drive-motor. Acting together the two magnitudes of compression and rotation determine the overall power output which, produced by the nozzle pressure, acts in the opposite direction to that of the discharge. This once again provokes hydraulic excess pressure in the hermetically sealed pressure-chamber, which then reinforces the volume of water sucked up by the whorl-pipe.

Since in this rhythmical reciprocity between centrifugal pressure and centripetal suction - therefore through reactive forces - the power increase by

<sup>8</sup> This action is akin to the way that a top or an egg will stand up and spin about the longitudinal axis on its point if spun on its side, or like the weight compensating gyration of a washing machine in the spin-dry phase. — Ed.

the square of the rotational velocity, should the dynamo is suddenly be relieved of its load, provision must be made for regulating the suction turbine by throttling the water supply.

The suction turbine is the first machine that operates with reciprocally interactive reactive forces.

The immensity of the forces released through a properly constructed and precisely calculated suction turbine is attested by the well-known equation for centrifugal force.

If 1 litre (0.264 gal) = 1 kg (2.2 lbs) of water is centrifugated at 10,000 rpm at a radius of 10 cm (4 in.) and suddenly centripetated in the compression nozzles (see sketch - fig. 29), then at a discharge velocity of about 40 m/sec (130 ft / sec), which corresponds to a geological head of pressure of about 400 metres (1,312 ft), repulsive forces are freed, which are equivalent to an increase in pressure of 57,000 kg (125,400 lbs).

This solves the great problem of energy supply simply and cheaply, and what is more, naturalesquely.

What is and remains remarkable is that no-one understands how to transform the cheapest and most powerful reactive force - centrifugal force - into centripetal force (a reactive suctional force), through which the resistance to motion in all today's machines can be transformed into additional power. That is, instead of an efficiency of roughly 10% -12% as has been the case thus far, an efficiency of up 96% can be exploited.

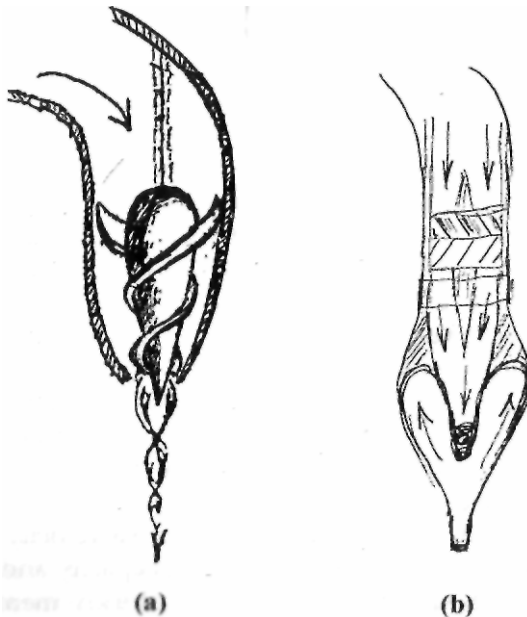

Fig. 29: Sketches of nozzles

## Elaborations on the Suction Turbine

Sherman, Texas, 25th August 1958, Implosion Magazine, No. 114, pp 57-60.

For decades medical science has sought the so-called 'life-curve' in which the two reciprocally interactive component forces of suction and pressure intersect one another in such a way that at the point of intersection an energetic interplay of different emulsions takes place. Pressure- and fire-technology produces and exploits the rising (negative) temperature gradient exclusively and consequently creates excessively strong repulsive forces, which logically act to inhibit development.

While it is true that the falling temperature gradient is known to science, up to now it has not been in a position to activate it. Science has therefore had to put up with braking reactive forces, which become free and active when the medium of water or air is moved along straight paths by physical excess pressures of whatever kind (gradient or pressure-pump). The same also applies to rotary motion, where meanders and sinuosities are absent and in which over-strong frictional, thermal and expansive forces become active. By way of products of reversed emulsions they enforce the emergence of exceptionally decomposive energies. The resistance to motion, the result of an unnatural increase in velocity which rises by the square, is the biological consequence of an unnatural and therefore false type of motion. This is particularly true in the case of all contemporary turbines, which centrifugate the driving medium - water. Moreover; science uses paramagnetic material (steel, etc.), which with an increase in heat (heat is the lowest form of electricity) gives birth to additional decomposive energy (electricity).

As a result of this finding experiments were also made to rotate water in meander-forms made of diamagnetic material (copper, bronze, etc.). Even diamagnetic wood can be used. Out of these experiments arose the double-membrane, which with increasing radius automatically increases the flow-through velocity, if the angle of the alternately disposed slip-surfaces is flattened out towards the periphery.

Fig. 30 (Diagram 1) depicts such a double-membrane (a rotating meander) in which the water is partly sucked, partly propelled upwards by means of a counter-rotating whorl-pipe (= cycloid-space-spiral). The water is then evenly dispersed in the opposite direction, rotated within and about its own axis and in this way the centre of gravity of the flow-through material is displaced towards the centre of the axis.

Here there are two possibilities for increasing the exit velocity relative to the intake velocity as desired and to raise its carrying capacity and tractive force at the same time through specific densation. As already mentioned earlier, this naturally presupposes an improvement quality.

Either an inwinding water movement, therefore the centripetence of the draining water will be achieved with appropriately designed spiral-forms that make use of an existing geological gradient, or the suction-turbine will be rotated by the drive-motor while still empty and once the desired rpm have been reached, the drive-water will then be introduced and sucked from inside towards the periphery with increasing velocity. A suction that extends backwards is thus created, which is produced by the faster outward moving, specifically densifying plug of water. This exits at a velocity, which can be regulated as desired and activates a recoil, which in kinetic terms is the same as the exit velocity.

In order to move air above its boundary velocity, which under a falling (positive) temperature gradient results in its retro-formation into a watery substance, special spiral-helical shapes must be used in order to achieve the same effect described earlier. This spiral-helical form is like a hollow propeller, which once again partly sucks in and partly impresses the surrounding air masses. Here again, the suction components must predominate in order to prevent any pressure and heat stresses. In this manner biologically-correct emulsions occur, whose products are diamagnetically supercharged energies, which levitate and draw up their generating device in their wake (viz. the behaviour of the trout, which cannot be explained mechanically, but only atomically). To emphasise the point once more: Everything is reversible in Nature and hence there are also atomic energies that are not life-destroying, but life-creating. The latter cannot be produced in a cyclotron and so atomic physicists must also be taught that two different things happen, depending on whether a medium, to which ultimately the primary building blocks of Nature - the atoms - belong, is initially subjected to pressure or sucked up to a higher valency.

The attached sketch-diagram is actually extremely primitive. It is enough, however, to enable a halfway naturalistic viewer to get an inkling of what serious and fateful errors are being made by today's atomic experts, for apparently not one of them has ever considered what 'motion' actually is and what biological role it plays. Namely, that death and life depend on the way a medial structure or entity moves and thus vast differences exist between atomic destruction and atomic transformation, for an incorrect motion begets the embryos of death. It is, and was always so, that he who makes a mistake fails to see it, whereas to an outsider, or to a 'layman' as is so often said, it immediately springs to the eye. For a sharp-eyed observer of Nature it is simply incomprehensible that science does not recognise the interconnections that exist between forest and water; that through the disturbance of this bipolarity the differences in potential between the negatively charged geosphere and the positively supercharged atmosphere diminish, causing the groundwater table to sink and the high-grade mountain springs to dry up as a result.

If water is recharged with geospherical energies, then it begins to rise again autonomously and supplies all the vegetation, including man and beast, with aetheric nutritive substances. This happens through the agency of the protoplasm present on every root-tip, which permit the entry of only the most valuable substances, after which the interaction with the diffuse atmospheric oxygen takes place. The end-product of this emulsive process is juvenile-water - demonstrable experimentally - and by extension the formation of blood and sap, if a falling (positive) temperature gradient predominates during this transformative process. However, if a rising (negative) temperature gradient prevails, then fever results, and the decomposition of water, blood and sap is the biological and therefore obvious consequence. By now it will also be apparent to any halfway rational thinker, what deadly perils lurk in the pressure- and heat-intensifying movement of air or water, in the over-warming or over-illumination of organisms of all kinds and why in machines, which trigger a rising temperature gradient, the resistance to motion must increase by the square of the velocity due to cumulative blocking pressures.

For this reason all today's expansion-explosion machines, pressure turbines, etc. destroy life and must be replaced by implosive devices and apparatuses if all humanity is not to perish unconditionally through the mass-murder of every prerequisite for life of whatever kind. For whoever disturbs Nature's household is irretrievably lost.

## Un-Natural Motion - Embryonic Death

Sherman, Texas, USA, 23rd/24th August 1958 (Schauberger Archives).

Suction Turbine:

The essential difference between suction and pressure turbines is as follows:

- (a) The rotation of pressure turbines is induced by the pressure of falling water,
- (b) The rotation of suction turbines is initiated by an auxiliary motor.

In the suction-turbine, the drive-water is introduced once the rotational velocity has been reached sufficient to meet the desired power requirement. Conducted centripetally, this water screws upwards all the more rapidly, the faster the suction-turbine rotates.

The upwardly screwed drive-water is then passed through a double membrane and moved in such a way as to rotate in an anticlockwise direction while simultaneously rotating about its own axis (i.e. about and within itself orbitally and axially), its velocity increasing towards the periphery.

This motion between membranes can be likened to the path of a skier, who transfers his body-weight rhythmically from one foot to the other during his descent, thereby augmenting the speed of descent. The faster the alternation in the displacement of body-weight, the faster the rate of travel (see fig. 36).

The same thing takes place in the suction-turbine, whereby in the course of the above inwinding and by way of almost frictionless motion and acceleration, the drive-water becomes specifically denser as it approaches its anomaly point - 'the biological zero-point'. Now in an almost homogenous condition owing to this particular form of motion, this water is subsequently collected and accumulated in an annular pressure zone (see fig. 33e).

A ring of jet-nozzles is incorporated around the periphery of this pressure ring in which pressures arise, whose intensity increases as the machine is rotated by the auxiliary motor (impulse motor). The apertures of these jet-nozzles must be of small enough size to permit the release of the accumulated excess pressure only. The exiting high velocity 'jet-water' then impacts with high pressure onto a system of specially constructed blades (these have a certain similarity to the blade-system of a Pelton wheel). In contrast to those of the Pelton wheel, however, these are arranged in inverted form and in wreath-like manner.

Once again in a manner akin to the Pelton wheel, the water is expressed laterally virtually free of pressure, and further accelerated by means of a rotating egg-shaped form due to the fact that in this form the radius increases towards the base. This newly accelerated water is then inwound once more, becoming specifically denser in the process, and at high velocity enters an hermetically sealed, but stationary pressure-chamber from the periphery (tangentially). In so doing a hydraulic excess pressure is created, which discharges towards the lower suction whorl-pipe opening - once again in the opposite direction -, the upward angle of which is engineered in such a way that the above excess pressure also remains constant. In other words no more water can be screwed upwards than is desired and because of this a constant rotational velocity is achieved.

If the above rotational velocity is increased by means of the impulse motor, then the quantity of upwardly screwed water also increases, whose naturally induced excess pressure increases by the square in contrast to artificially

created pressures using conventional means. In this case the output increases analogously, but without any excessive demand for more material (fuel), for due to the increasing centripetence of the drive-water, the centrifugal pressure also increases commensurately.

The drive-water, which frees itself from the conducting wall-surfaces during flow - see Prof. Popel's expert opinion<sup>9</sup> - descends almost without friction as a result and, because it seeks a straight passage between the meander-like

<sup>9</sup>This appears on p. 219 of this book. - Ed.



membranes, is impelled by a succession of thrusting, rotational impulses and exits at the closely-spaced wreath of turbine blades (see figs. 33d & 33e<sup>10</sup>)

When the drive-water enters the hermetically sealed pressure-chamber, an atomic retro-pulsive force is additionally created, which is equal in magnitude to the velocity of the exiting water above, because the levitational force mentioned in the previous chapter, discharges in the same anticlockwise direction as the rotating machine. Here too the same counterforce appears, which maintains the steadiness of flow over constantly varying gradients characteristic of naturally regulated riverwaters.

This effect is wholly unknown to conventional science and hence the above motive principle is likewise as good as incomprehensible to any pressure- and fire-engineer, who hitherto has been incapable of triggering the 'falling heat-gradient'. Through the agency of this gradient water can be specifically densified by being inwound in cycloid-spiral-space-curves - like the movement of blood and sap, and in this way can be accelerated to any desired velocity without the need to make allowance for the effect of centrifugal braking pressures,

In this regard it is to be noted that the movement of blood and sap is not the result of hydraulic pressure (the supposed pumping action of the heart), but is caused to move orbitally, axially and predominantly centripetally due to the evolution of potential differences. In emulation of this, the suction turbine therefore faithfully copies the original, natural circulation of blood and sap.

The pressure- and fire-technologist generates kinetic energy by expansive and explosive means exclusively. In contrast, the bio-ecotechnologist does this by indirect means - and in this lies the crucial difference between natural and unnatural and therefore false methods of acceleration. Today's technologist achieves an increase in resistance to motion that rises by the square, whereas the bio-ecotechnologist achieves a reactive effect, which is evolution-promoting, virtually cost-free and increasable at will to any desired intensity.

More precise details can only be explained with the aid of an actual model. These clarifications and supplementary information will be given to the atomic scientists, Chief Engineer, Eric. A. Boerner and my contract partner Mr. Robert Dormer of Colorado Springs at the meeting in Sherman in 14 days' time (this date was set for me by Mr Robert Dormer's representative, Herrn Karl Gerchsheimer). I will make every effort to answer all their various questions clearly with the aid of the above model, so that I can return to my homeland, because my health is suffering greatly from this torrid climate, as has been proven by events of the last weeks, and the doctors too do not recommend any extended stay.

Incidentally it should also be noted here, that the ennoblement of water takes place according to the very same principle. The precision technician, Mr.

<sup>10</sup>See also fig. 21.11, p. 291 In *Living Energies* by Callum Coats and published by Gateway Books 1996.

Renner, who is soon to come here, has constructed several working water-enobling devices. This task Renner will henceforth be able to carry out on his own.

The suction-turbine principle is described in the accompanying sketch. My comment here is that this principle will have to be adapted to every type of machine and each must be treated and built on an individual basis.

Please note that the carrying capacity, increase in tractive force and the amelioration in quality of mixtures of solid, liquid and gaseous or aeriform substances, which carry bipolar charges, are only possible with the aid of the 'falling heat-gradient', i.e. with the form of motion that causes the substance to approach the anomaly point (+4°C - +39.2°F). An understanding of how to trigger these high-grade emulsions is a prerequisite for building a purposeful and evolution-furthering power-producing machine, which corresponds to the primordial life-motor.

## Application for Patent No. 146 141

Viktor Schauburger at Wien-Hadersdorf, Austria, 4th March 1940.

### Processes and Equipment for the Atomic Transformation of Droppable Liquids or Gaseous Substances.

It is known that atomic transformation has been carried out by way of atomic destruction without having achieved any useful economic or commercial results in the process. It is also known that dissociation and recombination, therefore the rearrangement of the atoms, can be effected in the substrate with the aid of catalytic processes. In this regard it has been observed that these processes take place in a characteristic cycle or oscillating rhythm until a new state of equilibrium is established.

The process for the atomic transformation of liquid or gaseous bodies associated with this invention takes this rhythmical tendency during the course of such processes into account from the very beginning. Namely, in accordance with the invention, the aforesaid substances will be subjected to an increasingly rapid flow-motion, during which these substances will be exposed to alternating strong suctional and pressural forces, which results in significant changes to their surface tension.

Furthermore, this invention also makes use of the fact that the presence of certain substances, especially metals such as copper, silver or gold, for example, or those substances collectively termed synthetic resins (plastics), which are decisive for the progress of the vital functions in liquids or gases (air) and whose effect can in part be described as oligodynamic.

Therefore if the said course of motion of the substances to be dissociated is also allowed to proceed oligodynamically, then the severing of the atom it-bonds can be successfully achieved to a large extent and considerable energies freed. These freed energies can readily be brought into new combinations, such as for the further development of the atoms of primary gaseous substances into liquid or even solid formations, or these energies may be drawn off or diverted in some other way.

An example of the device for implementing this process is depicted on the drawing. Diagram 1 shows a section taken through a - b on the top view, Diagram 2 (see figs. 30 & 31). Two circular sheet-metal plates (1 & 2) made of silver-plated or amalgamated copper are press-formed in such a way that they are endowed with a waviform shape and are superimposed on one another in such a way as to create a waviform interstitial space (3). Both plates are maintained at a distance from one another by already known methods. The lower plate (2) is attached to the backing plates (4 & 5), which are insulated from one another by a hard-rubber plate (6). On the upper plate (1) two (three or more) cover-plates are mounted in such a way that they initially rest on the wave-crests of such plate before gradually tapering downwards into the wave-troughs. In this way the narrowing pressure-chambers (8) are formed, whose longitudinal axes run parallel to the circumference. On the inner inclined surfaces of the upper plate (2), narrow slits (9) are incised. The central component (10) incorporates a spacer-ring (22). Spacer-rings incorporating nozzles can be provided in the interstitial space (3). Furthermore, the hollow shaft (22) opens into the cup-shaped component (23), whose inner surface is advantageously fluted, and which has exit openings (24) into the interstitial space (3).

If the device is caused to rotate rapidly in the direction of the arrow (see Diagram 2), then the liquid or gaseous substances entering the pressure-chambers (8) at (25) will be impressed downwards and sideways through the slits (9) into the interstitial space (3), in which a considerable suction evolves, so that the space (3) acts as a suction-chamber.

The whole device therefore represents a kind of multi-stage centrifuge, each concentric wave being regarded as a stage. It can readily be understood that the liquid or gaseous substance present in the pressure-chamber (8), having been subjected to strong pressural forces here, immediately passes through the slits (9) in the pressure-chamber walls and partially expands.

At an appropriate rate of rotation a maximum pressure will be reached, under which a bio-electrical energy evolves, with whose aid the primary combinations of the through-flowing liquid or gaseous substances will split up, whereupon these freed energies can be synthesised into any desired form or be drawn off.

As material for the two plates (1 & 2), silver-plated or amalgamated gold, or synthetic resins (plastics) can be used. If synthetic resin is used and seawater,

for example, is impelled through the suction-chamber (3) an insipid fresh water is obtained as a result of this process.

The arrangement can be so designed that like upper plate (1), the lower plate (2) can also be provided with cover-plates (7), so that the pressure-chambers (8) lie on both sides of the suction-space (3). (see fig. 32)

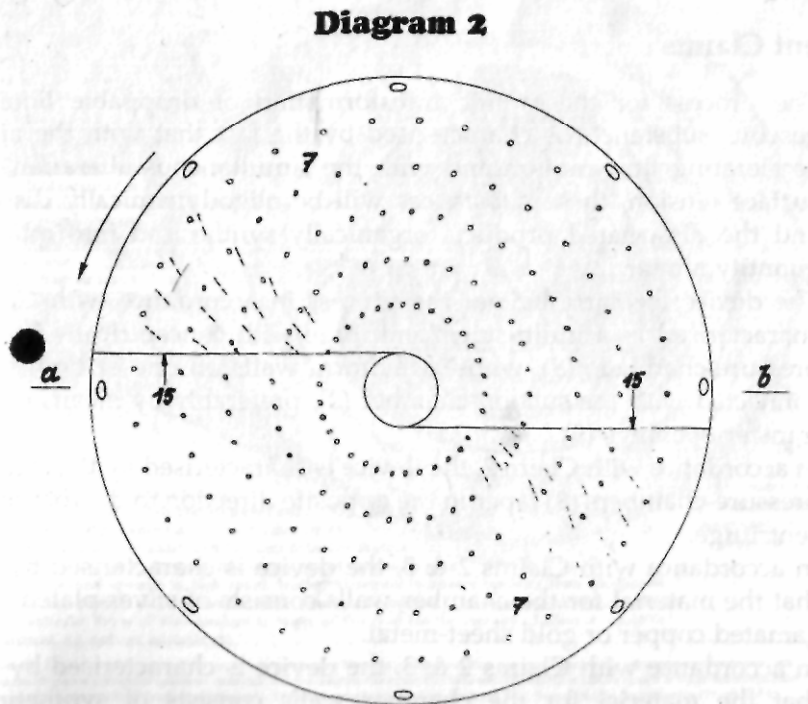
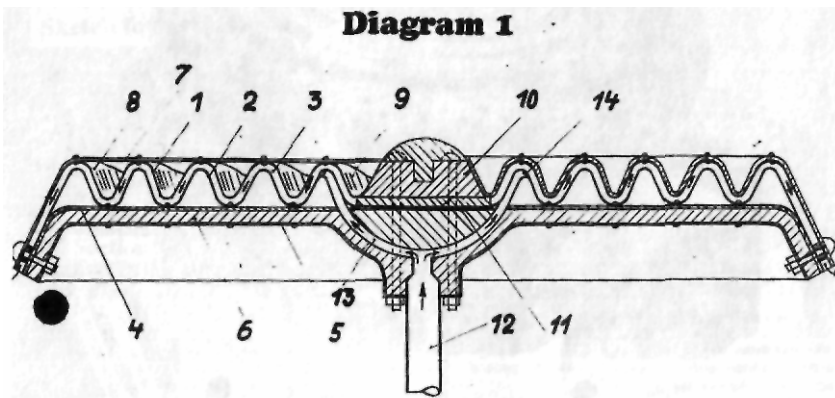

Fig. 30: Repulsine patent No. 146 141

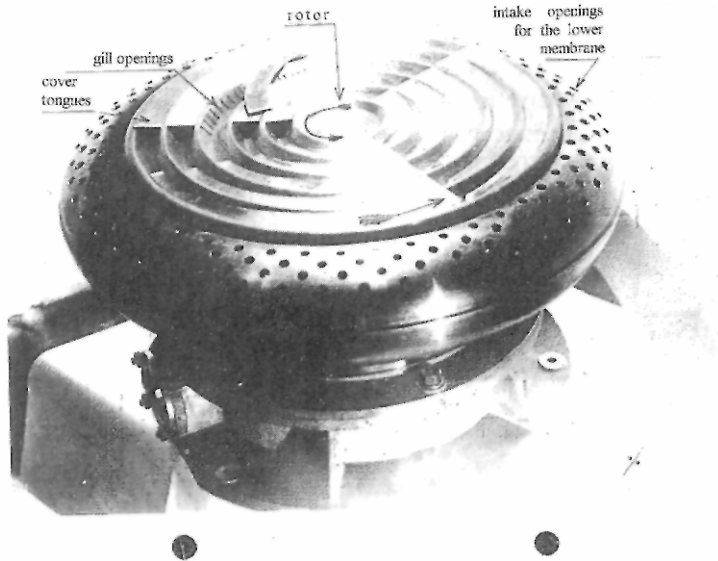

Fig. 31: Repulsine patent

### Patent Claims

1. The process for the atomic transformation of droppable liquids and gaseous substances is characterised by the fact that with the aid of an accelerating flow-motion and with the simultaneous alteration of their surface tension, these substances will be oligodynamically dissociated, and the dissociated products organically synthesised into quality and quantity matter.
2. The device for carrying out the process in accordance with Claim 1 is characterised as a multi-stage centrifuge with concentrically juxtaposed pressure-chambers (8), whose waviform walls on one or both sides are connected with the suction-chamber (3), preferably by means of slit-like transfer openings (9).
3. In accordance with Claim 2, the device is characterised by the fact that the pressure-chambers (8) taper in the opposite direction to the rotation of the centrifuge.
4. In accordance with Claims 2 & 3, the device is characterised by the fact that the material for the chamber walls consists of silver-plated or amalgamated copper or gold sheet-metal.
5. In accordance with Claims 2 & 3, the device is characterised by the fact that the material for the chamber walls consists of synthetic resins (plastics) or partly from synthetic resins and partly from silver-plated or amalgamated copper or gold sheet-metal.

6. In accordance with Claims 2-5, the device is characterised by the fact that the suction-chamber (3) is connected to a supply pipe (12) for the supply of solid, liquid or gaseous ingredients, preferably located on the axis of rotation.

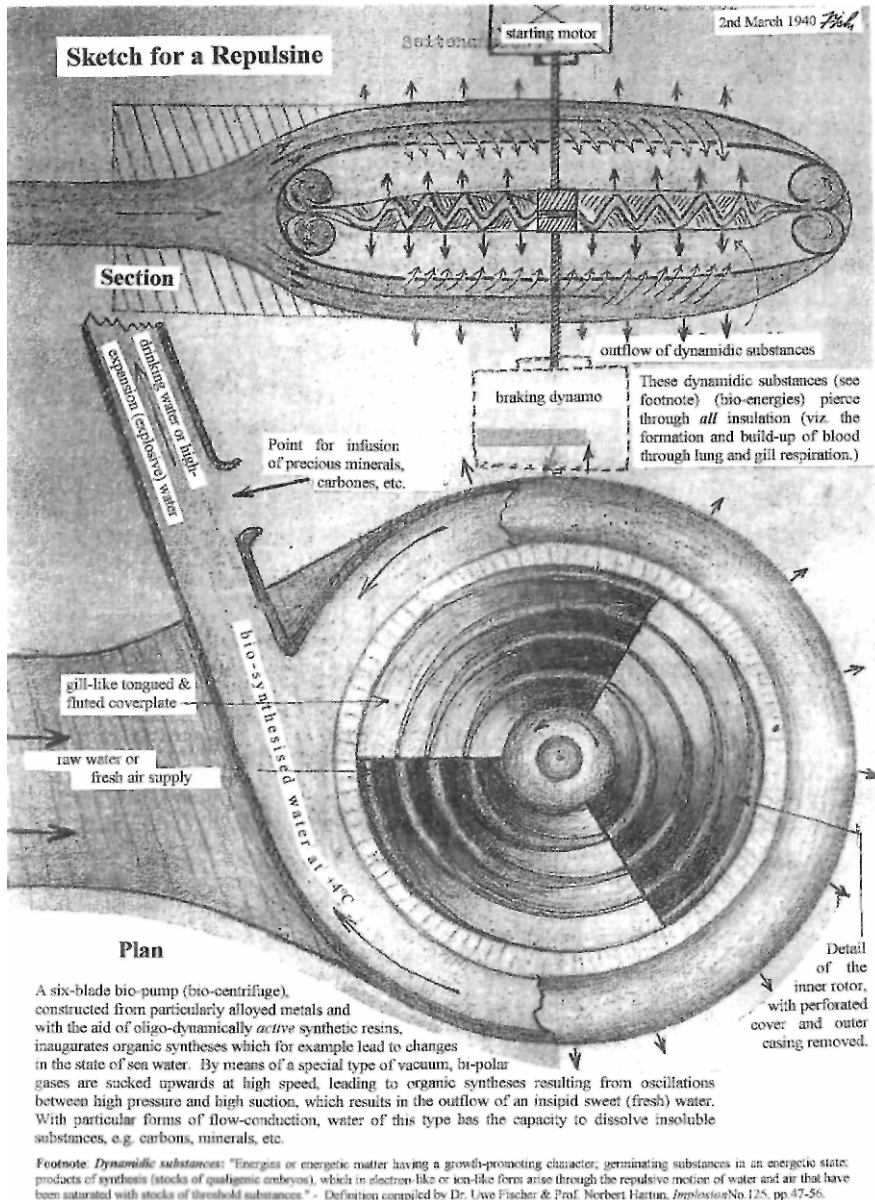

Fig. 32: Repulsine patent double membrane

### Viktor Schauberger's accompanying letter:

To the Reichs Patent Office  
Gitschinerstrasse 97-101,  
Berlin S.W. 61.  
1st March 1940

I, Viktor Schauberger, of Herzmanskystrasse 1 in the town of Wien-Hadersdorf, do hereby apply for patents for the invention described in the enclosed documents and request that I be granted a patent for the same.

Description: "Processes and equipment for the atomic transformation of droppable liquids and gaseous substances".

The sum of 25 Reichsmarks in regard to the costs of processing will immediately be paid to the cashier at the Reichs Patent Office.

Enclosed please find:

1. a carbon copy of this application,
2. two identical descriptions, each with six patent claims,
3. a drawing in duplicate (printed and reference),
4. a confirmation of receipt and pre-paid return envelope.

Signed,  
Viktor Schauberger

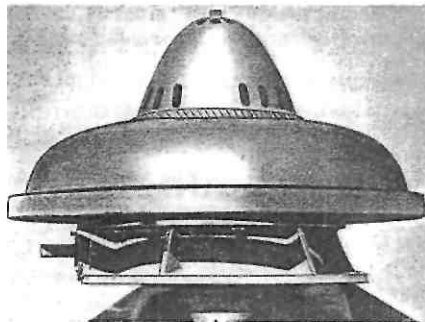

(a) Fully assembled machine on fixed cast metal base. Note power take-off shaft on left hand side of base.



(c) Inner distributor cone removed to expose central portion of upper meander-plate.

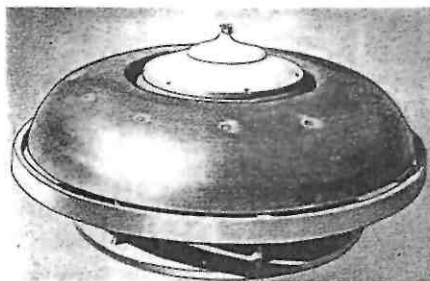

(b) Machine with upper air-intake cone removed to show inner air-distributor cone.

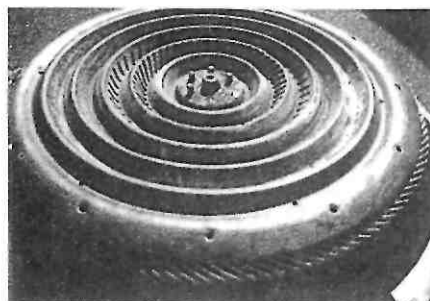

(d) Outer cowling removed to show upper meander-plate with intake slots.

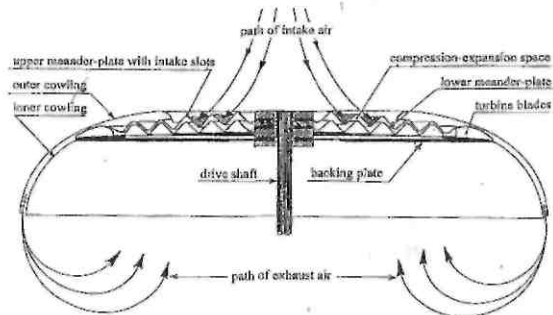

(e) Section through the machine.

### The Repulsine (The Final Model)

**Fig. 33**

Note: Permission to reproduce figs. 33c and 33d was kindly granted by Commander Richard C. Feierabend, USN (Ret).



## Last Letters from Viktor Schauberger

"I must furnish those, who would protect or save life, with an energy source, which produces energy so cheaply that nuclear fission will not only be uneconomical, but ridiculous. This is the task I have set myself in what little life I have left."

- Viktor Schauberger in a letter to Aloys Kokaly in 1953 - Implosion Magazine No. 29, p.22.

### Excerpt from Patent Letter to Munich Patent Office

From Implosion Magazine, No. 87, written in Linz, September 1955.

**B**y reason of research work carried out over more than 30 years, I can provide irrefutable proof that centrifugal acceleration triggers off decentrating, reactive forces. Through the hitherto unnoticed, instantaneous pole-reversal in the lower world of bipolar basic elements, decomposive forces evolve in the media of water and air. This results in the killing off of noble bacteria. In the dying water symptoms of decay appear and pathogenic bacteria come to life, leading to the development of cancer. For this reason the unreal systems of motion taught in all universities are the true cause of cancer. Plasmic disturbances occur, which for lack of adequate replenishment of qualigen, lead to the death of the cells, if metallic toxins form on the cell-membrane. This happens as a result of the accumulation of certain metal ions, to which the oligodynamic extermination of pathogenic bacteria by silver ions is also attributable. These do indeed disinfect the contaminated water, although further possibilities for re-infestation are not removed. On the contrary, if the causes are not correctly combatted biologically, then increasingly developmentally harmful parasites gradually propagate in the further degenerating water, resulting in its total contamination.

The same applies to chlorinated water, since in both cases processes of electrolytic decomposition occur. Georg Krause of Munich was able to control this

so accurately with his electro-catadyne process that the water thus treated was apparently purified bacterially and hence became potable drinking water. In reality, however, water thus treated is not immune to the toxic effects resulting from the formation of increasingly dangerous bacteria. As is the case with agriculture, these have to be combatted with even stronger poisonous sprays. However, if water or air is moved predominantly centripetally in specially constructed and alloyed suction-screw systems (my principal patent claim), then a negative ion concentration evolves of up to 90%, which emulsifies the attendant oxygen. This results in a drop in pressure and heat, due to the specific densation of the naturally moving, through-flowing material. In this case concentrative reactive forces are active. Their products become densified along the longitudinal axis and propagate in a predominantly vertical direction. On account of their enormous velocity, they draw up the device that produces them in their wake.

Seen from this point of view, the assertion by a nuclear physicist in the USSR is correct. He stated that all the available information in classical physics textbooks concerning the attraction of mass is a stupendous mistake, since there is no such thing as an attracting force or mass-attraction. With increasing distance from the Earth, the velocity of the self-purifying, emanating substances becomes so great that an atomic vacuum or vacuity is created behind them. As is known, this also develops behind a fast-moving vehicle and draws a closely-following motorcyclist along with it.

This forward and upward suction also evolves in naturally inwound water, to which the stationary trout owe their motionless stance in fast-flowing water. Even the uplifting of the trout in waterfalls is founded on this action of suction, if the falling water-masses flow naturalesquely and inwind. In all cyclones, typhoons and hurricanes forces are active, albeit hitherto unknown reactive forces, which are the causal agents of this catastrophic upward-wrenching effect. Conversely, every propeller (the archimedean pressure-screw) functions like a dynamo and because of this the mysterious air-crashes over particularly charged or potentiated areas of water and high-grade forests can be correctly understood for the first time, due to the fact that these areas send pressure-sensitive ions aloft.

When the bankers, who were financing conventional hydroelectric power stations and the manufacture of aircraft fitted with propellers or other forms of pressure screw, began to understand my fairly detailed explanations, it was no wonder that such financial institutions and their patent attorneys lost all interest in the granting of patent rights. As an old-age pensioner, I am not in a position to take up arms successfully against the whole scientific establishment. For this reason I have to remain silent, keeping the most pertinent and crucial details from the public until I have managed to find other financiers.

## Excerpts from Letter No. 1 to Josef Brunnader

Written in Linz, 25 /12 /1955

Many thanks for the two letters I found upon my return from the turbine works where my suction-turbine, which has already reached an advanced stage, is being built. Without these practical results, every attempt to return humanity to Nature would be a wasted effort.

The booklet 'Implosion instead of Explosion'<sup>1</sup> prompted the director of a major European turbine-works to ask me whether I would be prepared to receive his scientific adviser and to explain the essential nature of the naturalesque build-up of potential to him, which viewed biologically is the build-up of quality-matter. Shortly thereafter I was sent a book entitled Fundamental Principles of Potentisation Research. From this it was apparent that despite very expensive experiments in this complex matter, no-one had yet been able to arrive at a solution and even the information provided by the anthroposiphist L. Kolisko, based on Rudolf Steiner's instructions, was to no avail,

Apart from me, no one has yet succeeded in the resistance-free acceleration of medial masses by means of a falling thermal gradient. In the turbine-works, where my suction-turbine is being built, it was admitted that the effects of all contemporary pressure-turbine systems, which trigger a rise in the temperature of the through-flow material, become all the more dangerous, the more the supposed efficiency or output is increased.

With this it can be seen what is here involved, i.e. as follows: In order to heal up 1 litre (0.264 gal) or 1 kilogram (2.2 lbs) of water by 1°C (1.8°F) from +14°C to +15°C (+57.2°F - +59.0°F), 1 kilo-calorie = 5.4 horsepower is necessary. If for example, 1 m<sup>3</sup> (35.3 ft<sup>3</sup>) of steam = 1 kg (2.2 lbs), is cooled from about +90°C to +4°C (+194°F - 39.2°F) by moving it in a planetary system of curves, then 86 kcal/sec are freed, which provide additional power in the order of 466.4 hp / sec, discounting minor frictional losses.

With a diameter of 300 mm (1.0 ft) and at 1,000 rpm, a peripheral velocity of 50 m/sec (164 ft/sec) and hence a 50 m/sec exit velocity is produced in my suction-turbine, which corresponds to a geological head of pressure of 500 metres (1,640 ft).

At 1 litre (0.264 gal) of water/sec,  $QxH/100 = 5.4$  hp/ sec per nozzle and second,

where Q = quantity of heat and H = mechanical equivalent of heat. With 10 nozzles = 10 litres /sec (2.64 gal/sec), 54 hp / sec are produced, if these 10 litres (2.64 gal) of water are merely cooled by 1°C/sec (1.8°F/sec), for which only about 0.25 hp are required to provide the required impulse. In this suction-turbine any desired quantity of water can be cooled in a matter of seconds by

<sup>1</sup> Implosion statt Explosion, a book about Schauberg's theories, self-published by Leopold Brandstatter circa 1954. — Ed.

at least 10°C (18°F), say from +15°C (+59°F) down to +4°C (+39.2°F). In this way on average a drop in temperature is produced in the same order of magnitude as the rise in temperature in an ordinary vacuum cleaner, which is driven by archimedean pressure-propellers.

Using a radius of 50 cm (20 in) and a circumference of about 315 cm (126 in) for calculation, then already at 1,000 rpm an effective force is produced equivalent to that required to drive a modern express train. To accelerate it to 80 kph (50 mph), for which about 6,000 hp are required today, I only need about 3 hp/sec as an impulsive force. In my water or air suction-turbine neither air-resistance (sound barrier), nor a thermal barrier exists, because the forelying air-masses are sucked in at the speed of lightning and re-converted into water. The effective power therefore rises quite astronomically, if for example about 30,000 litres (1,059.44 ft<sup>3</sup>) of fore-lying air are screwed inwards in seconds and re-converted into about 30 litres (7.92 gal) of water. For all this about 3 hp are necessary.

By examining the relevant tables showing the reduction in volume that occurs with the conversion of air into water, one can get an idea of the magnitude of the negative pressure that evolves when about 30,000 litres (30 m<sup>3</sup> - 1,059.44 ft<sup>3</sup>) of air are re-converted into a homogenous water precipitate within seconds. If the reverse calculation is made, then it can be seen what force is needed to transform 30 litres (7.92 gal.) of water into a gaseous, aeriform state within seconds. In this regard, if the additional air-resistance encountered by a train at 80 kph (50 mph) is taken into account, then it can be seen how stupidly we deceive ourselves and uselessly squander a vast number of kilocalories to produce the requisite steam pressure to drive such a train at 80 kph (50 mph). With my system, however, only about 3-6 hp would be needed to transform air into water.

About a third of the 27 patents I have been applied for have been granted. The other countries have been assessing them for about 4 years, and will have to capitulate once I demonstrate the improved suction-turbine to them, for owing to their techno-academic education they simply cannot understand the differences. And the same also applies to you, since you too learnt precisely the opposite at school. You must therefore also be patient until you have seen how media of all kinds can be accelerated naturalesquely without resistance, wherein the resistance to motion produced by all technical machines is converted into additional power.

It would therefore serve no purpose were you to act against established science prematurely, because science will become ridiculous once the exact opposite has been proven. I therefore suggest that you continue to be patient for the short time that I require in order to place a fully functional suction-turbine on the lecture table at the next series of lectures to trained biocotechnologists.

At the moment I also have no time for any more detailed theoretical explanations, because work on the turbine, which is proceeding apace, demands my full attention. Very soon the moment awaited with much excitement will come, when turbine manufacturers will have been initiated to the point where they will reproach themselves for having made such a stupid mistake, namely for having produced a rising temperature-gradient in lieu of a falling one, and therefore recognise the self-deception that lies rooted in today's flawed teaching methods.

Please understand that it is for these reasons that I must decline any further theoretical explanations. I wish you a good New Year, which will bring the turning point that everyone has so anxiously awaited, because things simply cannot continue the way they have thus far. As a result there will no longer be any need to fight against those who so far believed they could build up a healthy economy or even a culture with the use of fire. Such a turning point I experienced during the days at the above turbine-works, when the director capitulated completely once he understood the difference between falling and rising temperature-gradients.

## Excerpts from Letter No. 2 to Josef Brunnader

Written in Linz, 15/6/1956

Thank you for your nice letter. That you haven't heard from me for a while was because I've been extremely busy with the construction of an improved home-power generator. (see fig. 34)

As a result of experiments with the first two models, possibilities for their improvement and simplification emerged which were quite surprising, which I will tell you about in more detail in the near future. This will be from Germany, where I am making more rapid progress, because there water scarcity is looming increasingly threateningly and therefore the authorities will be forced to make drastic changes. Indeed, in this whole sphere little can be done without compulsion.

Future home-power generators will use a falling (regenerating) thermal gradient entirely. Interestingly enough, in scientific circles nobody knows of the vast differences that exist between regenerating (refreshing, cooling), and rising and degenerating thermal gradients. By means of the latter, decent ruling reactive forces are activated from the true sediments which contain bipolar trace-elements. These act to decompose water. With the falling regenerative temperature-gradient, concentrating water-forming energies or emanations evolve.

This can be understood as follows: The mechanical equivalent of heat of 1 kcal = 427 kgm of work<sup>2</sup>. If 1 kcal is transformed into mechanical energy in 1 second with the aid of a falling thermal gradient, as normally occurs in the digestive tract, for example, then per kcal (= 1°C or 1.8°F) = reduction in temperature = drop in fever, about 5.7 hp in additional power or energy is made available.

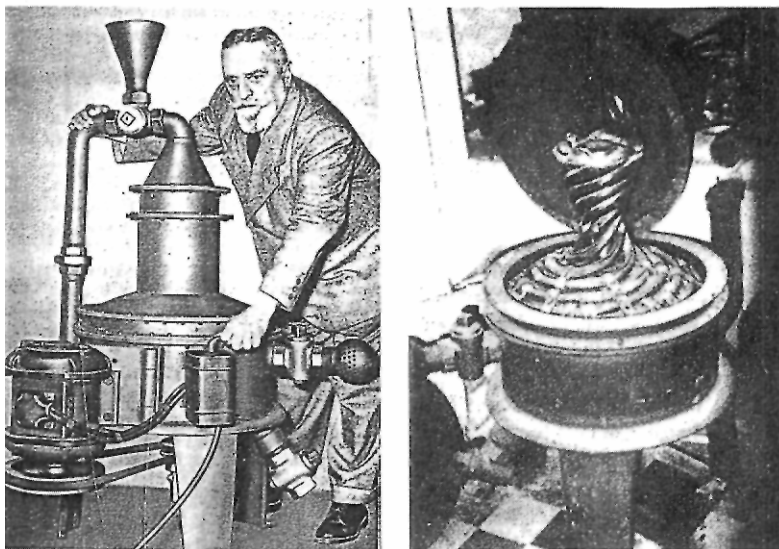

Fig. 34: Viktor Schauberger's home-power generator

Contemporary science makes exclusive use of rising thermal gradients. In this case atomic regressive impulses - or viewed mechanically - reactive forces of recoil or atomic braking forces evolve from the above sources of indifferent dynagen concentrates. Science therefore made two cardinal errors in motion:

1. It created atomic brake-forces with the reversed thermal gradient and
2. It produced reactive forces, which become all the more developmentally dangerous, the faster the rotational velocity of their technically contrived machines.

In my case the more the atomic formative, forward- and upwardly-propelling forces are stimulated by the increasing rotation of an implosion machine, the more the supplementary forces and development-enhancing energies become

<sup>2</sup> kgm: kilogramme-metre	(kgm)	[mechanical]	1 kWh = 367,700 kgm
kilowatt hours	(kWh)	[electrical]	1 kcal = 427kgm
kllocalories	(kcal)	[thermal]	1 kWh = 860 kcal

active. The factor that has been overlooked is the bipolarity - the potential differences - through which the original, causal motion or stimulus is triggered off.

If one now considers that today coal, oil, wood, pressure-turbines, etc., exploit the rising, degenerating thermal gradient and therefore unwittingly generate atomic decomposive forces from the above trace-elements, then it becomes quite evident that throughout the whole chain of evolution cancerous regression will gain sway. The true trace-elements function like fever-reducing medicines, if they are regenerated with the aid of a falling thermal gradient. However, if in any form of motion the rising, degenerating temperature-gradient prevails owing to the supremacy of centrifugence, (e.g. pressure-turbines, expansion and explosion machines), then the above concentrates of reduced matter act as a poison.<sup>3</sup> As this finding can be proven, the very foundation of modern science has been completely undermined, since from this point of view science is the true instigator of cancer.

You can imagine what effect this realisation had in Germany, the ever-alert land of the best technologists. Major industries sent their best specialists and experts, who were unconditionally forced to admit the tragic error, and to realise that techno-academic methods of motion must be immediately prohibited by law, otherwise no recovery is possible. For if the last remnants of water are decomposed due to the effect of degenerative reactive forces, then the consequences are truly unforeseeable.

Recently the Daily Sketch reported that the first English atomic powerstation had to be shut down because of an impending lack of water. Similar reports have come from America, where whole areas are drying out and dust-storms are transforming thousands of farms into wasteland.

For the first time it is now being realised that the practical implementation of Einstein's atomic energies for peaceful purposes is even more dangerous than the enormous consumption of water for today's industrial purposes. And now, as the best hope for a recovery, the League for Human Rights is going to champion my all-revolutionising discovery of how to generate a falling, regenerating thermal gradient. To aid in this recovery, regenerated carbonic acid - the best mountain springwater - can be produced in exactly the same way that it happens in Nature, provided the thermal gradient is present that builds up the concentrating reactive forces prevailing in naturally conserved forests.

A properly constructed and alloyed implosion-machine develops regenerative atomic energies from the indifferent concentrates of dynagen. In the process of producing these, the animating qualigens of 4th- and 5th-dimensinal dynagen can no longer remain inactive and powerful dynamos must be attached in order to produce the electrical resistances. This is the best way to

<sup>3</sup> See "Cadaverine Poison in Ray-Form (Ptomaine Radiation) on p. 28 of this book. — Ed.

prevent such an implosion-machine from running out of control, and in this way the demand for atomic levitational factors can be regulated, which provide the energies that sustain growth. Through my invention the problem of more and more people, less and less and worse and worse food can be naturally and finally solved, if things are merely done in the opposite way to what is presently taught and learnt in all academies, universities and technical colleges.

My new implosion machines produce an almost nine-fold increase in power in comparison to today's machines. We therefore stand directly before an upheaval of a kind that humanity has never yet experienced. Any further comment is superfluous and now at last people are beginning to capitulate unconditionally, because the continuation of current methods of power production will rob our youth of any possibility for further existence, and propel them towards a truly grisly future.

## Excerpts from Letter No. 3 to Josef Brunnader

Written in Linz 20/10/1956

Thank you for your letter of the 18th and many thanks too for the wine you sent me for my 71st birthday. I was not able to thank you earlier, because I had lost your address.

What I already foretold 30 years ago has now come to pass. If humanity does not come to its senses at this final hour, then the very next generation will have to dig for water as hitherto has been dug for gold. The same applies to the realm of energy resources. After a 6-year battle for Patents, the officials at the Patent Office have finally had to give in. Meanwhile I have built the 4th model of the suction-turbine (see fig. 34) and have developed the air-turbine (see fig. 35) to the extent that in principle no further basic development work is necessary.

On the whole I can state after 40 years of research that modern science, founded on precepts and principles going back as far as Moses, was either a tragic error or a deliberate falsification in order to keep the broad mass of humanity in a state of virtual ignorance, for only the stupid or unconditionally dependent are easily governed.

I have now reached the point where with the aid of a falling - regenerative - thermal gradient, I can achieve a nine-fold increase in performance compared to equivalent conventional mechanical systems. The latter make use of a

rising - degenerative - thermal gradient exclusively, thereby reaping a resistance to motion, which increases by the square of the velocity at which the above temperature rises.



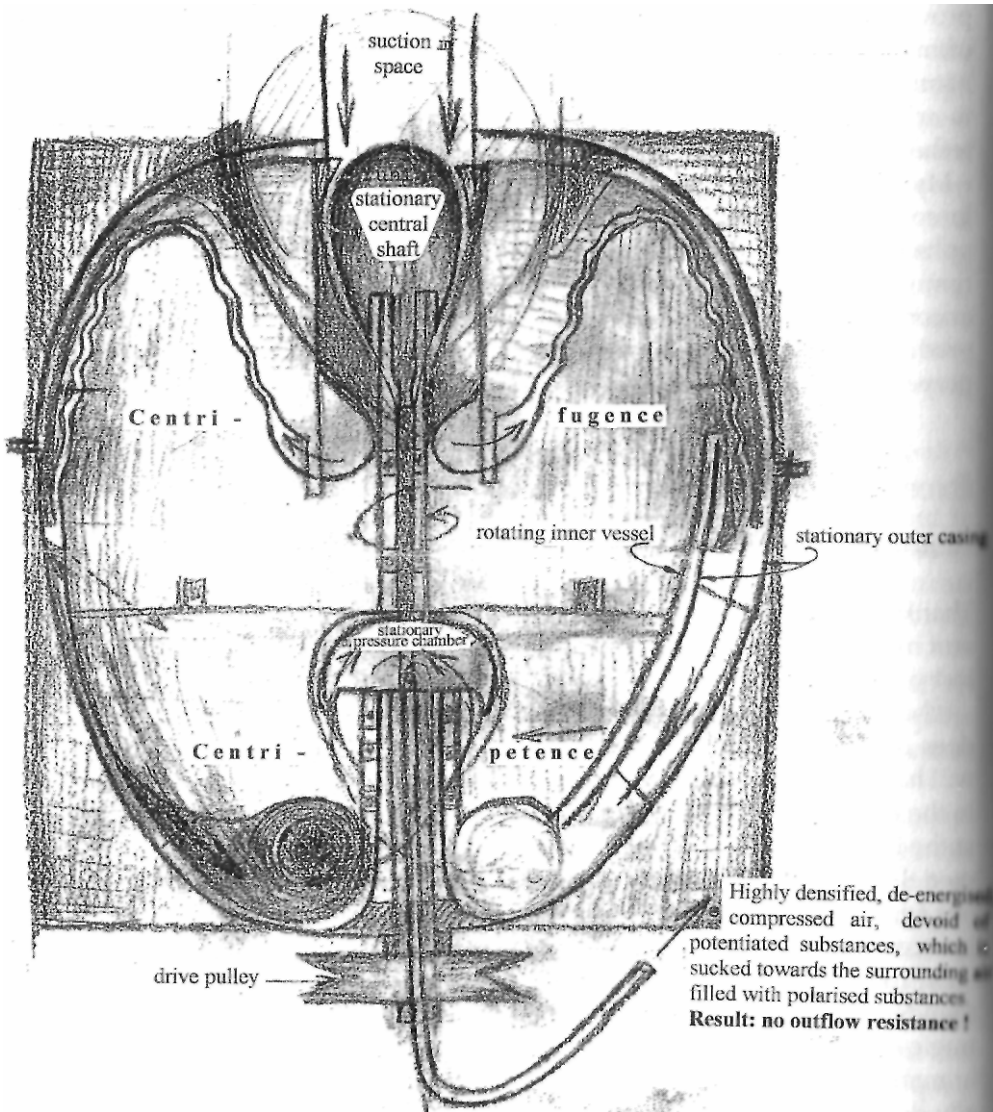

Fig. 35: Possible air-turbine design

If the process is reversed - centripetal forces predominate instead of centrifugal - then per kilocalorie and second about 5.7 hp in additional output is obtained, because in this case the calorific elements inhering in the media of

water and air - so-called 'chromosomes'<sup>4</sup> - are transformed into mechanical power, or in the former case into reactive resistances to motion. And herein lies the error of modern science through which all humanity will be systematically eliminated. If things are carried out unnaturally therefore back to front, then in accordance with inner natural law no advance is possible, but only cancerous regression.

It is the evolutionally older, the rising generation, who will have to pay for the consequences of the fatal misconception of a science founded on rigid, morbid logic. They will never perceive the error, however, because it will only take effect indirectly in the 2nd or 3rd links in Nature's biological chain.

I have often been reproached for not having made implosion technology freely available. Many believe that I know much, but cannot implement what I know practically. In this assumption they err. The reason for my withholding this information goes far deeper. I am convinced that today's leaders of humanity are not stupid enough to have failed to understand how medial masses should be accelerated in order to inhibit the build-up of heat and pressure and hence resistance to motion, which are the obvious result of the expansion of the unnaturally and inversely moved mass.

Without doubt, therefore, there is a definite intention to teach young people upside down methods of working with which they have to mis-earn their daily bread. That is to say, instead of moving forwards, they go backwards all the more rapidly in step with the improvements in the contrary methods of motion. For only thus can today's teaching principles flourish.

Were I to make the naturalesque system of mass motion known prematurely and with it a naturalesque and economic (development-enhancing) *modus operandi*, then the first to get hold of this implosion principle would be those who have no interest whatsoever in any improved social conditions. They would either be held to total ridicule for their hitherto contrary practices, or they would be recognised by their victims as those to blame for this complete economic collapse and therefore punished. In such case, precautionary measures would be taken to ensure that my discovery once again disappeared without trace.

There is only one thing that can be done and that is to explain everything to the victims of this self-deceit or general deception for as long as it takes until

4 Chromosomes: Since the 'calorific elements' consist of substances whose interaction produces heat, i.e. carbone (female) and oxygen (male), the characteristics of homologous chromosomes seems most likely to be what is intended here; These are defined as: "Chromosomes having the same structural features. In diploid nuclei, pairs of homologous chromosomes can be identified at the start of meiosis. One member of each pair comes from the female parent and the other from the male. Homologous chromosomes have the same pattern of genes along the chromosome but the nature of the genes may differ." Meiosis: A type of cell division that gives rise to four reproductive cells (gametes) each with half the chromosome number of the parent cell." — Concise Science Dictionary, Oxford University Press, 1984. — Ed.

they recognise the vast differences that exist between a rising, degenerative thermal gradient and a falling regenerative one. The first serves the build-up of decomposive energies; the second the build-up of formative and levitational atomic forces. It is actually via the agency of counter-polarities, which so regulate the differences in potential, that an increase or decrease in temperature results.

The success or failure of any effective endeavour depends on the possibility of regulating the temperature or thermal gradient. For if with the aid of a falling thermal gradient, 1 kcal is transformed into mechanical power in 1 second, then about 5.7 hp in additional power is obtained from the store of so-called 'chromosomes' contained in the above media.

On the other hand, if a medial mass is moved techno-academically so as to increase pressure and heat, then decentrating reactive energies are released from these dyngen concentrates and act as resistances to motion.

## Excerpts from Letter No. 4 to Josef Brunnader

Written in Linz, 10/8/1957

Please tell those who are harassing you the following: In 1934 I was subjected to an extremely searching investigation when I told Hitler, who had summoned me by telegramme, that today's heat- and pressure-intensifying technology was the greatest self-deceit of all times and that Germany would be finished if the medial structures of earth, water and air continued to be moved techno-academically, i.e. predominantly centrifugally. In this I was confronted by Privy Counsellor Max Planck and other leading lights from the Kaiser-Wilhelm Institute to whom I stated the following:

In the medial structures of earth, water and air there are trillions of reduced fossils - minute planetary systems. These science calls atoms and trace-elements. Doctors call them chromosomes, but I collectively term them 'ur-cells'. If their carrier (medium) is moved axially->radially by means of a 'technical' shaft or axle, then the pressure increases by the square of the speed at which heat increases, in other words, by the square of the increase in friction,

This heat-form is the lowest form of so-called electricity, which for example decomposes water. If the products of this dissociation, hydrogen and oxygen, are recombined, then an explosion of oxyhydrogen gas occurs, resulting in a renewed increase in heat. For this very reason progressively intensifying electrolyses are continually produced in exactly the same way - even if barely detectable - as occurs when an electrical current is conducted into water. Water is only the carrier of the above ur-cells wherein the real process of decomposition actually takes place.

In the first place the inhalation, the attraction and insuction of diffuse oxygen is prevented by the increase in pressure. Having a bipolar charge, the ur-cells therefore suffocate, resulting in a reversal of polarity - the so-called Lenard effect<sup>5</sup> - at the level of the basic elements. This ultimately leads to the rupture of the cells (miniature explosions) and thus to the total disintegration of the ur-source of reproductive, regenerative and multiplying life-forces. As a result trillions of ur-cells putrefy and ultimately whole rivers and seas become polluted due to the emergence of pathogenic life-forms, all of which has been accurately recorded by numerous researchers.

All pressure-, friction- and heat-increasing machines, pressure-turbines, agricultural implements, etc. made of paramagnetic materials only are therefore atom-smashing devices of the first order. Their effectiveness in this regard intensifies in step with the predominantly axial->radial (centrifugal) increase in rotational velocity. This also explains the nascent resistance to motion in all the above machines, which once again increases by the square of the velocity of the above expansive increase in heat.

On the other hand, if the media and their ur-cells are moved predominantly centripetally in a radial->axial direction, then precisely the opposite effects of pole-reversals (naturalesque Lenard effects) occur. These can be measured exactly and trigger an atomic negative pressure in the vicinity of the ur-cells. Equally capable of accurate measurement, this biological vacuum attracts and in-draws the surrounding stores of oxygen and internally binds (marries) it to the unsaturated nitrogen. The product of this in-spire-ation (ur-procreation) - this emulsion-is a diamagnetic formative and uplifting energy. In other words, it is precisely the opposite product of emulsion achieved by contemporary pressure- and fire-engineers.

In this case the reduction in the above resistance to motion reduces in inverse proportion to the increase in reproductive and upwardly evolving energies, which occurs when a falling thermal gradient is triggered instead of the heat-increasing degenerative rising temperature-gradient. Please tell your adversaries that they should produce this re-creative (refreshing and enlivening) thermal gradient with the aid of planetary motion, which will

<sup>5</sup> The Lenard effect: Hereunder some explanatory quotations:

"Philipp Eduard Anton Lenard (1862-1947) Hungarian-born German Physicist awarded the 1905 Nobel Prize for Physics for his investigations of cosmic rays, during which he showed that the atom is mainly empty space. He also made pioneering studies of the photoelectric effect, showing that cathode rays are generated thereby." — Phaidon Concise Encyclopedia of Science and Technology.

Lenard spiral: "A small noninductively wound spiral of bismuth wire, mounted between mica plates, that is used to measure magnetic fields. It depends for its operation on the significant increase in the resistance of bismuth under the influence of an orthogonal magnetic field. The change in resistance due to a magnetic field is measured by connecting the spiral to one arm of a Wheatstone bridge." - The New Penguin Dictionary of Electronics.

Lenard's mass absorption law, "The absorption of electrons moving with a velocity of at least 1/5 of that of light is determined only by the mass of the absorbing matter traversed and is unaffected by its chemical nature." - The Penguin Dictionary of Physics. — Ed.

automatically put an end to any further discussion about who is right. For in this case the internal frictional resistances amount to only about 10%. This results in a 90% increase in effective power, which in the case of techno-academic mass-motion is dissipated through the cumulative increase in degenerative heat. Therefore nothing could be more stupid than to move planetary systems techno-academically, which increases heat and friction! Is this now clear to you? For with atom-disintegrating devices no further development can be expected, whereas with my atom-transforming machines this is a matter of course. To find out how to make the Ur-works function properly again, please study the Austrian patent application over which I have fought a 6-year battle with the sharpest scrutineers of the Patent Office<sup>6</sup>. Like their counterparts in other countries, who took an average of 21 years to make their assessment, they were forced to capitulate and grant me the patents.

## Excerpts from Letter No. 5 to Josef Brunnader

Written in Linz, 5/10/1957

Recently some Englishmen came to visit me in order to make a closer study of the natural production of life-force that arises through the agency of the digestive process. In principle, this build-up of force, which serves to overcome physical and mental heaviness, is the same force that causes the Earth to float in space and provides for its perpetual motion about its diamagnetic longitudinal axis. If the planetary motion of the Earth, water or air is copied, then the build-up of levitational forces proceeds correctly. This form of motion is also exploited by all types of blood and sap. The ancients called it the 'Eternal Flow' (panta Rhei), the eternal, cycloid-spiral-space-curve circulation, which is a circular motion within a circle.

The ur-sources of energy are those energy-concentrates that modern science calls atoms, trace-elements or chromosomes. Viewed biologically and according to their state of being, these are to be understood as the reduced remains of former manifestations of life of all kinds and are also in suspension (float) in water and air in their trillions. According to the type of motion, these are transformed either into pathogenic or apathogenic life-forms, which collectively are encompassed in the concepts of 'life-affirming' or 'life-negating' forces. The fertilisation of these indifferent - neutrally disposed - ur-cells is engendered by the Sun.

In terms of the production of mechanical force from a biological standpoint, what is important about this primordial metabolic process - the 'Eternal Flow'

<sup>6</sup> See description of Austrian Patent No. 196680, p. 105 and "Processes and Equipment for the Conveyance of Liquid, Gaseous or Aeriform Media", p. 107 of this book. - Ed.

- is whether predominantly dia-magnetically or di-electrically supercharged concentrates of dynagen become free and active. This reconstitution of inorganic (reduced) residues of former life into reproductive and upwardly evolving repositories of energy is akin to the manner in which the digestion of undecayed food - fresh cadavers - proceeds. This is not only a process of cold combustion, but also one in which the normal build-up of life-force occurs, which is also diamagnetically super-charged and serves to overcome our own physical and mental ponderousness.

The important factor in this mechanical production of power is whether the media (carrier substances) containing the inorganic sources of energy - the 'ur-cells' - are made to move predominantly planetarily or anti-planetarily. By this is meant techno-academically and therefore pressure-, friction- and heat-intensifyingly. Nature moves the above ur-sources of all life planetarily thereby attaining the 'Golden Middle Way' - a sine-like curve that propagates itself as a (3-dimensional) wave. It is produced when centrifugence and centripence mutually amplify one another. Under such conditions the above 'Eternal Flow of Evolution' is able to take place naturalesquely, because in this process the relatively highest velocity is produced. This is akin to the high speed attained by a skier, when making stem turns during the descent. Through such tangential impulses, the centrifugence appearing in all motion is continually redirected into the straightest possible direction of travel (see fig. 36). Thus the development of the force here in question is brought about in accordance with the equation -  $\text{mass} \times \text{velocity}^2 = \text{energy}$ .

This is like a river, which makes similar stem turns along its meandering course. Its natural developmental path, however, the modern river-engineer truncates, steepens and shortens, thus achieving the opposite effect - excess pressure. This results in a loss of suspended (nutritive) sediment, because it weakens the suctional force. Through the negative pressure associated with this force the provisions for the river's journey - the small particles of



The tangential impulses of the stem-turns of skiers and bends in rivers during descent assist in their straight, forward acceleration.

Fig. 36: The accelerating stem turns of a skier

sediment - are atomised with virtually no application of heat. This is because in the advancing tip of the suction-vortex swirling about its own axis, the relatively strongest centripetal forces prevail, which act to bore out the path in front of it.

If any given flow - a flow of electrical current for example - is natural-ly regulated, then the so-called 'Ohms Law'<sup>7</sup> no longer applies, because such a flow inwinds almost without any generation of heat (super-conductors) and follows the almost loss-less path of the 'Golden Middle Way'. If such a current flow - water for example - is braked by the resistance from the inclined blade of a pressure-turbine, whose angle of attack can be varied to maximise the effect of centrifugal force, then the resistance to flow increases by the square of the expansive increase in heat thus arising. This occurs precisely because the braking blade is made of paramagnetic alloys. In this case di-electric, decomposive energies evolve from the aforementioned trace-elements (ur-cells). These ur-cells are suspended in their trillions in water and air and await the motive in-pulse in order to transform themselves into an octave higher, 4th or 5th dimensional implosive force, which is nevertheless of corpuscular nature. In this instance the levitational, formative and up-suctional, atomic force develops, which the medium accumulates and elevates in order to conduct these reproductive and evolutionally uplifting atomic energies into the interior of the plants by way of diffusion. Through the subsequent interaction of these energies with atmospheric influences, precisely that product of emulsion comes into being, which also endows plants with increased driving force or growth energies.

However, if instead of negative pressure, positive pressure prevails through the implementation of light-induced growth (the exposure of heat-sensitive, shade-loving trees to light and heat), then the structure becomes enlarged due to the abnormally high di-electric forces. Spongy heart-wood and hence genetically defective - red- and white-rot ridden wood - wood cancer is the biological and hence obvious sequel, because heat is the lowest form of the electrical decomposive force.

The same mistake is made throughout the whole chain of evolution through the disturbance of the 'Eternal Flow'. It is therefore really and truly no wonder that the whole process of growth and development will fall victim to cancerous regression, if any medium is moved unnaturally - techno-academically = pressure-, friction- and heat- intensifyingly. This insane form of mass-motion is therefore the true instigator of cancer, because it is itself the seed of

<sup>7</sup> Ohm's law: "The statement due to G. S. Ohm in 1827 that the electrical potential difference across a conductor is proportional to the current flowing through it, the constant proportionality being known as the resistance of the conductor. It holds well for most materials and objects, including solutions provided that the passage of the current does not heat the conductor, but electron tubes and semi-conductor devices show a much more complicated behaviour." - Phaidon Concise Encyclopedia of Science and Technology. — Ed.

decay. This seed is then transferred to all more highly evolved forms of life through the consumption of contaminated water, food and polluted air. Here too, therefore, all that is needed is an additional mechanical, physical or mental (di-electric) motive or stimulating impulse to raise the scourge of this abortive techno-academic age to an acute condition.

## Excerpts from Letter No. 6 to Josef Brunnader

Written in Linz, 15/1/1958

Your letters and activities always give me a great deal of pleasure. What I cannot understand, however, is that you are trying to teach four professorial assistants from the Technical University in Vienna how to do things better. You overlook the fact that implosion-technology will signal the end of pressure- and fire-technology upon which the existence of these four young academics is founded. These fire-apostles would lose their livelihoods if this self-deceit and betrayal of the public were to be replaced by meta-technology.

Recently I had a very disturbing experience. As you know the blind, deaf and arm-less physicist, Burghard Heim, has been occupied for years with the problem of propelling rockets with light-rays. Not long ago I had a visit from his co-worker, Dipl. Ing. Peter Goslich, an aircraft designer - a very sympathetic and intelligent young man of about 30. For years and very unselfishly he has supported his friend Heim's efforts unpaid and he sought my advice as to whether these efforts could be expected to be successful in the future. I said the same thing to him that I said to Dr. Martin, namely, that light-rays act more and more diffractively and motion-impedingly, the further they are from their source - the closer they approach the Earth.

It is upon this property that growth is actually based. Seen from a natural-*esque* point of view, this is to be understood as the re-solidification of what is unsuitable or unusable for the purposes of the next, higher and further development. This has to be expelled and is condemned to vegetate further, so that no genetically harmful matter is incorporated in the further evolution of the fit.

These 'fit' entities, which are capable of resurrection, are products of reduction, i.e. earthly remains of former life. Purified by the planetary motion of the Earth, these are forms of emanation - those diamagnetically supercharged earth-rays called 'Od rays'<sup>8</sup> - which become bound by geospheric water.

<sup>8</sup> Od rays: "Od was a hypothetical force held by Baron von Reichenbach (1788-1869) to pervade all Nature, manifesting itself in persons of sensitive temperament (streaming from their fingertips), and exhibited specially by magnets, crystals, heat, light and chemical action; it has been held to explain the phenomenon of mesmerism and animal magnetism. It forms the second element in chemical derivatives as biod; tin' od ol animal life; cln/niod — chemical od; crystallod — the od of crystallisation; elod — electric od; htliod tha od Oi kha Sun; magnetod — magnetic od; pantod — od in general; selenod or artemod - lunar od, thermod - heat od (Oxford English Dictionary). — Ed.



During these processes of emulsion, water is created as a by-product and under certain preconditions, rises to the highest mountain peaks in order to be able to convey the metaphysical, reproductive and upwardly evolving energies to the plants by way of diffusion. It is the separation of the carrier of these formative and uplifting energies, which cannot exist without a certain physical corporeality, that supplies the root-tip protoplasts (see fig. 15). These only permit the entry of the highest qualities to the interior of the plant as happens in similar fashion in our own bodies through the diffusion of digested, nutritive ethericities into the bloodstream. In this instance as in the other, the supply of diffuse ethericities of the air takes place, the so-called re-*spire-ation* of those geospherically super-charged microzymes, which the doctor defines as red blood cells. These smallest concentrates of dynagen interact with the oppositely-charged cells - the so-called white blood cells, Everything in Nature happens indirectly. The product of this ultimate interaction between fundamental elements, is life itself, which arises anew with every intake of breath by way of naturalesque molecular interaction.

However, if the media (the carriers of life) of water and/or air are moved techno-academically - pressure-, friction- and heat-intensifyingly - then precisely the opposite molecular recombination occurs and with it an unnatural process of emulsion. The product of this is a repulsive (regressively developing) de-centrating (dispersing) and therefore a decidedly destructive energy, which becomes bound in the weakest organisms and inaugurates malformed growth, or the loosening or coarsening of the structure. This is more commonly called cancer, or in a narrower sense, 'leukaemia' or 'anaemia', which quickly promotes the decay of the red blood cells - diamagnetically supercharged energy concentrates - to the benefit of the carriers of decomposive energy.

The same thing happens in over-illuminated, shade-demanding timbers and other forms of growth, and above all in the physically first-born - water, which contains trillions of microzymes. Considered from a more universal standpoint, it is in this way that the decay of water, sap and blood is triggered off, whose germs are transferred to the next higher forms of evolution through the consumption of genetically impaired water and food. After this a slight mechanical, physical or psychic stimulating impulse is all that is required to bring the scourge of this techno-academically, developmentally deformed age to an acute state. Therefore any over-illumination or over-heating of the blood, sap or blood of the Earth - water, causes the relapse of the same and from this point of view the techno-academic movement of medial entities is the true cause of cancer. Conversely, the 'health stimulators' will be brought to life, if these media are moved or stimulated naturalesquely - planetarily - or in exactly the opposite way to the one promulgated and learnt in all academics, universities, high schools and technical colleges.

Whatever manifests itself - even light - is to be viewed as the waste matter resulting from the purification of the relatively highest quality entities, which never manifest themselves physically. For this reason one cannot make use of what serves to shape the Vegetative for purposes of primordial motion. In a word, in an upward direction a falling thermal gradient prevails (positive temperature-gradient) and in a downward direction a rising thermal gradient predominates (negative temperature-gradient). Hence in conformity with inner natural law, cancerous regression must ensue, if the rising thermal gradient is used to create forces that are supposedly uplifting. Dr Martin makes the same mistake, substituting the primary for the secondary. Hence he is also chasing a phantom although from another point of view he is right.

Electricity, whose lowest form is heat, comes into being when the microzymes of the air, or their carrier, are moved predominantly centrifugally (see dynamo - fig. 37). If this medium is moved in exactly the opposite way, i.e. predominantly centripetally, then diamagnetism comes into being, because in this case the falling thermal gradient is activated.

The true stationary trout can therefore only exist in specifically densified, diamagnetically supercharged, high-mountain spring-water. With the aid of their 'choanoid'<sup>9</sup> gill systems, these fish are able to trigger supplementary magnetolytic processes of molecular recombination. It is to this phenomenon that they

Microzymes created  
and atomised through  
slip-pressure !  
Grindstone principle !

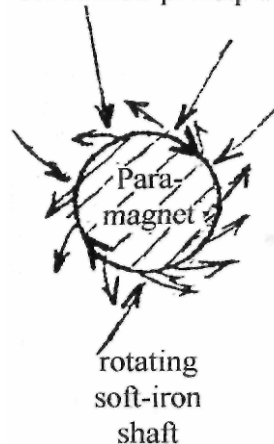

Fig. 37: Rotating paramagnet as dynamo

<sup>9</sup> Choanoid: Funnel-shaped. - Ed.

owe their ability not only to overcome the weight of the counter-flowing water effortlessly but also the weight of their own bodies.

The four young pressure- and fire-technologists, however, can only continue to their lives as long as there are madmen, who believe that culture can be built up with a decomposive-energy-producing thermal gradient. They have to chirrup to the same old tunes or go to the dogs. How therefore can you expect any successful outcome to your efforts from such mentally castrated individuals, where their very existence is in question?

Electricity and magnetism are higher octaves of pressure and suction respectively, and symbolise bipolarity as such. The interplay between these two polarities determines the life and death of what has been imbued by either.

## Excerpts from Letter No. 7 to Josef Brunnader

Written in Linz, 1/4/1958

For years the Austrian Patent Office has disputed the novelty of a system of pipes that eliminates pressure, friction and an increase in heat almost entirely. This movement and the simultaneous cooling of medial structures at equally high velocities can be achieved, through which the introduced gases can also be liquefied. Up to now this could only be done with extremely expensive high-pressure (viz. liquid air). The product of such liquefaction - liquid air - is highly explosive.

Precisely the opposite can be achieved through the displacement of the centre of gravity into the axis. In the process a suctional force evolves, whose suction-tip accelerates ahead, producing a cooling effect. For every 1°C (1.8°F) cooled the volume of the moved mass is reduced by 1/273rd.

The result of this specific densation of medial structures or introduced gases, is a water-like liquid, which functions implosively and generates an atomic negative pressure. This effect can be intensified at will and is also the best and cheapest form of mechanical power. I have called it a 'biological vacuum', which is unknown to science. This utterly new principle for generating mechanical power has therefore remained incomprehensible. It is a principle that serves the build-up of the levitational force, which counteracts gravitation and enables the force of gravity to be overcome naturally.

Since every body loses weight in proportion to the degree to which it is displaced by a specifically densifying medium, it is to this phenomenon that the true stationary trout owes its almost absolute freedom of movement, and is accelerated forward and upwards like a plum-stone, when squeezed between index finger and thumb. In this manner the weight of the body becomes uninteresting (see fig. 38a).

By inverting Archimedes' law the hitherto unnoticed possibility arises for a body to lose weight as its volume is displaced (reduced). This results in the forward and upward squeezing of a tear-drop-shaped foreign body through the sudden densation (liquefaction of the bipolar gas content) of the medium surrounding it. This is to be contrasted with the specific de-densation (rarefaction) that occurs, when medial structures are moved in a pressure-, heat- and friction-increasing fashion - techno-academically. In this case the medium surrounding the foreign body expands and the body falls through it (see fig. 38b).

From this not only can the effects produced by a rising thermal gradient now be understood, but also why tremendous forces are required to counteract this specific de-densation of the surrounding medium. In other words, counter-forces nearly nine times as strong have to be produced in order to overcome the effects of this erroneous form of motion, which increases the heaviness of a foreign body such as an aeroplane for example.

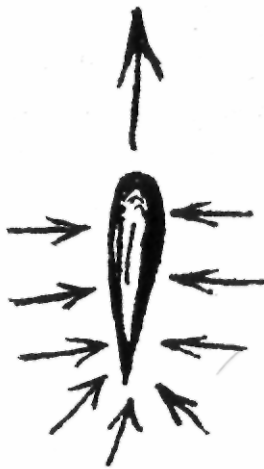

(a)

Forward and upward motion due to the specific densation of the surrounding medium.

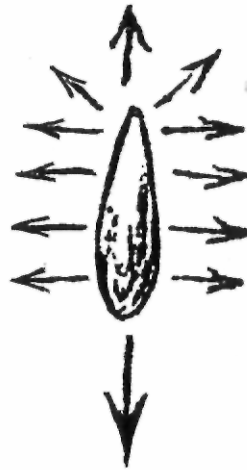

(b)

Backward and downward motion due to the specific rarefaction of the surrounding medium.

"If the 'surrounding' has the same density as the 'surrounded', then there is neither gravitation nor levitation. If the 'surrounding' is denser than the 'surrounded', then the 'surrounded' must rise."

Walter Schauberger - Implosion Magazine No.35, p. 17.

Fig. 38: The effects of relative densities on motion

On the other hand, when a falling thermal gradient is triggered natural-ly, under certain preconditions it specifically densifies the medium of water or air almost instantaneously and liquefies voluminous gases in the creation of a progressively intensifying negative pressure. This functions in the same way as the above squeeze-pressure on the plum-stone. Thus it also becomes understandable how this new type of aircraft acquires almost total freedom of movement like the true stationary trout, which specifically densifies the falling water.

Of necessity, therefore, either this techno-academic method of moving medial structures must be prohibited or, through the specific rarefaction of the various media, the hapless victims of this abysmal stupidity will inevitably perish.

## Letter to Mr 'R'

From Implosion Magazine, No. 82, written in Linz, 4th February 1958.

Dear Mr R,

Thank you for your two letters and enclosures. You conceive the matter to be much simpler than it actually is. Above all, you overlook the fact that it concerns the whole of contemporary, technological science, which believes it can correct Nature and without exception exploits a rising energy gradient. In so doing, it triggers reversed processes of molecular transformation and fosters the build-up of decomposive energies, instead of generating the reproductive and ennobling products of emulsion.

The culmination of this tragic, abortive development was the fissile atomic energy of Einstein.

Thirty eight years ago as I was building the first log-flume and mixed and moved the water in such manner as to trigger a falling thermal gradient, I had no inkling that this was the initial stage in the build-up of a concentrating form of atomic energy. Acting purely intuitively I proceeded further along this course. In 1921 I built the first suction-turbine to provide and light my remote forest-homestead with electricity.<sup>10</sup> With it I achieved an almost nine-fold increase in output. This I deemed to be the most natural thing in the world and once again took the next further step. I utilised this falling thermal gradient for the purposes of re-converting polluted water into noble water - akin to that of high-altitude springs. This water exhibited remarkable healing properties that nobody was able to explain. As time went by I took out over 70 patents, but not being much of a businessman, I was unable to exploit them

<sup>10</sup> See Jet Turbine Patent (No. 117749) in *The Water Wizard*, Vol. I of the Ecotechnology series, p. 206. - Ed.

commercially. Eventually the doctors and pharmacists became aware of these mysterious healing successes. Just as they did Priessnitz and Kneipp, they accused me of charlatanry and one day the Austrian State Police appeared and confiscated my apparatus.

I then went to Nuremberg, where a laboratory had been placed at my disposal. There I discovered that what I was actually concerned with were emanations with different functions. There are pure rays, which animate and enliven. There are also types of rays that debilitate, and lastly there are indifferent rays, which serve to build up or decompose water (see fig. 23 & figs. 2-3). The first are released from so-called microzymes when water moves under a falling thermal gradient. The second are activated when water moves under a rising thermal gradient, whereas the former build up the corporeal elements, which bind one thing with another.

From that moment I recognised the erroneous form of motion employed by the whole of science and exposed it for what it was. On doing so, I stumbled into a veritable hornet's nest and began to feel the full force of the omnipotence of my scientific adversaries. I was challenged to provide proof. Whenever I did this, I was robbed to such an extent that there was no other course was open to me other than to remain silent once more. In the February issue of 'Weltgewissen' you will be able to read that these devices, which the Austrian State Police took from me, are now being manufactured in Germany with enormous success. This has happened to me twelve times. Every time I had something fabricated, all I was given were the leftovers, while the best part was retained and exploited commercially by others. Or the apparatus was never made public (see the suction-turbine), although I had paid all the agreed development costs myself. Subsequently such large sums were demanded of me, which lay far beyond my capacity to pay, and the machines I was struggling to build were withheld as security against payment.

I then began to work covertly and in this way succeeded in producing workable machines. I then first became aware of what I had discovered, namely higher-grade atomic energies. At this stage "Demonstrate it!", "Prove it!", "Let it be examined!" was and is always demanded. If I concur, then all is lost. If I do not, however, then I am a fraud. 'M' requested that I show the gadget to him and some of his friends and that I hand over the patents to the VSB, otherwise he would cancel the public demonstration. "Do it then !", I replied. Whereupon he withdrew his threats.

Then along came a major German industrialist with his scientific advisors. He investigated the process and found it in order. Statements were made expressing readiness to proceed with fabrication and cost evaluation and then, yes, then one will just have to wait and see. All they are, are empty promises, never kept. Now representatives of the U.S. government have announced themselves. They too want to see and evaluate everything first,

and then, only then will it be considered what might be done. I requested a provisional agreement, which would only come into force once I proved that I could achieve significantly increased output. This was rejected. First see, then negotiate and the outcome was always the same. Professors also want first to see, evaluate and then, aye and then take over.

My dear Mr R, I have now reached the point where they can all kiss the place where my spinal column terminates. I am old and seriously ill. My only concern now is for all the poor children, who are faced with a grisly future. If I reveal everything, it will only be hushed up, because it not only involves the whole scientific establishment, but also the doctrines of the church. All power-politics will collapse once the truth emerges that science is the actual causative agent of cancer.

I have no need of the VSB, neither as curiosity seekers, nor even as those hungry for business. I know that lot only too well ! This is how the matter stands, my dear Mr R. I intend to return to the forest once more, there to die in peace. The whole of science and all its hangers-on, are nothing but a band of thieves, who are suspended like marionettes and must dance to whatever tune their well-camouflaged slave-masters deem necessary. In this situation only a frightful catastrophe may perhaps bring about order. In the achievement of such generalised order at least 90% of humanity will fall victim. They will perish because of water and blood decomposition (cancer). The final victory will be achieved by the Russians, who are closer to Nature and who, according to the Pfalzer Tageblatt of the 14th January 1957, are nearest to the overcoming of gravity. This, however, will only be understood by the West when it is already too late.

You, Mr R, are still young and will live to see this. I know it, but can do nothing to change it myself. Please don't attempt to persuade me otherwise. In order to put their remains to the best use, pigs and human beings are only weighed after they are dead. One day in the near future, you will hear that this old turnip is no more.

Kindest regards, Viktor Schauburger.

13.

## The Popel Report

### The Preliminary Investigation of Helicoid Pipes: Foreword

Extracts from the Foreword to the Report concerning the  
Preliminary Investigation of Helicoid Pipes with Various  
Forms of Wall Structure

Stuttgart University of Technology - Professor Franz Popel.

#### SUBJECT:

Negotiations on the 9th of February 1952 at the Stuttgart University of Technology concerning investigation of prototypes of straight and spiral helicoid pipes of various materials developed and made available to the Stuttgart University of Technology by VIKTOR SCHAUBERGER.

#### WITH REFERENCE TO:

The report of the Institute of Hygiene at the Stuttgart University of Technology Stuttgart, dated the 15th of March 1952.  
(Director: Prof.Dr.-Ing.habil. Franz Popel)

- 1.0 Present at these negotiations on the 9th of February 1952 at the Institute of Hygiene at the Stuttgart University of Technology were:
- 1.1 Prof. Dr.-Ing. Franz Popel.
- 1.2 Assistant Secretary KUMPF, as representative of the Federal Ministry for Water Resources in Bonn.
- 1.3 Viktor SCHAUBERGER, Salzburg, Austria.



- 1.4 Dipl. Ing. Walter SCHAUBERGER, Bad Ischl, Engleithen, Austria.
- 2.0 The object of the negotiations was the comprehensive complex of themes and questions concerning:-
- 2.1 Water supply and its scientific and technical problems.
- 2.2 A paper of Viktor Schauberger's, with particular reference to his previous research findings, developments, projects and the performance of completed projects in the sphere of near-natural hydraulic engineering, including a number of observations, explanations and assertions concerning agriculture, forestry, water and energy supply.
- 2.3 A short paper of Walter Schauberger's concerning non-Euclidean (Gauss) concepts in Nature, the basic assertions of quantum physics, and facts incorporated in the Theory of Relativity, which taken altogether, emphasise the centripetal dynamics of Nature's energetic and resonant processes with their universal sphere of action.
- 2.4 Professor Popel made a statement opposing Viktor and Walter Schauberger's statements and opinions. He expressed the view that the crucial areas of technology were founded on the legitimacy of classical mechanics and hence the laws governing the flow of liquids and gases should also be dealt with from this point of view. Moreover, it had likewise been determined that in hydraulic engineering optimal results had been achieved with Euclidean elements. He could therefore state at the outset that Schauberger's desired investigation of such pipes, would achieve no useful results for technology. Also, in view of the relatively high costs to Schauberger arising from such investigations, he asked permission to withdraw from this task.
- 2.5 Kumpf agreed unreservedly with Professor Popel's opinion and added that Bonn was interested in this scientific investigation inasmuch as it would at last put a stop to Viktor Schauberger's unqualified attacks, which were directed primarily against the sphere of water resources management. Bonn would therefore make some financial contribution towards the costs of the investigation.
- 2.6 Thereupon Professor Popel declared that his institute would carry out the various investigations on straight and rifled helical pipes and that the results of the investigations could be expected in about two month's time, Viktor Schauberger's request that his son, Dipl. Ing. Walter Schauberger, be present at these important series of tests, was accepted by Professor Popel.
- 2.7 The scope of the investigation and its subsection concerning the format of the series of experiments and the catalogue of questions to be settled, was fixed. This referred, with significant reductions however to the complex of questions, namely points 1 to 5 quoted in the investigation report.
- 2.8 In point 6, the crucial area which Schauberger stressed and wished to be settled, namely "Technical hydraulic engineering and its destructive

consequences', was on the one hand deferred by Prof. Popel, and on the other, rejected by Kumpf as serving no purpose. Point 6 was concerned not only with the specifically targetted formulation of questions, attempts at interpretation and facts, but also empirically substantiated findings. These concerned such aspects as:-

- (a) That to the most massive intrusions into Nature's biological balance, must be added the purely mechanical correction of river embankments. (Proof: The regulation of the Rhine, Danube and other 'hard-edged' rivers and streams.
- (b) That despite the consequential damage occurring everywhere due to this unnatural and therefore incorrect regulation of watercourses, why is this practice still continued?
- (c) That indisputable evidence (and these are not merely assertions or opinions) show unmistakably, that the execution of such erroneous corrective measures in relation to embankment works, i.e. mechanical methods of regulation, results in an even more drastic sinking of the watertable, a far more widespread drying up of springs and the increasing disappearance of water.
- (d) That a farm report (Third Reich) dated 4th of February 1939 indicated that the repercussions due to the vanishing of the watertable had become so evident, that development of steppe-land over large areas was greatly to be feared. The already projected re-routing of rivers mentioned in this report and their attendant dams for the storage of irrigation water, would only accelerate steppe-development and desertification.
- (e) The smallest causes have unforeseen effects in Nature.
- (f) The warming up of water through unnatural motion and containment leads to the loss of its carrying capacity and tractive force, and in further consequence, to its disappearance.
- (g) Despite its slow rate of flow (meander), naturally flowing water has a greater carrying capacity and tractive force, which decrease, however, with steep, technically contrived gradients.
- (h) Nothing is more absurd than to intensify the geological gradient by a shortcut, because in such instances, due to its own weight, the water throws itself out of its course and the preconditions for natural motion diminish.
- (i) Hydraulic engineers have neglected:
  - the interplay between the tractive force and the carrying capacity of water
  - the normal profile arising spontaneously from a bio-dynamic form of motion

- the rotation of water about its own axis, which again is the result of a normal profile.
  - the proper insulation (from heat, Sun, etc.) through the natural placement and deposition of the layers of sediment.
- (j) The natural regulation of a watercourse is never possible through mechanistic restructuring or realignment of the riverbank.
- (k) Water, sap and blood are all accumulators and transformers in which analyses and syntheses constantly take place. These further intensify, the more water, sap and blood are caused to move in a natural way. In the course of this, the outer velocity has almost no effect, whereas the inner balancing velocity plays a very important role.
- (l) The origins of carrying and tractive power, at otherwise equal velocities, lie in the water's inner metabolic processes.
- (m) Quantity can be transformed into quality. This requires a corresponding organisation of the material, in form as well as in qualitative relationship.

Dipl. Ing. Walter SCHAUBERGER

## Report Concerning the Preliminary Investigation of Helicoid Pipes with Various Shapes of Pipe-Wall carried out at the Institute of Hygiene at the Stuttgart University of Technology, Germany.

Director: Prof. Dr. - Ing. habil. Franz Popel.

During negotiations on the 9th of February 1952 the Biotechnical Study Group made various prototypes of straight and spiral helicoid pipes of different materials available to the Institute of Hygiene at the Stuttgart University of Technology in order to clarify fundamentally the following problems:

1. Can water be brought into a multiple in-winding, convoluting, spiral motion when flowing through pipes?
2. Does the form of the conducting pipe play a decisive role in the attainment of this convoluting motion?
3. Does the material of the pipe play a decisive role in achieving this in-winding spiral motion?
4. Do changes in the molecular structure of the water occur during this in-winding flow process?
5. Could these in-winding flow processes be utilised in the prevention of pipe-encrustation?

## To Question 1:

### The Multiple In-Winding, Convoluting Flow Process.

If water containing coarse suspended matter is first stirred around in a glass beaker and afterwards left to rotate by itself, then the suspensions concentrate themselves in the axis of the rotating cylinder of water caused by the stirring. This well-known natural phenomenon is already being evaluated technically in the circular sand-capture machine by the Geiger Company, Karlsruhe and in the 'Hydro-Cyclone' of the Stami-Carbon Company for the separation of suspensions from water. In both cases the contents of the circular containers is caused to rotate by the tangential supply of the liquid, which can be considered to be the cause of the self-ordered concentration of suspended matter in the axis of the vertically rotating cylinder of liquid. However if water is conducted from a large container into an inlet pipe and is set in a faster or slower rotation above this, a suction funnel is formed, which is deeper or shallower according to the velocity of flow prevailing in the outlet pipe. Attentive observers can often watch the formation of such vortexial funnels at the outlets of basins and baths. The spiralling of the water in the pipe, evolving from the inlet in the direction of the outlet pipe and the forward motion of the water in the outlet pipe itself, now generate as a result of these reciprocal influences, a flow-through process composed of the simultaneously combined effects of several 3-dimensional space-curves, which can be made visible in the following manner.

Water flows from a vessel with a constantly maintained water level (levelling vessel) into a glass pipe of 40 mmOID<sup>1</sup> and onwards by means of a rubber hose of 19 mmOID to an overflow. Whereas in Test Stand 1 (Diagram 1) the levelling vessel and the water supply were so arranged that only a very weak spiralling motion at the inlet of the observation pipe was able to develop, in the case of Test Stand 2 (Diagram 2) the build-up of spiral motion was intentionally assisted by the trumpet-like form and a tangential inflow of water. The 40 mmOID test pipe with a flow section of 0.125 dcm<sup>2</sup> was supplied with a quantity of water between 0.2 and 0.21 litres/sec, so that this would flow through at a calculated velocity of 1.6 to 1.68 dcm/sec. This already lies within the region of turbulent flow. A thin silk thread, weighted at the end, hanging straight down into the test pipe at a state of rest, was set

<sup>1</sup> To aid readers unfamiliar with the metric system of measurement and to avoid over-complicating an already complex text by inserting Imperial or US equivalents, the following correspondences have been provided by the editor:

1 litre (l)	= 0.22 imp. gallons	= 0.26 US gallon	
1 millimetre (mm)	= 0.03937 inches	1mm <sup>2</sup> = 0.00155 in <sup>2</sup>	1mm <sup>3</sup> = 0.00006102 in <sup>3</sup>
1centimetre (cm)	= 0.3937 inches	1 cm <sup>2</sup> = 0.155 in <sup>2</sup>	1 cm <sup>3</sup> = 0.06102 in <sup>3</sup>
1 decimetre (dcm)	= 3.937 inches	1 dcm <sup>2</sup> = 15.5 in <sup>2</sup>	1 dcm <sup>3</sup> = 61.02 in <sup>3</sup>
1 metre (m)	= 39.37 inches (3.28ft)	1 m <sup>2</sup> =10.764 ft <sup>2</sup>	1 m <sup>3</sup> = 35.315 ft <sup>3</sup>

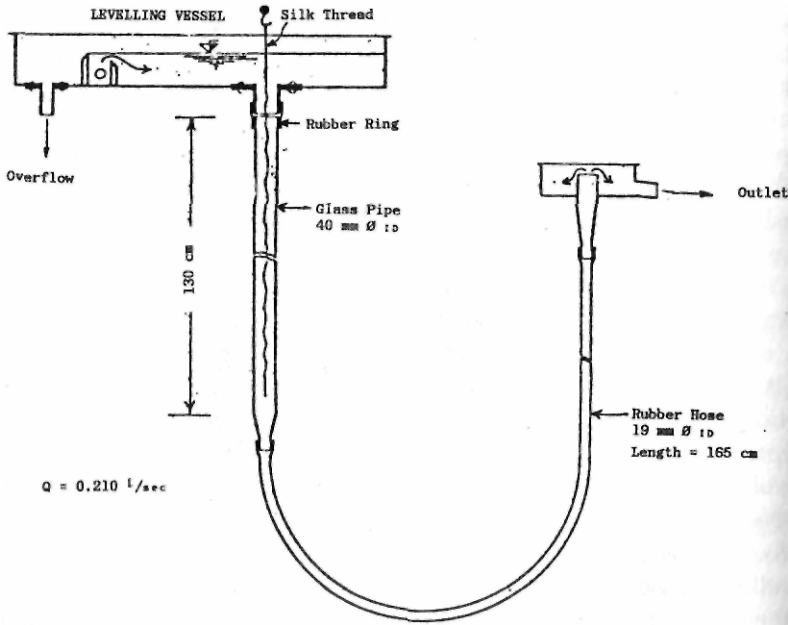

Institut für Gesundheitstechnik an der Techn. Hochschule Stuttgart				
Des: <i>Uf</i>	Dat: 20.3.52	TEST STAND No. 1	Zeichn Nr.	DIAGRAM 1
Des: <i>Uf</i>				

Diagram 1

in a slow rotation corresponding to a slightly convoluted 3-dimensional space-curve by the flow of water through the pipe. In Test Stand 2 the curvature of the thread was greater than in Test Stand 1, due to the greater spiral motion at the inlet. Since apart from this, it was observed that fine hydrophobic suspensions, very evenly dispersed over the water surface with the aid of a finely meshed sieve, were concentrated into little clusters along the 3-dimensional space-curve denoted by the thread, it is thus demonstrated that a flow in the pipe is developed, which follows a 3-dimensional spiral curve and simultaneously rotates about the axis of this space-spiral. (Proof: Curvature and rotation of the silk thread.) This is also confirmed by the fact that the air entrained by the water becomes concentrated along the 3-dimensional space-spiral in the pipe and which, according to the size of the air bubbles in the rotating flow of the water about the space-spiral, either accompanies the water or rises upwards again.

In order to be able to examine this multiple in-winding flow more closely, the behaviour of three silk threads, each suspended from the corner of an equilateral triangular spacer-block, was investigated. Although the position of these threads was fixed by spacers at the middle and at the lower end as well, an entwining of the three threads could be observed, when water flowed through the pipe. In addition, the threads in this new arrangement were always forced into the region of the 3-dimensional space-spiral axis, despite their weighting and spacers. Due to the greater combined stiffness of the three entwined threads, which were even more encumbered than the single thread by their spacers and three end-weights, their curvature was naturally somewhat less than in the case of the single thread. In order to check whether the entwining of the three threads was not merely attributable to the rotation of the spacers caused by the rotation of the water at the inlet, the spacers were removed from the middle and the bottom. In this instance too, the entwining of the three threads and their alignment along a slightly curved space-spiral was achieved. It is thus clearly demonstrated, that the entwining of the threads cannot be ascribed to the rotation of the uppermost spacer, but only to the multiple in-winding flowing motion of the water.

This multiple in-winding flow process inside the pipe is superimposed by a second equally space-spiral-like, curving, peripheral motion as well. This phenomenon was made visible with the aid of iron filings. It was noticeable, that during the flow-through of the water in the pipe, the pitch of the strongly curved space-spiral is not constant, but gradually becomes greater and at the same time a concentration in larger agglomerations takes place.

These flow processes, which superimpose each other in pipes and which have been detected for the first time with the aid of the demonstrative experiments described above, must still be thoroughly investigated in relation to their formation and effect.

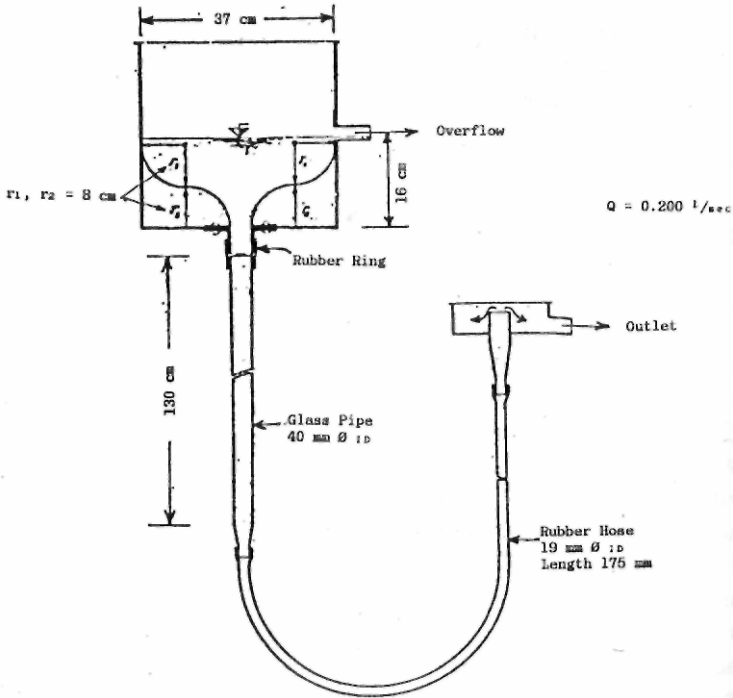

Institut für Gesundheitstechnik an der Techn. Hochschule Stuttgart			
Doc: <i>clp</i>	Doc: <i>muft</i>	TEST STAND No. 2	Lehrno Nr.
Dep: <i>Y</i>			DIAGRAM 2

Diagram 2

Were only centrifugal forces here active, then the silk thread hanging down the centre ought to have been drawn towards the exterior. Also such forces could never bring about an entwining of the threads along the weakly curved space-spiral. Moreover it would be impossible for centrifugally acting forces to twist the three silk threads suspended in the outer zones of the pipe into a single thread, which then further accommodates itself to the space-spiral-like curved axis. These phenomena can only be brought about by centripetally acting forces greater than the centrifugal force.

The multiple in-winding flow can therefore only be attributed to these centripetally directed forces initiated by the system of flow itself and which have been observed and clearly detected for the first time.

In addition, it can be concluded from the variable pitch of the strongly curved space-spiral and by the observed flocculation and migration of the particles of matter in the centre, that the centrifugal forces decrease with the flow-through of water in the pipes and the centripetal forces which overcome them are always of the same magnitude and accordingly increase their effect gradually in relation to the centrifugal forces.

The detected flocculative processes, however, cannot be attributed to the influence of mechanical forces alone. According to prevailing ideas concerning the coagulation of solids, it can be assumed with the greatest certainty, that the agglomeration of solid particles occurring in the course of the flow process, is triggered off by the effects of electro-physical forces.

The flowing motion of water in straight pipes, made visible in various ways, thus clearly proves that at the inlet of these pipes a greater or lesser spiralling motion develops, which in turn triggers off an in-winding flow along a space-spiral and which is additionally superimposed by flows along more strongly curved space-spirals.

To Questions 2 & 3:

**The Influence of the Form and the Material of the Pipe on the Development of In-Winding Flow Processes.**

The superimposing flow processes detectable along either a weakly or a strongly curved space-spiral must strongly impede each other through the formation of vortices in the fringe areas of both motions, which differ in direction and velocity of flow. Therefore as a logical conclusion arising from this observation, an increase in the output of the pipe could thus be anticipated in the instance of a favourable limitation of the mutually impeding flow processes due to vortex formation.

Since in their rhythmically oscillating form the helicoid pipes are aligned to the course of the strongly curved space-spirals automatically evolving during



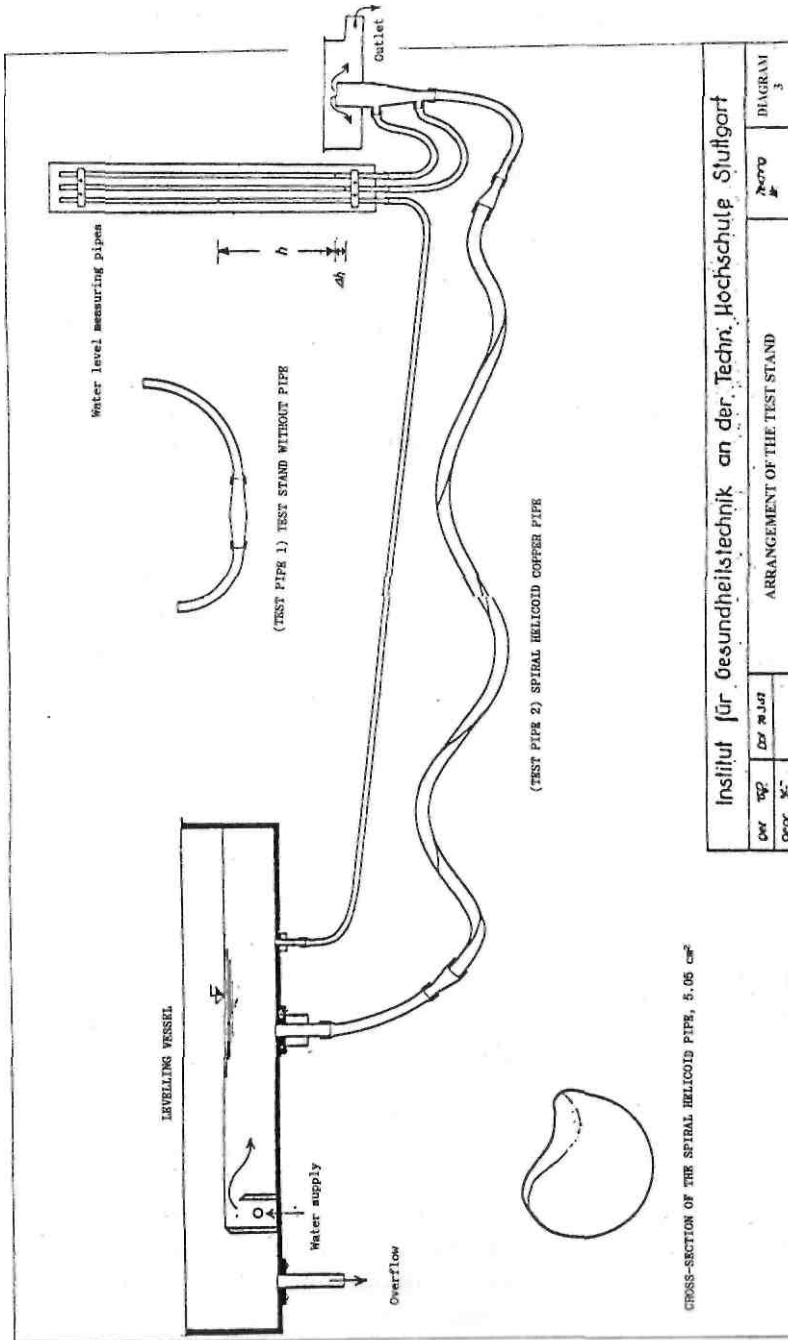

Inst. f. u. r. G. e. s. u. n. d. h. e. i. t. s. t. e. c. h. n. i. k. a. n. d. e. r. T. e. c. h. n. H. o. c. h. s. c. h. u. l. e. S. t. u. t. g. a. r. t.	NO. 70	DIAGRAM
Dr. Ing. P. J. J. J.	3	
Dr. Ing. P. J. J. J.		

Diagram 3

TEST PIPE 3 - Straight Copper Pipe.  
 TEST PIPE 4 - Straight Glass Pipe.  
 TEST PIPE 5 - Smooth Conical Copper Pipe.



TEST PIPE 6 - Conical Spiral Helicoid Copper Pipe



TEST PIPE 7 - Large } Straight Conical Helicoid  
 TEST PIPE 8 - Small } Copper Pipe.

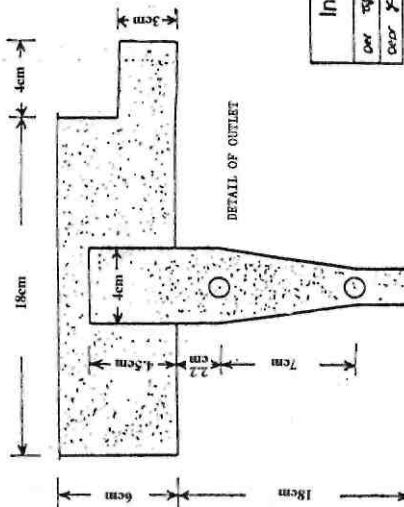

Diagram 4

Institut für Gesundheitstechnik an der Techn. Hochschule Stuttgart		DIAGRAM
OW 100	OW 20103	2070
OW 100		4
THE CONFIGURATION OF THE OTHER TEST-PIPES <small>(This diagram originally belongs to Diagram 3)</small>		

the flow through the pipe, these must therefore have a greater capacity than straight pipes of equal flow section under otherwise identical conditions.

If the processes of motion, above and beyond those initiated by the spiral form of the helicoid pipe, are also synchronous with the momentum arising from the velocity of the through-flow, then, as in the case of the strongly curved space-spiral in the glass pipe, the water ought actually to flow through the helicoid pipe in a freely oscillating manner, i.e. without touching the pipe walls and without the formation of flow-impeding and separating vortices. In this case, as a result of the multiple in-winding flow motion, the pipe wall would then hardly be touched by the water at all. From this it would appear as yet a further step towards hypothetical conclusions, that under very specific preconditions the frictional losses usually occurring in straight pipes could be reduced to zero in the case of the helicoid pipe.

The same hypotheses, however, could also be put forward for the helicoid pipes, which in shape correspond to the weakly curved space-spirals formed inside the straight pipes and with which the spiralling motion of the water is created by a particular configuration of the pipe walls. This screw-shaped indentation in the pipe walls of the straight and curved helicoid pipes, however, by virtue of the flow patterns, will not only aid the formation of the in-winding flow process itself, but will also stabilise its actual configuration - as for example in the case of the rifled barrel of a gun.

The hypothetical conclusions arising from the flow experiments described under Question 1 above, were checked as to their formal logic by measurements of the friction losses and outputs of seven straight or spiral pipes of various cross-section and wall configuration.

From the levelling vessel of Test Stand 1, the water was conducted to the pipes to be tested by a rubber hose of 19 mmOID. A rubber hose of the same diameter served to further conduct the water towards the measuring outlet. This essentially consists of an outlet pipe, enlarging conically from 20 mmOID to 40 mmOID, with two connections for measuring the drop in pressure (Diagrams 3 & 4). The outlet pipe is positioned centrally in a drain catchment. A stopwatch was used to measure the quantity of water flowing through the pipe by the time required to fill a 15 litre measuring vessel. The head of pressure thereby expended, was determined with the aid of three measuring pipes arranged directly adjacent to the measuring outlet. The difference in height  $h$  between the water level of the levelling vessel and the outlet pipe were constantly measured. In addition the pressure gradient  $h$  was measured, arising from the flow through the outlet pipe itself.

The ascertained outputs  $q$  are based on the amount of friction and in Diagram 5 are plotted in the form of a graph using a double logarithmical co-ordinate system. In consideration of the various flow sections  $f$  of the different test pipes, in this case it was not the flow-trough velocity that was

graphically depicted in double logarithmical form, but the measured output  $q$  based on the measured difference in the heights  $h$  of the water levels. The connecting lines of the mutually related measured values, which could be described briefly as  $q - h$  lines, would then have to be straight, taking the Weissbach formulation as a basis, for which the relation

$$h = \frac{c^1}{2g} \times v^2 = c^{11} \times \left(\frac{q}{f}\right)^2 \times q^2 = c \times q^2$$

According to this basic equation the measured values of the pipes of equal flow section and equal roughness of pipe wall must therefore lie along a straight line. In the case of unequal cross-sections, however, the values would certainly be displaced by a factor dependent upon  $1/f^2$ .

As is shown in Diagram 5, the  $q - h$  lines of the different test pipes actually deviate very considerably from the straight line and exhibit a characteristic oscillating course, as for example in the case of the spiral helicoid copper pipe (Test Pipe 2), concerning which the possibility cannot be ruled out that, as determined, the measured values may not have been ascertained with sufficient care.

The smooth, straight copper pipes with constant (Test Pipe 3) and conical (Test Pipe 5) flow sections are those which best follow the hydraulic postulate  $h = c \times q^2$ . With the other test pipes, apart from the oscillating course of the curves, the direction of the connecting lines are characterised by a relation in which the exponent of the output  $q$  is smaller than 2. For the Test Stand (Test Pipe 1) itself, as well as Test Pipe 2 (spiral helicoid pipe), Test Pipe 4 (straight glass pipe) and Test Pipe 7 (straight conical helicoid pipe - larger cross-section) the exponent would be reduced to 1.67. In the case of Test Pipe 6 (conical spiral helicoid pipe) it actually decreases to 1.57 and with Test Pipe 8 (straight, conical helicoid pipe - smaller cross-section) attains the lowest value of 1.51. This permits the conclusion that the winding and twisting of the pipes can exert either a favourable or an unfavourable influence on the flow-through processes according to the prevailing flow-through velocities.

If for example, Test Pipes 6 and 5 are considered, which have the same length and conically shaped flow section, but which differ in relation to their winding and twisting, then the measured value arising from the position of the connecting lines is such, that the winding and twisting of Test Pipe 6 in the area under measurement has an unfavourable effect on its output. The straight, conical copper pipe with smooth walls (No. 5) at equal difference in height of the water levels, delivers more water than the helicoid pipe. The difference in the output, however, constantly decreases with increasing difference in height and at a value of  $h = 28$  cm, is completely cancelled out. With greater differences in height the helicoid pipe (No. 6) delivers a greater

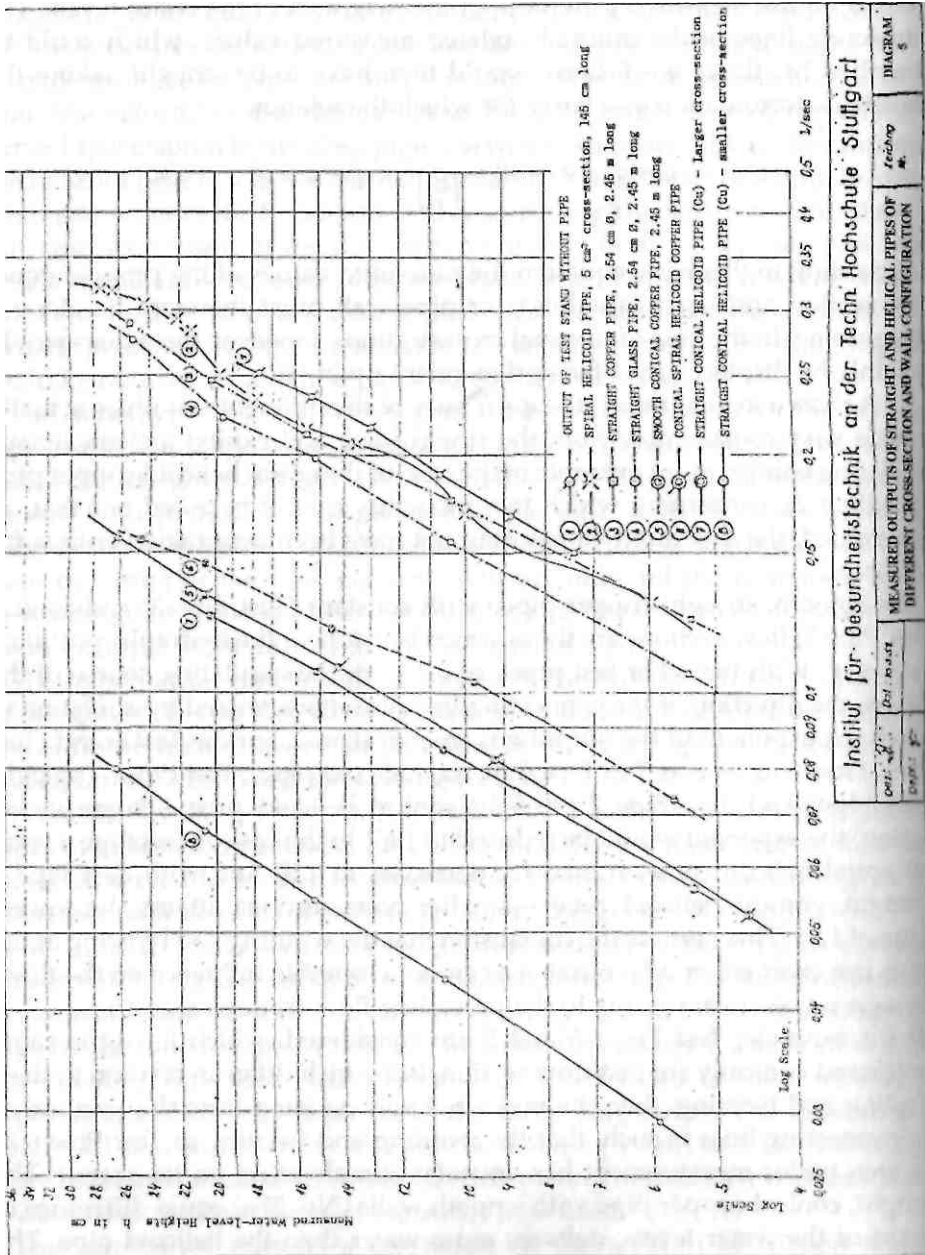

Diagram 5

volume of water than the straight copper pipe (No. 5). The same would also apply to Test Pipe 7, since it would have overtaken the straight, smooth copper pipe (No. 5) at the point where  $ft = 30$  cm with a value of  $q = 0.17$  litres/s. This hypothesis can now be confirmed by the thorough analysis of the measured values of Test Pipes 2, 3 and 4 as corresponding to the facts. The straight glass pipe (No. 4) at an equal difference in height  $h$  always has a smaller output than the straight copper pipe (No. 3) and the spiral helicoid copper pipe (No. 2), but up to a difference in height of 10.5 cm Test Pipe 3 delivers more than the spiral helicoid pipe (No. 2). From here onwards, however, the performance of the spiral helicoid pipe is always superior.

The conclusion, which is derived from the direction of the connecting lines of the measured values of Test Pipes 5, 6 and 7 and concerning the favourable effect of the winding and twisting of these pipes on the flow-through process lying outside the area of measurement, is therefore proven to be correct in the cases of Test Pipes 2, 3 and 4 by the ascertained measured values. The change from the unfavourable to the favourable effects of the winding and twisting of the pipes on the flow-through process to be anticipated beyond the area of measurement of Test Pipes 5, 6 and 7 in comparison to the straight, smooth pipes, already took place in the case of Test Pipes 2, 3 and 4 within the area of measurement. It is therefore appropriate to submit these test pipes to a thorough analysis.

It emerges from the values in Table 1, that the pressure gradients, the  $dh$  values at the outlet of the test stand, exhibit no uniform tendency. In order to determine whether the observed deviations are to be attributed to inaccuracies in measurement, the  $dh$  values based on the output were plotted in graph form (Diagram 6) in a double logarithmical system of co-ordinates. Whereas the connecting lines of the measured values of the straight copper pipe (No. 3) and the straight glass pipe (No. 4) have an even course, those of the spiral helicoid pipe (No. 2) and also of the test stand (No. 1), on the other hand, display characteristic oscillations.

The results of these measurements thus prove that the test stand itself, due to its semi-circular, downwardly pendent configuration, triggers off a similar effect to a coiling of the pipe, which however is completely or to the greatest extent annulled by the intervening incorporation of sections of straight pipe. In the case of the inclusion of the spiral helicoid pipe (No. 2), it is not assumed that the effect of the downward hanging test pipe (No. 1) has been neutralised, but perhaps even further enhanced. Hence, in order to maintain the requisite friction loss in the test pipes required maintain the output  $q$ , it is necessary further to reduce the differences in height of the water levels around the pressure gradients present at the outlet. In Diagram 7 the outputs  $q$  dependent upon the  $(h - dh)$  values are plotted on a double logarithmical co-ordinate system.

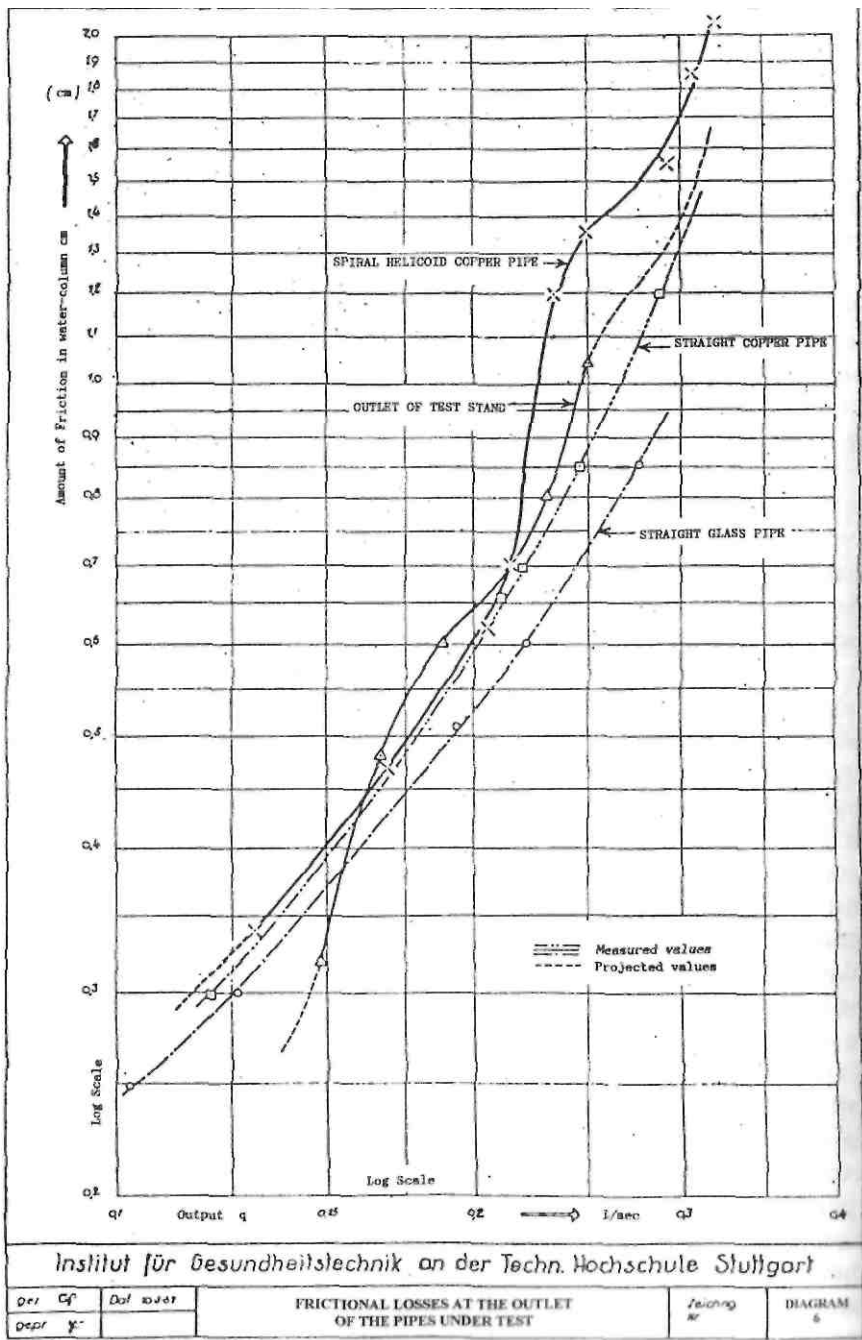

Diagram 6

TABLE 1

Output of straight and spiral pipes

	Output	Flow	h	$\Delta h$	h - $\Delta h$
	q l/s	v cm/s	cm	cm	cm
1) Test Stand without pipes but with conical inlet and outlet of the test pipe and rubber hose of 19 mm $\varnothing$ ID	0.148	52.3	7.35	0.32	7.03
	0.166	58.7	8.81	0.49	8.32
	0.187	66.1	10.70	0.60	10.10
	0.215	76.0	12.85	0.70	12.15
	0.231	81.6	15.30	0.80	14.50
2) Spiral Helicoid Copper Pipe roughly 1.45 m long with a 5.05 cm <sup>2</sup> cross-section of the below form	0.247	87.3	17.48	1.10	16.38
	0.130	25.7	6.0	0.34	5.66
	0.168	3.93	10.05	0.47	9.58
	0.206	40.8	13.7	0.62	13.08
	0.215	42.6	15.7	0.70	15.00
+ These values are obtained from a different series of experiments	0.234	46.3	18.0	1.20	16.80
	0.250	49.5	19.8	1.36	18.44
	+ 0.283	56.1	21.2	2.15	19.95
	0.294	58.3	22.1	1.55	20.55
	0.303	60.06	24.55	1.85	22.70
3) Straight Copper Pipe, 2.54 cm $\varnothing$ , 1.45 m long	0.319	63.38	26.9	2.05	24.85
	+ 0.320	63.4	25.7	2.9	22.8
	0.123	24.4	5.3	0.30	5.0
	0.177	34.6	16.4	0.50	9.9
	0.211	41.7	15.6	0.65	14.95
4) Straight Glass Pipe, 2.54 cm $\varnothing$ , 1.45 m long	0.246	48.7	20.2	0.85	19.75
	0.288	57.0	25.5	1.20	24.70
	q	v	h	$\Delta h$	h - $\Delta h$
	0.106	21.0	5.5	0.25	5.25
	0.155	30.7	16.5	0.30	10.20
0.192	38.0	15.6	0.55	14.75	
5) Smooth Conical Copper Pipe, 1.45 m long.	0.222	43.9	19.6	6.60	19.00
	0.275	54.4	25.3	0.85	24.45
	0.073	-	5.65	0.20	5.45
	0.1035	-	9.80	0.22	9.58
	0.1200	-	14.65	0.20	14.45
6) Conical Spiral Helicoid Copper Pipe 1.45 m long	0.1445	-	20.70	0.30	20.40
	0.1555	-	24.75	0.42	24.33
	0.0525	-	4.60	0.15	4.45
	0.0820	-	9.30	0.23	9.07
	0.1075	-	14.25	0.30	13.95
7) Straight Conical Helicoid Copper pipe of larger cross-section, 1.45 m long	0.1320	-	20.55	0.38	20.17
	0.1565	-	26.40	0.62	25.78
	0.0565	-	5.35	0.17	5.18
	0.0844	-	10.70	0.32	10.38
	0.1060	-	15.20	0.38	14.82
8) Straight Conical Helicoid Copper Pipe of smaller cross-section, 1.45 m long	0.1240	-	20.40	0.22	21.18
	0.0292	-	5.90	0.10	5.80
	0.0438	-	10.70	0.10	10.60
	0.0545	-	15.70	0.10	15.20
	0.0665	-	20.70	0.13	20.57
	0.0788	-	26.40	0.18	26.22



The connecting lines of the mutually related measured values of the inlet and outlet of the test stand (No. 1), as well as those of the straight glass and copper pipes, now have a more even course than before. The connecting line, whose measured values emulate those of the spiral helicoid pipe, again exhibits the characteristic oscillation of the latter. The results of measurement evened out in this way are then used to determine the friction losses of the 1.45 m long test pipes. As is indicated in Diagram 7, each one of the ordinates between the  $q - h$  lines of the test stand and the test pipes are ascertained and compiled in Table 2.

TABLE 2

Output and Friction Losses of Straight and Spiral Test Pipes of Glass and Copper.

Output $q$	Frictional Losses in		Straight Glass Pipe
	Spiral Helicoid ↓ Copper Pipe	Straight ↓ Copper Pipe	
l/sec	cm	cm	cm
0.12	0.10	0.5	1.85
0.13	0.19	0.20	2.07
0.14	0.00	0.23	2.20
0.15	0.40	0.33	2.48
0.16	0.95	0.45	2.85
0.17	0.95	0.70	3.25
0.18	0.65	1.20	3.75
0.19	0.45	1.85	4.25
0.20	0.95	2.25	4.65
0.21	2.05	2.55	5.05
0.22	2.50	2.65	5.30
0.23	2.45	2.95	5.45
0.24	2.10	3.10	5.60
0.25	1.70	3.24	5.79
0.26	1.25	3.35	6.00
0.27	0.80	3.50	6.20
0.28	0.35	3.75	6.65
0.29	0.00	4.00	7.00
0.30	0.00	4.30	7.30
0.31	0.10	-	-
0.32	0.80	4.90	7.30
0.34	3.50	4.90	-
0.36	4.60	4.90	-
0.38	3.70	5.05	-
0.40	2.50	5.38	-
0.42	1.60	5.80	-
0.44	0.70	6.50	-

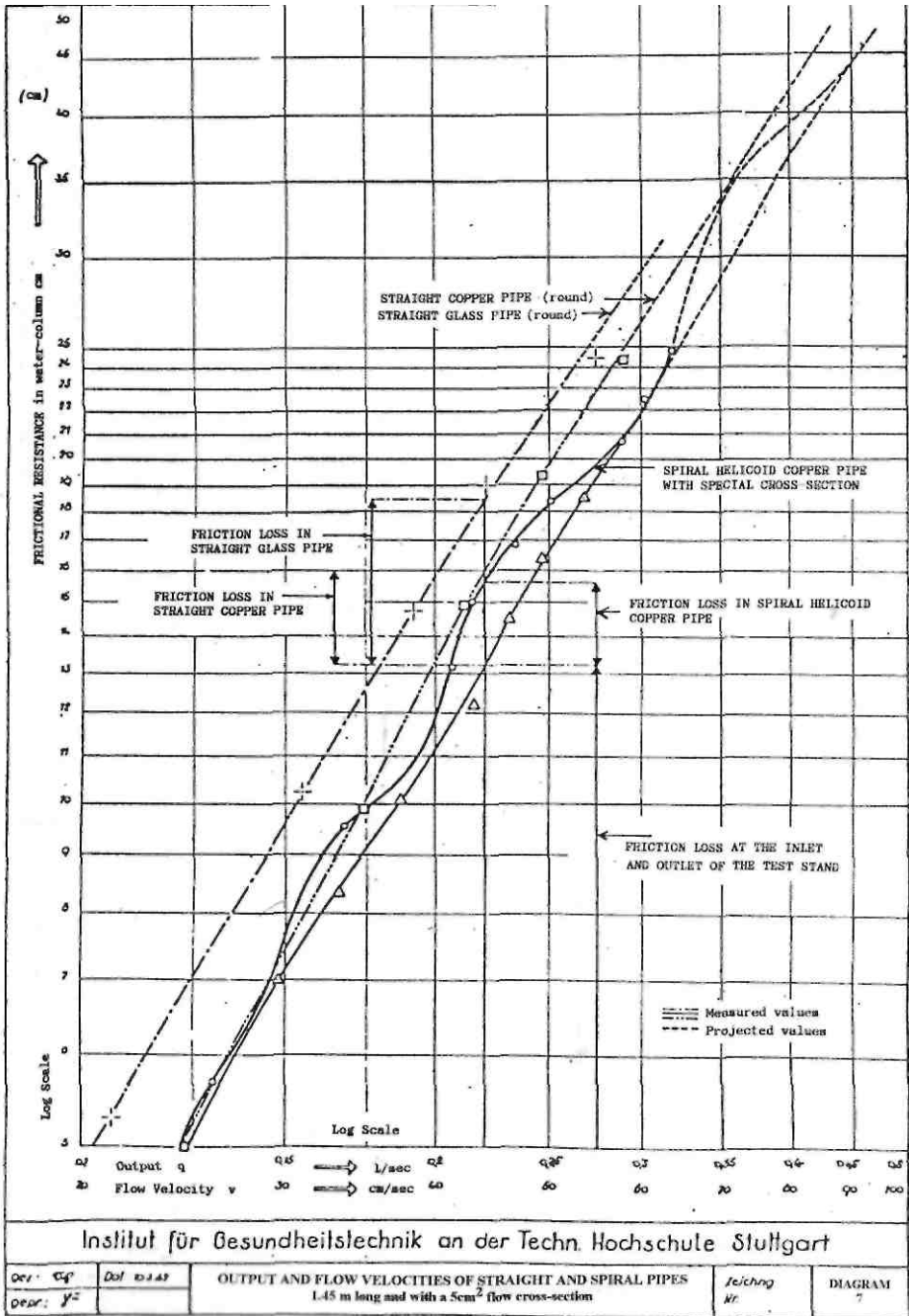

Diagram 7

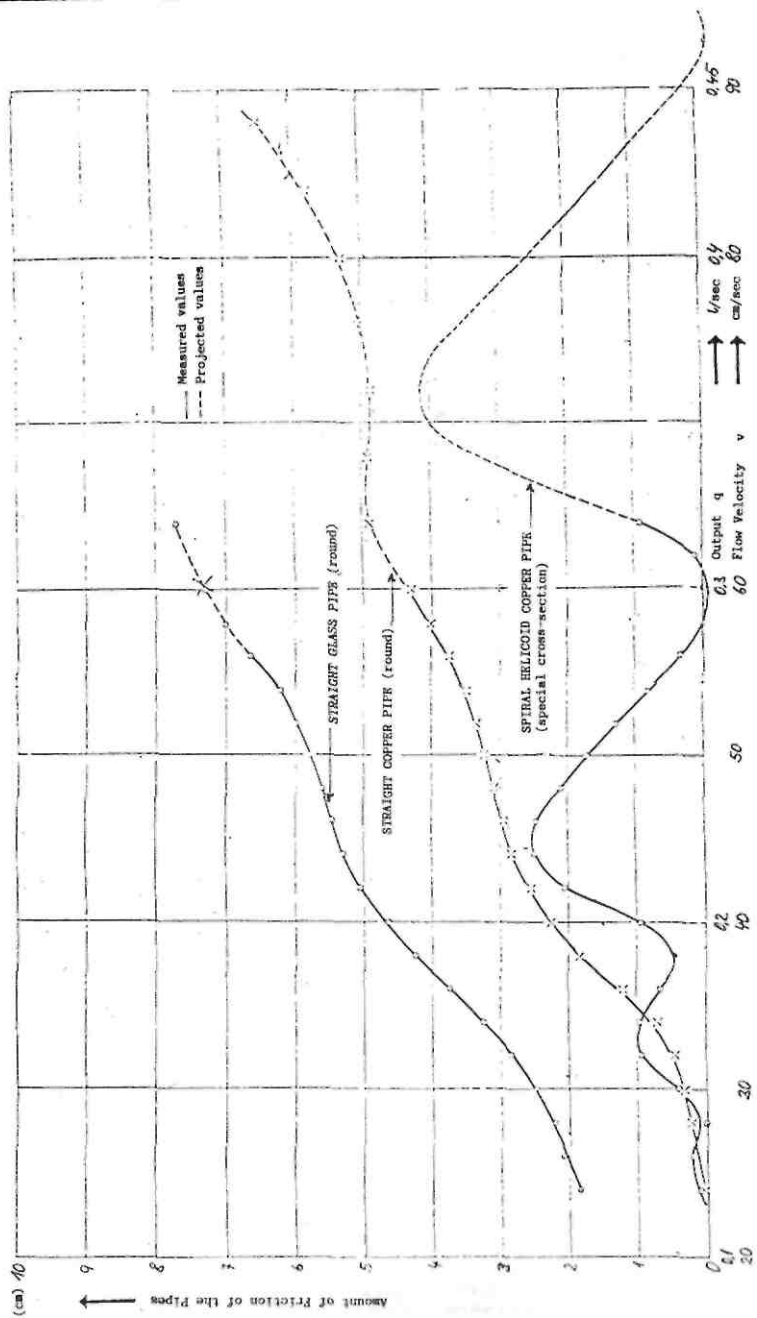
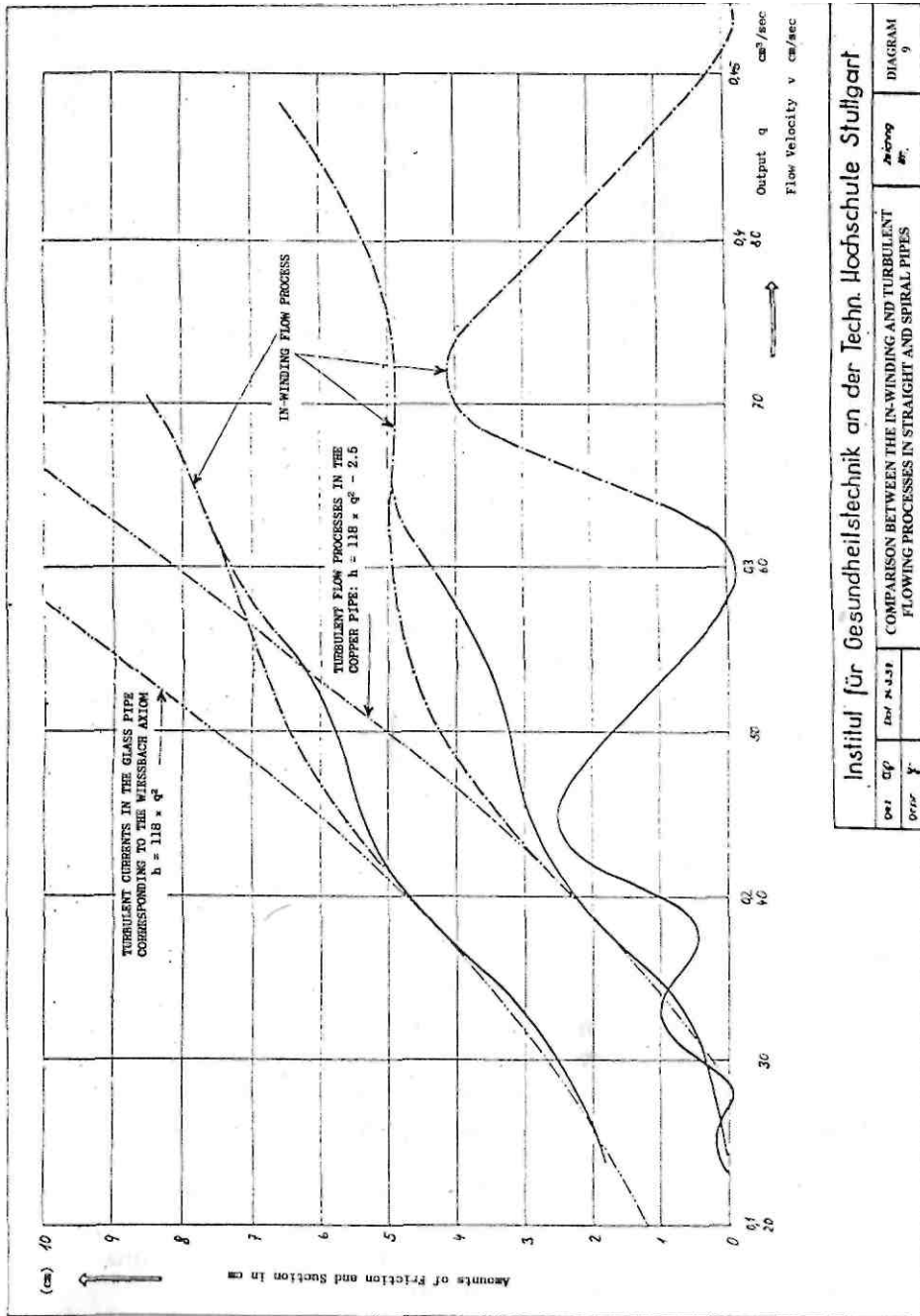

Diagram 8

Institut für Gesundheitstechnik an der Techn. Hochschule Stuttgart

Dir: cp	Det: H.J.S.R.	Output q	Flow Velocity v	U/sec 64	cm/sec 80	Diagram 8
Dir: f		OUTPUT AND FLOW VELOCITIES OF STRAIGHT AND SPIRAL PIPES				Diagram 8
		1.45 m long and with a 5cm <sup>2</sup> flow cross-section				



Instilut für Gesundheitslechnik an der Techn. Hochschule Stuttgart		DIAGRAM 9
Ort: GfP	Dat: 2.1.58	
Ort: S		Abtrag Nr.
COMPARISON BETWEEN THE IN-WINDING AND TURBULENT FLOWING PROCESSES IN STRAIGHT AND SPIRAL PIPES		

Diagram 9

In Diagram 8 the output of the pipes are plotted in Cartesian co-ordinates based on the amount of friction and the relevant measured values related vertically and horizontally. It is to be noticed that all the connecting lines exhibit a characteristic oscillating course, which is most clearly pronounced in the case of the spiral helicoid pipe (No. 2).

From the configuration of the three curves, it indisputably emerges that with equal amounts of friction, the spiral helicoid copper pipe has a greater output than a straight copper pipe of equal length and flow cross-section. These findings, not to be anticipated in relation to the turbulent flow processes currently considered to be correct, however can be considered as a confirmation of the hypotheses put forward on the basis of the flowing processes evolving in straight pipes, due to the screw-shaped form of the water inflow and which were addressed in detail in Question 1.

With the synchronisation of the speed and form of flow of the water with the space-spiral of the spiral helicoid pipe, a decrease down to zero in the amount of friction was factually observed.

The total disappearance of friction, however, can only then occur, when the kinetic energy of the water flowing in the spiral helicoid pipe and co-acting with the spiralling motion of the same, induced at the inlet or by the rifling of the pipe walls, generates a free spacial oscillation of the water precisely attuned to the coiled configuration of the test pipe.

In this connection, however, the centripetally directed suctional force arising from the in-winding flowing process also contributes decisively. In relation to the experimental models examined under Question 1, this is actually so strong, that the end-weighted silk threads were formed into a 3-dimensional space-spiral corresponding to the flow process, against the gravitational attraction acting upon them. Whereas the self-same weakly curved flow processes with strong, centripetally directed in-winding motion and the strongly curved flow processes with slighter in-winding action, observed in the vertical glass pipe in Test Stand 1, were superimposed in a mutually impeding fashion, both of these centrifugally acting oscillating forces and centripetally acting in-winding forces in the spiral helicoid pipe could become united in a mutually supporting harmonic action, when the kinetic energy of the water corresponds to the combined form of the helix and the rifling, through the conduction of the water along a 3-dimensional space-spiral and a screw-shaped pipe wall.

In the instance of the spiral helicoid pipe (No. 2), this was the case with the following outputs and flow velocities.

The amount of friction in the spiral helicoid pipe approaches zero			
when $q = 0.14$ l/s	or	$v = 0.28$ m/s	and
when $q = 0.19$ l/s	or	$v = 0.39$ m/s	and
when $q = 0.38$ l/s	or	$v = 0.60$ m/s	and
when $q = 0.46$ l/s	or	$v = 0.92$ m/s	

and it reached its highest values

when  $q = 0.127$  1/s or  $v = 0.254$  m/s and

when  $q = 0.165$  1/s or  $v = 0.330$  m/s and

when  $q = 0.225$  1/s or  $v = 0.430$  m / s and

when  $q = 0.360$  1/s or  $v = \dots$ .

In Diagram 9, which is a more comprehensive complement to Diagram 8, it is noticeable that the output of both smooth and straight pipes are subjected to a rhythmical oscillation very similar to that of the spiral helicoid pipe. This is presumably to be put down to the spiralling of the water at the inlet of the test stand and to its U-shaped formation. The course of the connecting lines conforming to the measured values even permits the presumption that we are here concerned with two output-related oscillations lying one over the other, which probably arise from the combined action of the torsional motion and the configuration of the test stand.

Furthermore it is to be noted, that the q-h line of the straight glass pipe (No. 4) in the output range of 0.13 to 0.20 1/s, fairly precisely follows the curve, which in accordance with the Weissbach principle is satisfied by the relation

$$H = 118 \times q^2$$

In the immediately following zone of greater output, though, the q-h line of the glass pipe deviates very markedly from this fundamental Weissbach equation. The outputs increase much faster with increasing amounts of friction than could be anticipated according to Weissbach's basic law, as a consequence of the in-winding flow process generated by the spiralling at the inlet and the pendent U-shaped form of the test stand.

The lower section of the q - h line for the straight copper pipe runs exactly parallel to that of the glass pipe; it is therefore displaced downwards in relation to the friction level  $h = 2.5$  cm. The friction loss of the copper pipe in the area where  $q = 0.13$  to  $0.20$  1/s therefore amounts to only  $h = 118 \times q^2 - 2.5$ , despite a greater roughness of the pipe walls than the glass pipe,.

This reduction in the level of friction when the water flows through the copper pipes can only be explained by the fact, that copper is more favourable to the formation of the in-winding flow process than glass. As was already detected earlier, suctional forces are exerted on the water through this in-winding motion, which lead to the observed reduction in friction. The magnitude of this suctional force, therefore, can now be determined provisionally by means of the very closely associated decrease in friction that must attach itself to the water in the areas of reduced friction. The in-winding flowing motion generated in the copper pipe produces an adsuctional capacity  $A$ , where

$$A = 2,5 q \text{ in cm g/s}$$

in the lower region of the q - h line and which rises even further with increasing output from 325 to 500 cm g/s.

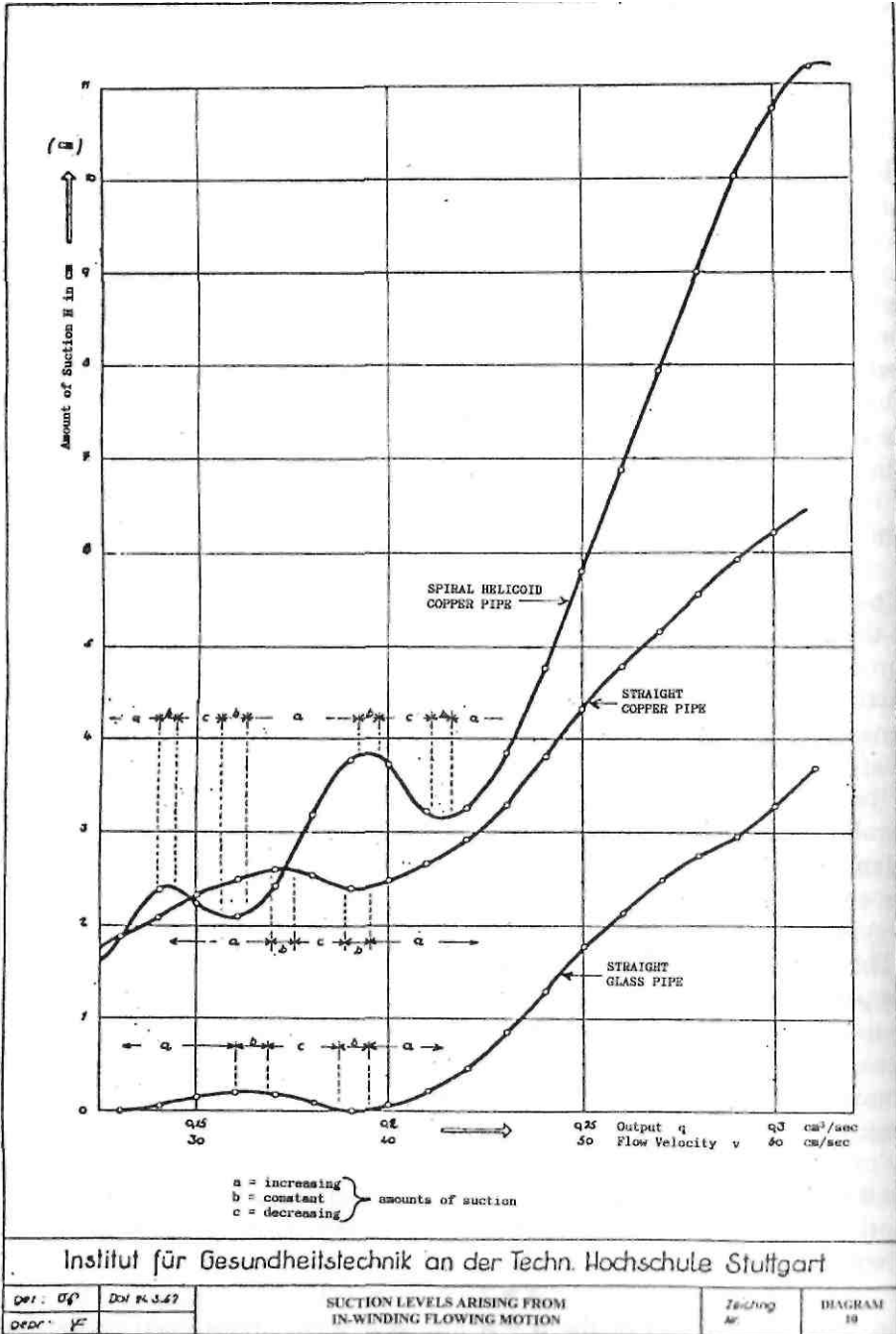

Diagram 10

Without erring, it can furthermore be assumed that the Weissbach basic equation for frictional loss in pipes should also apply with outputs greater than 0.2 l/s, if at the inlet to the test pipes the formation of torsional motion could be prevented. Hence it is possible further to extend the parabola for the friction levels of the form  $h = 118 \times q = 0.2$  l/s. The differences in the ordinates between these parabolas and the  $q - h$  lines of the three test pipes, then represent the reduction in the amounts of friction normally applicable and as a consequence of this, can also be defined as the amounts of suction that the in-winding flowing motion of the water creates and which, as described above, form the basis for the calculation of the suction capacity.

To illustrate these trains of thought, the amounts of suction based on the output were plotted in graph form in Diagram 10. With their aid the suction capacities  $A$  were determined, which in Diagram 11 were likewise plotted as  $q - A$  curves based on the output.

In the case of the glass pipe, the suction capacity constantly increases towards  $A = 850$  cm g/s up to an output of  $q = 300$  cm<sup>3</sup>/s. The copper pipe, however, under the same delivery volume, now develops a suction capacity of  $A = 1860$  cm g/s. The material of the pipe has thus intensified the suction capacity exerted on the water by  $1860 - 850 = 1010$  cm g/s. With an output of 310 cm<sup>3</sup>/s the suction capacity of the spiral helicoid pipe reaches its maximum value in the examined area of measurement, where  $A = 310 \times 11.1 = 3450$  cm g/s. It is therefore 4.05 times as large as that of the glass pipe and 1.85 times larger than that of the straight copper pipe.

The course of the  $q - h$  and  $q - A$  lines in respect of the three test pipes shown in Diagrams 10 and 11 makes the rhythmical fluctuation of increasing, constant and decreasing amounts of suction with increasing output clearly apparent.

In the zones of increasing amounts of suction and suction capacity, the amount of suction arising from the multiple in-winding flowing motion of the water is always greater than the amount of friction to which, according to the Weissbach principle, the normal turbulent flow processes in pipes would give rise. The interpretation and evaluation of the observations selected above hence also permit the hypothetical conclusion, that the synchronisation of the kinetic energy of the flowing water generates more energy due to the spiralling and twisting of the pipes than is required to overcome the frictional losses obtaining. A constantly increasing acceleration of the motion of the water would therefore have to occur.

This acceleration, however, cannot assume unlimited proportions, since the zones of increasing amounts of suction and suction capacity are repeatedly interrupted by those of constant and decreasing suction capacity. These interruptions only occur, when the optimum synchronisation of all the flow processes is exceeded, leading to the accentuation of the dynamic translatory



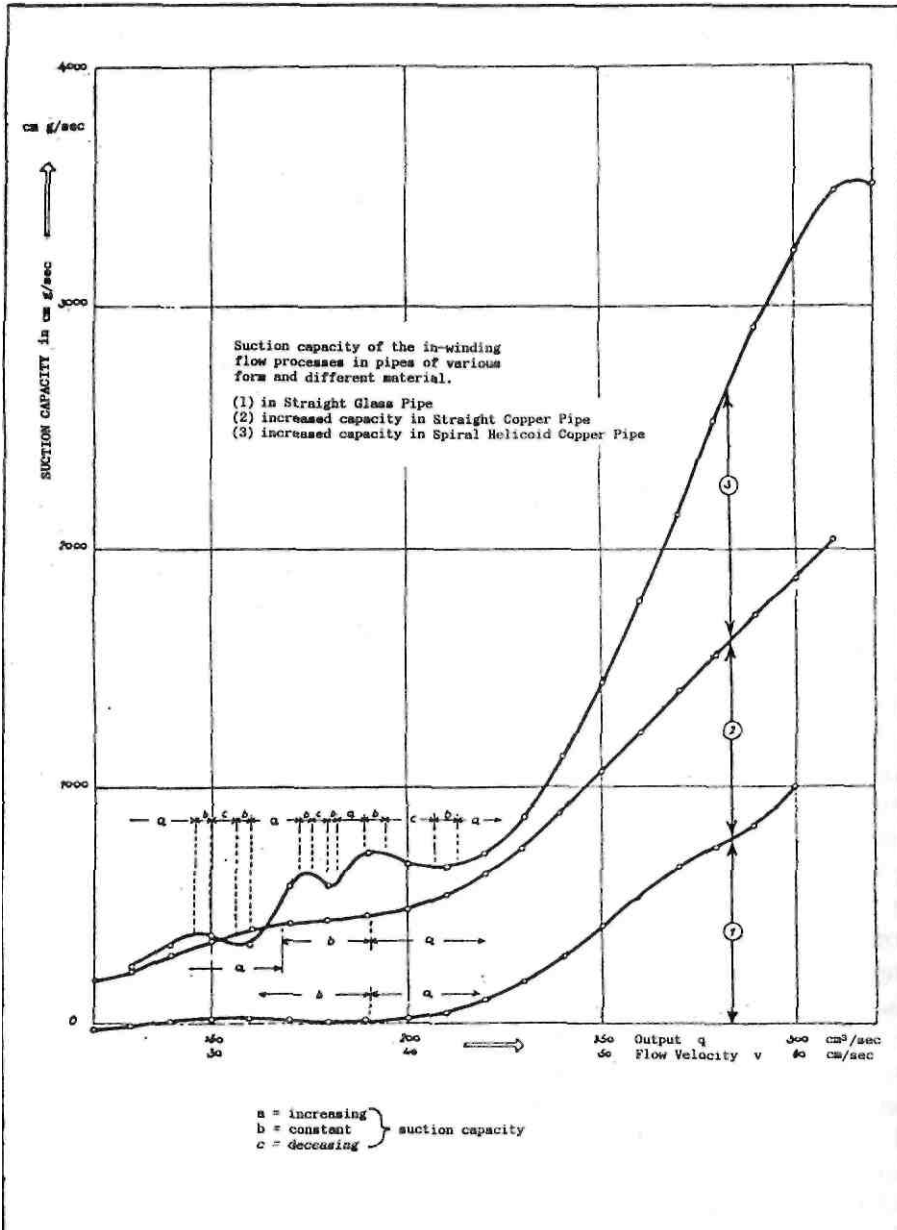

Institut für Gesundheitstechnik an der Techn. Hochschule Stuttgart

Ver. 1/57	Daf. 14.8.57	SUCTION CAPACITY OF THE IN-WINDING FLOWING MOTION IN PIPES OF VARIOUS FORM AND DIFFERENT MATERIAL	Zeichn. Nr.	DIAGRAM 11
-----------	--------------	---	-------------	------------

Diagram 11

component at the expense of the rotational and oscillatory motions, whereby an asynchronous combined action of the various superimposed kinetic processes comes about. The course of the curves demonstrates that in the investigated area of measurement, these consist of relatively long sections of increasing suction capacity, interrupted by shorter sections of constant and decreasing suction capacity. In the areas of constant amounts of suction and suction capacity, the gain in energy arising from the in-winding flowing motion of the water - corresponding to the observation in the glass pipe - is just as large as the consumption of energy, which the normal turbulent flow would cause. The gain in energy however, as in the case of the copper pipe, can also be of a greater constant amount than the normal consumption of energy in turbulent flow processes.

In the zones of decreasing amounts of suction and suction capacity, the kinetic energy of the flowing and rotating water is not synchronised with its oscillating motion. Through this the turbulence of the currents is intensified to the extent that the consumption of energy required to convey the water in the pipes is much greater than the energy gain arising from the in-winding motion of the water.

Therefore the fact cannot be disregarded, that the representation of the observations in the above form may not reflect reality. It was employed first and foremost in order to obtain an initial overview of the magnitude of the forces capable of giving rise to the phenomenon of the in-winding flowing motion. It must be left to further experiments to understand their magnitude, form and effect more precisely. Since their existence has now become known and their conscious technical application lies within the bounds of possibility, they will be awarded a revolutionising importance in the areas of the handling and conveyance of liquid and gaseous media.

Since the courses of the  $q - h$ ,  $q - H$  and  $q - A$  lines permit the recognition of the superiority of the spiral helicoid pipe vis-a-vis the straight copper pipe and the inferiority of the glass pipe with respect to the latter, Questions 2 and 3 can be collectively answered as follows:

The form and the material of the pipes are of decisive importance for the formation of the in-winding flow motion and the suction capacity and amount of suction generated by it.

To Question 4:

**The Structural Change in the Water as a Consequence of the Multiple In-Winding Flowing Motion.**

Even if no exact measurements can be undertaken concerning the structural changes in the water as a result of the in-winding flow motion, it is very clear

from the experimental models under Question 1, that in straight pipes - even those with flow processes still flowing synchronously - this in-winding flow motion is already capable of giving rise to flocculations, which apart from the mechanical agglomeration of solid matter, must also be attributed to electro-physical effects.

The fact established under 2 and 3, that the material of the pipe exerts an extraordinarily large influence on the formation of the in-winding flowing motion of the water, cannot rest on purely hydrodynamic effects alone, but presumably will also have to be ascribed above all to electro-physical effects arising from a greater reactive capacity of copper in its interaction with the water.

These conclusions are also confirmed by the observations made in connection with the flow process, where silk threads with transverse copper filaments were incorporated and which was reported in 1. The darkening effects of the copper filaments, which were not present at a state of rest and which first appeared in the immediate vicinity of the copper filaments under the full motion of the water, indicate a slightly reduced light transmittance of the water at these locations. This decreased light transmittance, however, probably cannot be ascribed to the form of the flow caused by the copper filaments alone. It is to be assumed that here too electro-physical effects co-act, which lead to a localised change in the light transmittance of the water. It is hence quite conceivable that the electro-physical processes detected through the flocculation and increase in the in-winding flow as well as the reduction of light transmittance, are also able to cause structural changes in the water itself.

To Question 5:

The Prevention of Encrustation.

In the answering of Questions 2 and 3, it was determined that water moves itself in a freely oscillating manner in the spiral helicoid pipe, if the kinetic energy of the flowing water is synchronised with the meander of the space-spiral. It can hence be assumed with the greatest probability, that under these conditions no encrustation of the pipe walls will occur. This should not necessarily also apply in the case where the liquid conducted through the pipe would normally have a tendency towards the precipitation of its dissolved salts.

Stuttgart, the 15th of March 1952

Signed: Popel, Dr. Honoris Causa,  
Full Professor, Dr. - Eng. habitatus.  
Director of the Institute of Hygiene,  
Stuttgart University of Technology,  
Germany.

#### REMARKS:

1. In the above transcription of the expert opinion from Stuttgart University of Technology only a few minor, inessential deletions were made.
2. The underlining of various sections of the text were made later in the transcription.
3. The photographs Nos. 3 - 9A concerning the kinetic effects in the vertical glass test pipe, which showed the entwining of the silk threads, the iron filings and hydrophobic substances, inter alia, were not reproduced due to their poor quality. However these effects are clearly interpreted in the text.
4. The financial costs of this expert opinion (materials, personnel and fees) including the earlier costs of research, development and prototypes, were at the expense of the client.
5. This expert opinion was primarily concerned with the subsequent scientific confirmation of the earlier research and development findings of Viktor Schauburger and of the evaluation data of previous series of experiments in which Walter Schauburger was also involved.

In attestation of the correctness of the transcription

Signed: Ingeborg Schauburger.

Editor's Note: Due to the deletion of the photographs 3-9A mentioned in 3. above, the various diagrams have been renumbered in sequence from 1-11 to avoid confusion.